



UNIVERSITY of STRATHCLYDE  
**POWER NETWORKS  
DEMONSTRATION CENTRE**

# Experimental Evaluation of PV Inverter Performance during Islanding and Frequency Disturbance Conditions



Document No.: PNDC/ENA-001/FR-01

Commercial in Confidence

**04 December 2015**

Copyright © The University of Strathclyde 2015



---

**DOCUMENT INFORMATION**

---

Title:	Experimental Evaluation of PV Inverter Performance during Islanding and Frequency Disturbance Conditions
Document No.:	PNDC/ENA-001/FR-01
Classification:	Unrestricted
Client(s):	Energy Networks Association

---

**DOCUMENT AUTHORIZING, REVIEW AND APPROVAL**

---

Prepared By:	Ibrahim Abdulhadi
Reviewed By:	Adam Dyśko, Alan Dunn
Approved By:	Federico Coffele
Date of Issue	04/12/2015

---

**DOCUMENT AMENDED RECORD**

---

Document Number	Date of Issue	Changes from Previous Version	Author
PNDC/ENA-001/FR-01	07/10/2015	First draft of the report	Ibrahim Abdulhadi
PNDC/ENA-001/FR-01	19/10/2015	Second draft of the report	Ibrahim Abdulhadi
PNDC/ENA-001/FR-01	04/12/2015	Final version of the report	Ibrahim Abdulhadi

---

COPYRIGHT ©The University of Strathclyde 2015

This document and its contents are the property of the University of Strathclyde and are confidential and protected by copyright. Disclosure, use or copying of this document in whole or in part without the written permission of the University constitutes an infringement of the University's proprietary rights.



## EXECUTIVE SUMMARY

Testing of five low voltage photovoltaic inverters has been performed at the PNDC to determine:

- Their ability to successfully detect an island and trip accordingly when the inverter power output and local load are closely matched; and
- Their ability to remain stable (not spuriously trip) during rate of change and voltage vector shift events.

Inverters were tested individually and in pairs. All tests were successful in the sense that all inverters tripped during an island while remaining stable during grid disturbances of 1Hz/s rate-of-change-of-frequency (RoCoF) and 5.5° voltage vector shift.

Changes in active and reactive power output of some of the inverters were observed during these events. Active power output reduction was observed for the ABB inverter under test for events of at least 0.7Hz/s over a 1.5Hz frequency band. The reduction lasted for around 1s. Momentary reactive power changes were symptomatic of all transformer-less inverters (i.e. SMA and ABB inverters) during RoCoF events.

## Contents

<b>EXECUTIVE SUMMARY .....</b>	<b>2</b>
<b>LIST OF FIGURES .....</b>	<b>4</b>
<b>LIST OF TABLES .....</b>	<b>8</b>
<b>1 INTRODUCTION .....</b>	<b>9</b>
<b>2 TEST SETUP .....</b>	<b>10</b>
2.1 PV INVERTERS UNDER TEST .....	10
2.2 PV EMULATORS USED TO SUPPLY INVERTERS UNDER TEST .....	10
2.3 TEST CATEGORY 1: PV INVERTER SENSITIVITY TO ISLANDING .....	11
2.4 TEST CATEGORY 2: PV INVERTER STABILITY AGAINST RATE OF CHANGE OF FREQUENCY DISTURBANCES .....	11
2.5 TEST CATEGORY 3: PV INVERTER STABILITY AGAINST SIMULTANEOUS FREQUENCY AND VOLTAGE DISTURBANCES .....	12
<b>3 TESTING RESULTS.....</b>	<b>13</b>
3.1 TEST CATEGORY 1.....	13
3.2 TEST CATEGORY 2.....	15
3.2.1 <i>Verification of applied RoCoF disturbance</i> .....	15
3.2.2 <i>Discussion of test findings</i> .....	15
3.2.3 <i>ABB inverter active power output drop during RoCoF events</i> .....	16
3.3 TEST CATEGORY 3.....	17
3.3.1 <i>Verification of applied voltage phase shift</i> .....	17
3.3.2 <i>Discussion of test findings</i> .....	17
<b>4 CONCLUSIONS .....</b>	<b>18</b>
<b>5 REFERENCES.....</b>	<b>19</b>
<b>APPENDIX A – GRAPHS OF CATEGORY 1 TEST MEASUREMENTS.....</b>	<b>20</b>
<b>APPENDIX B – GRAPHS OF CATEGORY 2 TEST MEASUREMENTS.....</b>	<b>34</b>
<b>APPENDIX C – GRAPHS OF CATEGORY 3 TEST MEASUREMENTS.....</b>	<b>52</b>

## List of Figures

<b>Figure 1 Network configuration for islanding tests.....</b>	<b>11</b>
<b>Figure 2 Network configuration for RoCoF disturbances.....</b>	<b>12</b>
<b>Figure 3 Network configuration for simultaneous frequency and voltage phase disturbances .....</b>	<b>12</b>
<b>Figure 4 Typical frequency profiles during test category 2 (a) 1Hz/s ramp up and (b) 1Hz/s ramp down.....</b>	<b>15</b>
<b>Figure 5 Typical frequency profile during test category 3 .....</b>	<b>17</b>
<b>Figure 6 ABB inverter output current and voltage .....</b>	<b>21</b>
<b>Figure 7 ABB inverter output active and reactive powers .....</b>	<b>21</b>
<b>Figure 8 PCC current and voltage .....</b>	<b>21</b>
<b>Figure 9 PCC active and reactive power flow.....</b>	<b>21</b>
<b>Figure 10 Kaco inverter output current and voltage .....</b>	<b>22</b>
<b>Figure 11 Kaco inverter output active and reactive powers.....</b>	<b>22</b>
<b>Figure 12 PCC current and voltage .....</b>	<b>22</b>
<b>Figure 13 PCC active and reactive power flow.....</b>	<b>22</b>
<b>Figure 14 Fronius inverter output current and voltage.....</b>	<b>23</b>
<b>Figure 15 Fronius inverter output active and reactive powers .....</b>	<b>23</b>
<b>Figure 16 PCC current and voltage .....</b>	<b>23</b>
<b>Figure 17 PCC active and reactive power flow.....</b>	<b>23</b>
<b>Figure 18 SMA inverter output current and voltage .....</b>	<b>24</b>
<b>Figure 19 SMA inverter output active and reactive powers.....</b>	<b>24</b>
<b>Figure 20 PCC current and voltage .....</b>	<b>24</b>
<b>Figure 21 PCC active and reactive power flow.....</b>	<b>24</b>
<b>Figure 22 Three phase SMA inverter output current and voltage .....</b>	<b>25</b>
<b>Figure 23 Three phase SMA inverter output active and reactive powers.....</b>	<b>25</b>
<b>Figure 24 PCC current and voltage .....</b>	<b>25</b>
<b>Figure 25 PCC active and reactive power flow.....</b>	<b>25</b>
<b>Figure 26 ABB inverter output current and voltage .....</b>	<b>26</b>
<b>Figure 27 ABB inverter output active and reactive powers .....</b>	<b>26</b>
<b>Figure 28 SMA inverter output current and voltage .....</b>	<b>26</b>
<b>Figure 29 SMA inverter output active and reactive power .....</b>	<b>26</b>
<b>Figure 30 PCC current and voltage .....</b>	<b>27</b>
<b>Figure 31 PCC active and reactive powers flow .....</b>	<b>27</b>
<b>Figure 32 ABB inverter output current and voltage .....</b>	<b>28</b>

<b>Figure 33 ABB inverter output active and reactive powers .....</b>	<b>28</b>
<b>Figure 34 Kaco inverter output current and voltage .....</b>	<b>28</b>
<b>Figure 35 Kaco inverter output active and reactive power .....</b>	<b>28</b>
<b>Figure 36 PCC current and voltage .....</b>	<b>29</b>
<b>Figure 37 PCC active and reactive powers flow .....</b>	<b>29</b>
<b>Figure 38 Fronius inverter output current and voltage .....</b>	<b>30</b>
<b>Figure 39 Fronius inverter output active and reactive powers .....</b>	<b>30</b>
<b>Figure 40 Kaco inverter output current and voltage .....</b>	<b>30</b>
<b>Figure 41 Kaco inverter output active and reactive power .....</b>	<b>30</b>
<b>Figure 42 PCC current and voltage .....</b>	<b>31</b>
<b>Figure 43 PCC active and reactive powers flow .....</b>	<b>31</b>
<b>Figure 44 Kaco inverter output current and voltage .....</b>	<b>32</b>
<b>Figure 45 Kaco inverter output active and reactive powers .....</b>	<b>32</b>
<b>Figure 46 SMA inverter output current and voltage .....</b>	<b>32</b>
<b>Figure 47 SMA inverter output active and reactive power .....</b>	<b>32</b>
<b>Figure 48 PCC current and voltage .....</b>	<b>33</b>
<b>Figure 49 PCC active and reactive powers flow .....</b>	<b>33</b>
<b>Figure 50 Average frequency during +1Hz/s event .....</b>	<b>35</b>
<b>Figure 51 Average frequency during -1Hz/s event .....</b>	<b>35</b>
<b>Figure 52 ABB inverter output active and reactive powers during +1Hz/s event .....</b>	<b>35</b>
<b>Figure 53 ABB inverter output active and reactive powers during -1Hz/s event .....</b>	<b>35</b>
<b>Figure 54 Average frequency during +0.6Hz/s event .....</b>	<b>36</b>
<b>Figure 55 Average frequency during -0.6Hz/s event .....</b>	<b>36</b>
<b>Figure 56 ABB inverter output active and reactive powers during +0.6Hz/s event .....</b>	<b>36</b>
<b>Figure 57 ABB inverter output active and reactive powers during -0.6Hz/s event .....</b>	<b>36</b>
<b>Figure 58 Average frequency during +0.7Hz/s event with 2Hz deviation .....</b>	<b>37</b>
<b>Figure 59 Average frequency during -0.7Hz/s event with 2Hz deviation .....</b>	<b>37</b>
<b>Figure 60 ABB inverter output active and reactive powers during +0.7Hz/s event with 2Hz deviation .....</b>	<b>37</b>
<b>Figure 61 ABB inverter output active and reactive powers during -0.7Hz/s event with 2Hz deviation .....</b>	<b>37</b>
<b>Figure 62 Average frequency during +0.7Hz/s event 1.5Hz frequency deviation .....</b>	<b>38</b>
<b>Figure 63 Average frequency during -0.7Hz/s event 1.5Hz frequency deviation .....</b>	<b>38</b>
<b>Figure 64 ABB inverter output active and reactive powers during +0.7Hz/s event 1.5Hz frequency deviation .....</b>	<b>38</b>
<b>Figure 65 ABB inverter output active and reactive powers during -0.7Hz/s event 1.5Hz frequency deviation .....</b>	<b>38</b>
<b>Figure 66 Average frequency during +0.8Hz/s event .....</b>	<b>39</b>

<b>Figure 67 Average frequency during -0.8Hz/s event .....</b>	<b>39</b>
<b>Figure 68 ABB inverter output active and reactive powers during +0.8Hz/s event .....</b>	<b>39</b>
<b>Figure 69 ABB inverter output active and reactive powers during -0.8Hz/s event .....</b>	<b>39</b>
<b>Figure 70 Average frequency during +1Hz/s event .....</b>	<b>40</b>
<b>Figure 71 Average frequency during -1Hz/s event .....</b>	<b>40</b>
<b>Figure 72 Kaco inverter output active and reactive powers during +1Hz/s event .....</b>	<b>40</b>
<b>Figure 73 Kaco inverter output active and reactive powers during -1Hz/s event .....</b>	<b>40</b>
<b>Figure 74 Average frequency during +1Hz/s event .....</b>	<b>41</b>
<b>Figure 75 Average frequency during -1Hz/s event .....</b>	<b>41</b>
<b>Figure 76 Fronius inverter output active and reactive powers during +1Hz/s event .....</b>	<b>41</b>
<b>Figure 77 Fronius inverter output active and reactive powers during -1Hz/s event .....</b>	<b>41</b>
<b>Figure 78 Average frequency during +1Hz/s event .....</b>	<b>42</b>
<b>Figure 79 Average frequency during -1Hz/s event .....</b>	<b>42</b>
<b>Figure 80 SMA inverter output active and reactive powers during +1Hz/s event .....</b>	<b>42</b>
<b>Figure 81 SMA inverter output active and reactive powers during -1Hz/s event .....</b>	<b>42</b>
<b>Figure 82 Average frequency during +1Hz/s event .....</b>	<b>43</b>
<b>Figure 83 Average frequency during -1Hz/s event .....</b>	<b>43</b>
<b>Figure 84 SMA inverter output active and reactive powers during +1Hz/s event .....</b>	<b>43</b>
<b>Figure 85 SMA inverter output active and reactive powers during -1Hz/s event .....</b>	<b>43</b>
<b>Figure 86 Average frequency during +1Hz/s event .....</b>	<b>44</b>
<b>Figure 87 Average frequency during -1Hz/s event .....</b>	<b>44</b>
<b>Figure 88 ABB inverter output active and reactive powers during +1Hz/s event .....</b>	<b>44</b>
<b>Figure 89 ABB inverter output active and reactive powers during -1Hz/s event .....</b>	<b>44</b>
<b>Figure 90 SMA inverter output active and reactive powers during +1Hz/s event .....</b>	<b>45</b>
<b>Figure 91 SMA inverter output active and reactive powers during -1Hz/s event .....</b>	<b>45</b>
<b>Figure 92 Average frequency during +1Hz/s event .....</b>	<b>46</b>
<b>Figure 93 Average frequency during -1Hz/s event .....</b>	<b>46</b>
<b>Figure 94 ABB inverter output active and reactive powers during +1Hz/s event .....</b>	<b>46</b>
<b>Figure 95 ABB inverter output active and reactive powers during -1Hz/s event .....</b>	<b>46</b>
<b>Figure 96 Kaco inverter output active and reactive powers during +1Hz/s event .....</b>	<b>47</b>
<b>Figure 97 Kaco inverter output active and reactive powers during -1Hz/s event .....</b>	<b>47</b>
<b>Figure 98 Average frequency during +1Hz/s event .....</b>	<b>48</b>
<b>Figure 99 Average frequency during -1Hz/s event .....</b>	<b>48</b>
<b>Figure 100 Fronius inverter output active and reactive powers during +1Hz/s event .....</b>	<b>48</b>
<b>Figure 101 Fronius inverter output active and reactive powers during -1Hz/s event .....</b>	<b>48</b>

**Figure 102 Kaco inverter output active and reactive powers during +1Hz/s event .....49**

**Figure 103 Kaco inverter output active and reactive powers during -1Hz/s event .....49**

**Figure 104 Average frequency during +1Hz/s event .....50**

**Figure 105 Average frequency during -1Hz/s event .....50**

**Figure 106 Kaco inverter output active and reactive powers during +1Hz/s event .....50**

**Figure 107 Kaco inverter output active and reactive powers during -1Hz/s event .....50**

**Figure 108 SMA inverter output active and reactive powers during +1Hz/s event .....51**

**Figure 109 SMA inverter output active and reactive powers during -1Hz/s event .....51**

**Figure 110 ABB inverter output during event .....53**

**Figure 111 ABB inverter output close up of waveform showing voltage phase shift .....53**

**Figure 112 Kaco inverter output during event .....53**

**Figure 113 Kaco inverter output close up of waveform showing voltage phase shift .....53**

**Figure 114 Fronius inverter output during event .....54**

**Figure 115 Fronius inverter output close up of waveform showing voltage phase shift .....54**

**Figure 116 SMA inverter output during event .....54**

**Figure 117 SMA inverter output close up of waveform showing voltage phase shift .....54**

**Figure 118 SMA inverter output during event .....55**

**Figure 119 SMA inverter output close up of waveform showing voltage phase shift .....55**





## List of Tables

<b>Table 1 PV inverters under test .....</b>	<b>10</b>
<b>Table 2 Summary of test category 1 results .....</b>	<b>14</b>



## 1 INTRODUCTION

This report summarises the findings from the experimental evaluation of the performance of low voltage photovoltaic (PV) inverters during specific predefined disturbances. This work has been commissioned by the joint distribution code and grid code working group GC0079 on frequency changes during large disturbances and their effect on the total system.

A set of PV inverters were tested at the power networks demonstration centre (PNDC)<sup>1</sup>. Three main tests were conducted to reflect the scope of the working group as described in section 2. The results of these tests have been reported in section 3. The appendices depict graphs of the main measurements made during these tests. The raw measurement data has been made available to the working group in digital format.

---

<sup>1</sup> <http://pndc.co.uk/>



## 2 TEST SETUP

Three main tests have been conducted to evaluate the performance of the PV inverters during various disturbances applied to the physical PNDC network, these tests are:

- Sensitivity of PV inverters to islanding under closely matched generation/load conditions.
- Stability of PV inverters against a controlled grid rate of change of frequency event.
- Stability of PV inverters against a simultaneous frequency drop and voltage phase shift induced by a network fault.

This section summarises the PV inverters tested, their configuration, the test network configuration and tests applied.

### 2.1 PV inverters under test

Five inverters have been tested in this project as summarised in Table 1. These inverters have been chosen in consultation with the ENA working group and are representative of the present situation on the UK market according to information provided by the project partner Ecofys<sup>2</sup>.

**Table 1 PV inverters under test**

Phases	PV Inverter	Maximum AC Power Rating	Transformer less	Available Inverter Settings
Single Phase	ABB PVI-5000-TL-OUTD [1]	5.56kVA	Yes	G59/3 [2], G83/2 [3]
	SMA Sunny Boy 5000TL [4]	5kVA	Yes	G59/3, G83/2
	Kaco Powador 6002 [5]	5kVA	No	G59/2 [6], G83/1
	Fronius IG Plus 30 V-1 [7]	3kVA	No	G83/1 (pre- G83/2 model)
Three Phase	SMA Tripower 10000TL [8]	10kVA	Yes	G59/3, G83/2

### 2.2 PV emulators used to supply inverters under test

In order to supply the inverters under test, two calibrated 5kW programmable DC power supplies with PV array emulation have been used. These are the Chroma 62050H-600S [9]. Each PV emulator can supply one inverter at a time due to two main reasons:

- Some inverters require a minimum level of DC insulation before starting up. When more than one inverter is connected to a PV emulator output simultaneously, the current drawn by these inverters can be seen as a leakage current in the DC insulation which prevents them from starting up.

<sup>2</sup> This is with reference to the draft Ecofys (<http://www.ecofys.com/>) report for their respective project work package.

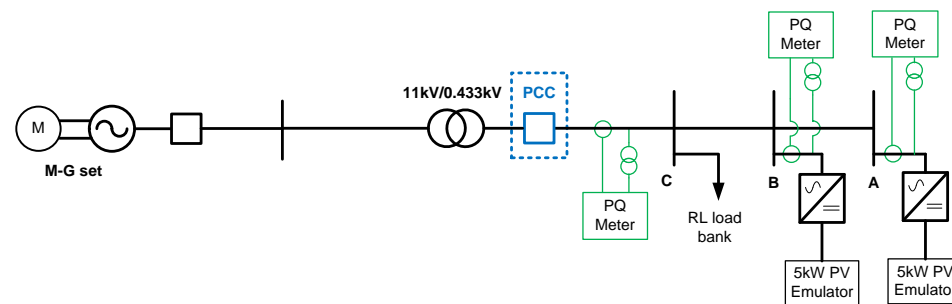
- If inverters connected simultaneously to the output of a PV emulator do start up, then the Maximum Power Point Tracking (MPPT) controllers of the inverters will cause contention for power drawn from the supply. This results in continuous power output oscillation of the connected inverters.

The PV emulators can be operated in different modes. However, for the purposes of testing a target power output and maximum DC voltage were set. The PV emulator would then use the built-in EN50530 model to calculate the required current output to enable maximum power point tracking (MPPT) for the inverter [10]. This is deemed sufficient for creating the initial conditions for each test.

### 2.3 Test Category 1: PV inverter sensitivity to islanding

**Test objective:** to determine whether the inverters under test can detect an island and trip when the output power of the inverter and amount of local load are closely matched prior to islanding.

The PNDC network configuration for this test is shown in Figure 1.



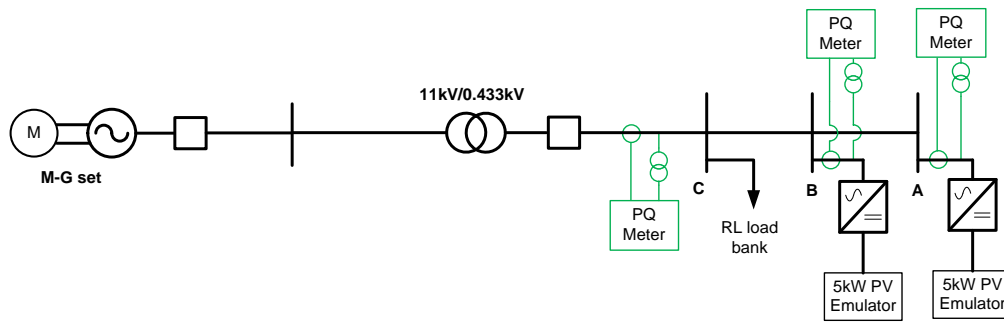
**Figure 1 Network configuration for islanding tests**

In this test, up to two inverters are connected to the LV network. The power output of the inverters and amount of load consumed were set up such that the power flow through the point of common coupling (PCC) is as close to zero as possible. Achieving zero power exchange across the point of common coupling is not possible as it was found out that the inverters always export a minimum amount of reactive power when connected to the grid. This is despite the inverters' default mode of control is to operate the inverters at unity power factor. Furthermore, there are natural variations in the loading conditions caused by continuous loading overtime, capacitance of LV cable circuits, tolerances of the circuits used during testing and the minimum controllable power steps of the load banks. The island is created by opening the PCC. Calibrated Fluke 435-II power quality analysers were used to measure voltage, current and power at the terminals of the inverters as well as at the PCC [11].

### 2.4 Test Category 2: PV inverter stability against rate of change of frequency disturbances

**Test objective:** to determine whether the inverters remain synchronised to the grid during a rate of change of frequency event of up to 1Hz/s.

The PNDC network configuration for this test is shown in Figure 2.



**Figure 2 Network configuration for RoCoF disturbances**

In this test, the motor-generator (M-G) set is used to vary the frequency of the test network at a controlled rate, while observing the output and protection alarms of the inverters. The RoCoF events performed are:

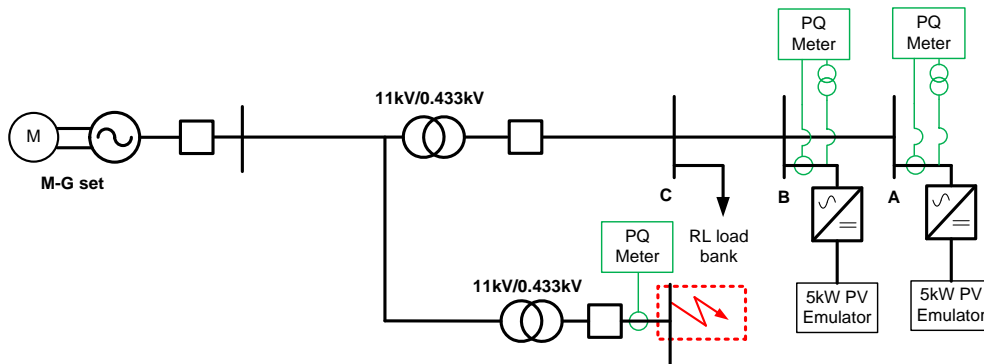
- Accelerate the M-G set at a rate of 1Hz/s between 48Hz – 50Hz.
- Decelerate the M-G set at a rate of 1Hz/s between 51Hz – 49Hz.

The frequency bands (i.e. 48-50Hz and 51-49Hz) were chosen to avoid triggering of the network or inverters' under and over frequency protection.

### 2.5 Test Category 3: PV inverter stability against simultaneous frequency and voltage disturbances

**Test objective:** to determine whether the inverters remain synchronised to the grid during a simultaneous rate of change of frequency and voltage phase shift.

The PNDC network configuration for this test is shown in Figure 3.



**Figure 3 Network configuration for simultaneous frequency and voltage phase disturbances**

The rate of change of frequency disturbance is achieved through the controlled deceleration of the M-G set at an initial rate of 0.5Hz/s from 50Hz to 49Hz, while the voltage phase shift is achieved by applying a phase to phase fault on the LV network after 0.5s of issuing the M-G set deceleration command.

### 3 TESTING RESULTS

This section summarises the main findings from the three testing categories. All graphs of associated measurements are presented in the Appendices A, B and C of this report and will be referred to in the relevant test category section. The recorded data used to generate these graphs has been supplied to the working group.

The time axes in all graphs represent the recording time of each individual PQ analyser. These however are not synchronised together. The starting points of the events can be determined from distinct changes in the graph voltage and current. The active and reactive power flows depicted are 0.25s averages recorded by the Fluke power quality analyser.

#### 3.1 Test Category 1

Table 2 summarises the initial conditions prior to islanding and average inverter disconnection times post islanding. The average is calculated from the number of measurement points (i.e. two for a single inverter and three for two inverters). Appendix A contains graphs of instantaneous voltage and current and 0.25s average active and reactive power flows.

The average inverter disconnection time is calculated from the voltage and current waveforms measured at the inverter output and at the PCC.

The adopted power flow convention direction is as follows:

- Inverter output power export: positive for active power and negative reactive power.
- PCC: positive for active and reactive power flows towards the load.

It is clear from the test results that all inverters detected the loss of mains event and disconnected from the grid successfully. The longest loss of mains tripping time is 0.9s and is associated with the Kaco inverter. The shortest inverter disconnection time is associated with the SMA inverters and is around 0.12s.



**Table 2 Summary of test category 1 results**

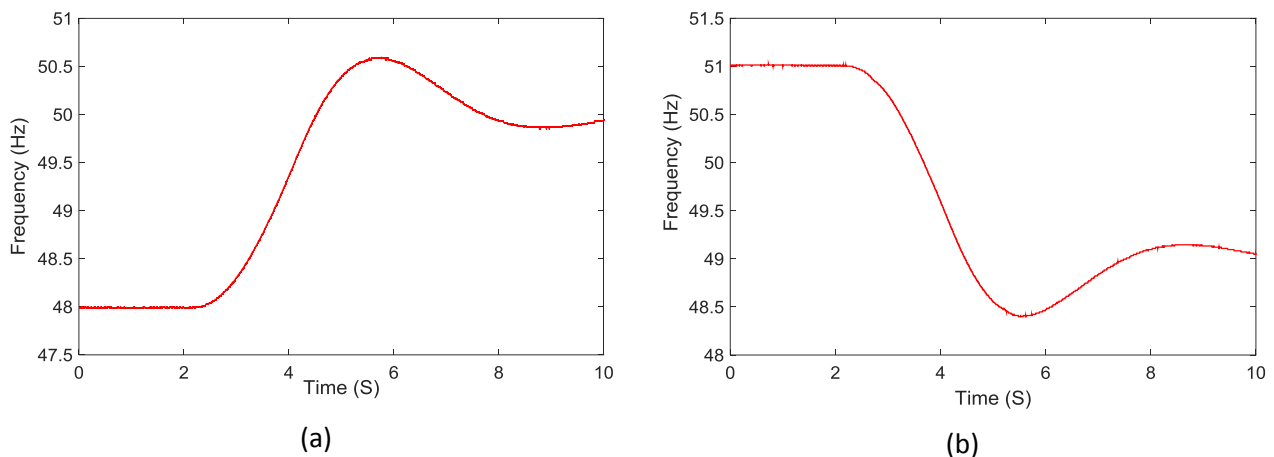
Inverter 1	Inverter 2	Inverter 1 steady state power output		Inverter 2 steady state power output		PCC power flow prior to islanding		Average inverter disconnection time (s)
		Active Power (W)	Reactive Power (VAr)	Active Power (W)	Reactive Power (VAr)	Active Power (W)	Reactive Power (VAr)	
ABB		3000	-30			-10	-10	0.406
Kaco		3100	-50			20	10	0.9
Fronius		2030	-15			-2	143	0.275
SMA (1 phase)		3110	-40			0	-10	0.123
SMA (3 phase)		2970	-150			-40	40	0.126
ABB	SMA (1 phase)	3050	-30	3060	-50	0	-50	0.324
ABB	Kaco	3050	-30	3000	-60	0	20	0.493
Fronius	Kaco	2210	120	2910	-20	0	-160	0.465
Kaco	SMA (1 phase)	3050	-30	3070	-50	-10	30	0.458

### 3.2 Test Category 2

Graphs of 0.25s average network frequency and active and reactive power flows for this test category are depicted in Appendix B.

Inverters were tested individually and in groups similar to test category 1 (refer to Table 2).

Figure 4 (a) and (b) shows typical frequency profiles achieved during this test category. The frequency profile is derived from the MG-set speed which is fed back to the RTDS which is controlling the machine's speed.



**Figure 4 Typical frequency profiles during test category 2 (a) 1Hz/s ramp up and (b) 1Hz/s ramp down**

#### 3.2.1 Verification of applied RoCoF disturbance

In order to verify that the obtained rate of change of frequency during the test is indeed the desired 1Hz/s (accelerating and decelerating), a sample of measured instantaneous voltage was injected into a commercial loss of mains relay (an Alstom P341 generator interconnection relay) using an Omicron CMC356 test set. The RoCoF protection setting of the relay was increased gradually until the relay stopped tripping for the injected waveform. In this case, the RoCoF measured by the relay is between 1.3-1.4Hz/s.

#### 3.2.2 Discussion of test findings

All inverters remained stable during both accelerating and decelerating RoCoF events with the following notable observations:

- The ABB inverter experienced a reduced power output during the event which is discussed further in section 3.2.3.
- All transformer-less inverters (SMA and ABB) have experienced a momentary change in reactive power output during these events of up to around 1.5kVA per phase. A positive grid RoCoF results in reactive power import by the inverters, while additional reactive power is exported during a negative grid RoCoF. The duration and extent of change depends on the inverter and severity of the RoCoF event. No significant change in reactive power was recorded for the Kaco or Fronius inverters during these events.
- It is noted that the Fronius inverter trips in one of the positive RoCoF events. This is due to the grid frequency breaching the inverter's over frequency protection limit of 50.5Hz, rather than a spurious loss of mains protection operation. This over frequency protection trip setting is specified in G83/1 which was the active setting of the Fronius inverter during testing (which is a pre G83/2 model).





### 3.2.3 ABB inverter active power output drop during RoCoF events

It was observed during this test category that the active power output of the ABB inverter was momentarily reduced. In order to establish the extent of RoCoF event necessary to cause this reduction in power output, the inverter was subjected to different levels of RoCoF at increments of 0.1Hz/s with varying frequency change bands.

According to the obtained measurements, the inverter begins to reduce its power output when the RoCoF value is around 0.7Hz/s with a frequency change band of at least 1.5Hz. This results in a 64% drop in active power output compared to pre event active power output. The reduction in power output lasts for around 1s.

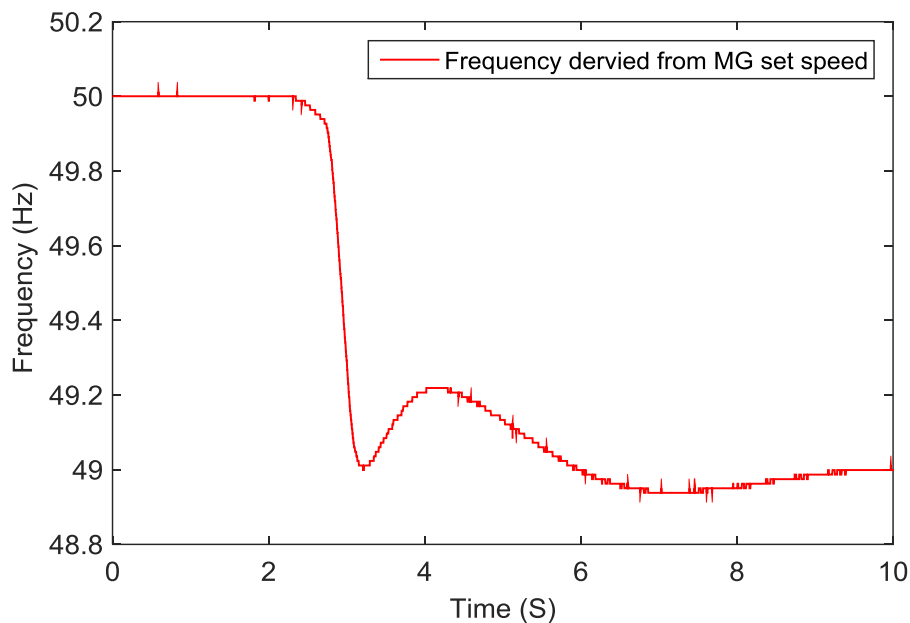
The active power output of the inverter is reduced to zero for about 1s at RoCoF values of 0.8Hz/s and over.

### 3.3 Test Category 3

Graphs of instantaneous voltage and current waveforms measured at the output of the inverters are depicted in Appendix C. The same graphs are also shown with a close up to the distorted waveforms during the initial voltage phase shift. It is difficult to discern the amount of voltage phase shift from the waveforms, therefore secondary injection was used to verify this as described in section 3.3.1.

Single phase inverters were tested in pairs (ABB and Kaco, SMA and Fronius), while three phase SMA inverter was tested separately.

Figure 5 shows a typical frequency profile achieved during this test category. The frequency profile is derived from the MG-set speed which is fed back to the RTDS which is controlling the machine's speed.



**Figure 5 Typical frequency profile during test category 3**

#### 3.3.1 Verification of applied voltage phase shift

Similar to test category 3, secondary injection of the Alstom P341 relay has been used to verify the obtained voltage vector shift during the test. In this case the vector shift measured by the relay is between 6-7°. Although the initial RoCoF during this test is 0.5Hz/s, it has increased after an introduction of the phase-phase fault. The relay measures between 5-6Hz/s.

#### 3.3.2 Discussion of test findings

All inverters remained stable during this test. However, the ABB inverter has also shown a drop in active power export due to the severe RoCoF experienced during this test. The active power output did not drop to zero due to the frequency change being limited to around 1Hz.



## 4 CONCLUSIONS

A number of tests have been carried out to assess the behaviour of PV inverters during emulated grid events. These tests were designed to determine the ability of the inverters to successfully detect islanding and their stability against grid frequency and voltage phase shift disturbances.

All inverters under test were able to successfully detect the islanding conditions and trip in less than a second from island initiation.

The inverters were also stable to rate of change of frequency events of 1Hz/s and grid voltage vector shift of  $5.5^\circ$ , although one of the inverters reduced its active power output momentarily during these events. All transformer-less inverters have shown a momentary change in reactive power during the RoCoF test events. Due to the black box nature of these tests, the cause of these changes is unknown but is most likely due to the controls of the inverters. Furthermore, given the foreseen RoCoF targets planned during the future operation of the UK National Grid, such changes may not regularly manifest themselves if at all.



## 5 REFERENCES

- [1] ABB. *PVI-5000-TL-OUTD Single Phase Inverter*. Available: <http://goo.gl/9A4BF5>
- [2] Energy Networks Association, "Engineering Recommendation G59, Issue 3: Recommendations for the Connection of Generating Plant to the Distribution Systems of Licensed Distribution Network Operators," 2013.
- [3] Energy Networks Association, "ER G83/2: Recommendations for the Connection of Type Tested Small-scale Embedded Generators (Up to 16A per Phase) in Parallel with Low-Voltage Distribution Systems," 2012.
- [4] SMA. *Sunny Boy 5000TL Single Phase Inverter*. Available: <http://goo.gl/Zgx2IP>
- [5] Kaco Energy. *Powador 6002 Single Phase Inverter*. Available: <http://goo.gl/vk7lgy>
- [6] Energy Networks Association, "ER G59/2: Recommendations for the Connection of Generating Plant to the Distribution Systems of Licensed Distribution Network Operators," 2010.
- [7] Fronius. *Fronius IG Plus 30 V-1 Single Phase Inverter*. Available: <http://goo.gl/GHcK7r>
- [8] SMA. *Sunny Tripower 10000TL Three Phase Inverter*. Available: <http://goo.gl/tblcfk>
- [9] Chroma, "Programmable DC Power Supply (with SOlar Array Simulation) - 62000H Series Operating and Programming Manual," 2011.
- [10] British Standards International, "BS EN 50530:2010+A1:2013 Overall Efficiency of Grid Connected Photovoltaic Inverters," ed, 2013.
- [11] Fluke. *Fluke 435-II Power Qaulity and Energy Analyser*. Available: <http://goo.gl/gsuyiz>

## Appendix A – Graphs of category 1 test measurements

ABB inverter only connected

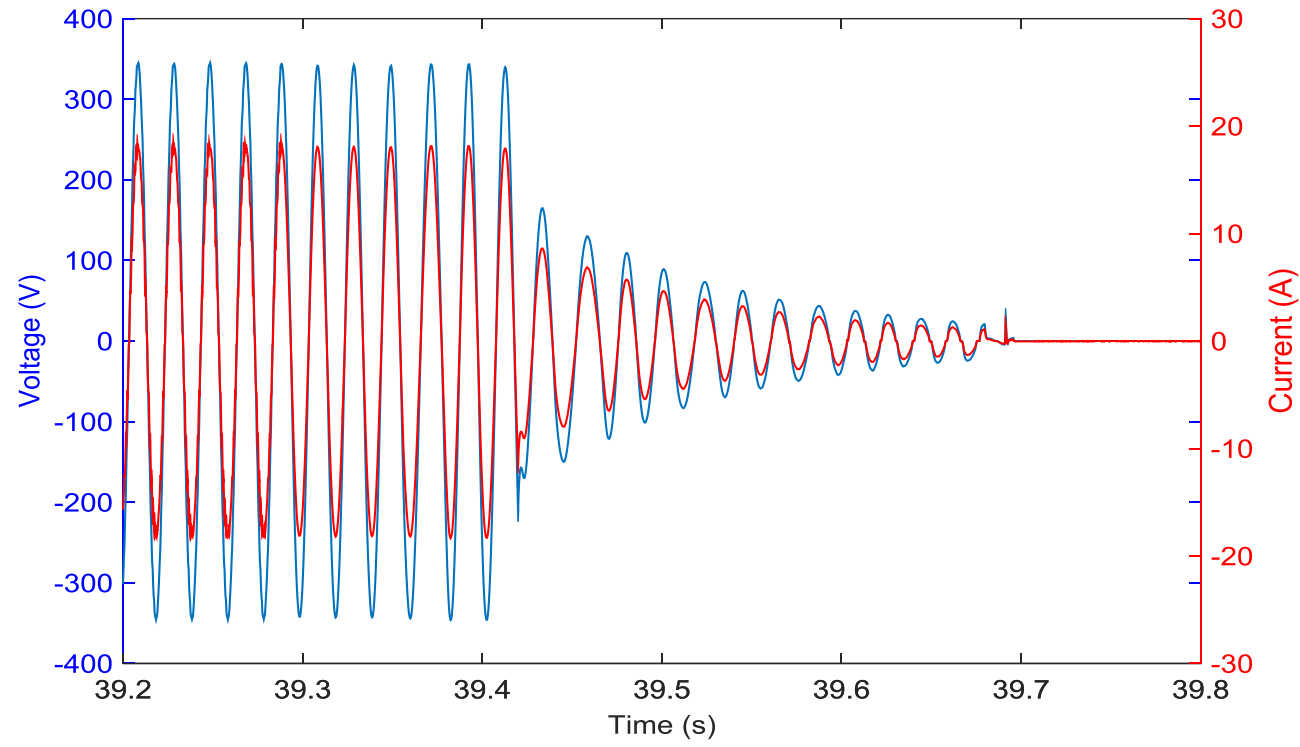


Figure 6 ABB inverter output current and voltage

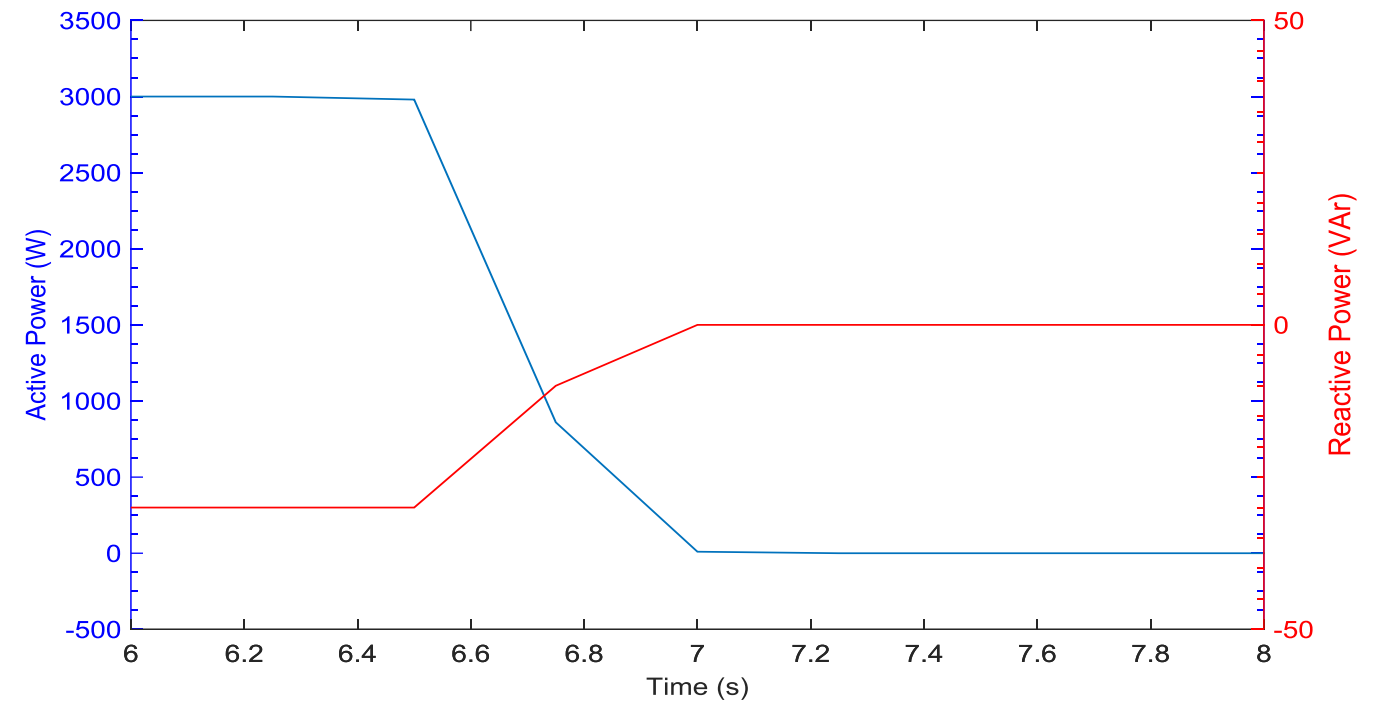


Figure 7 ABB inverter output active and reactive powers

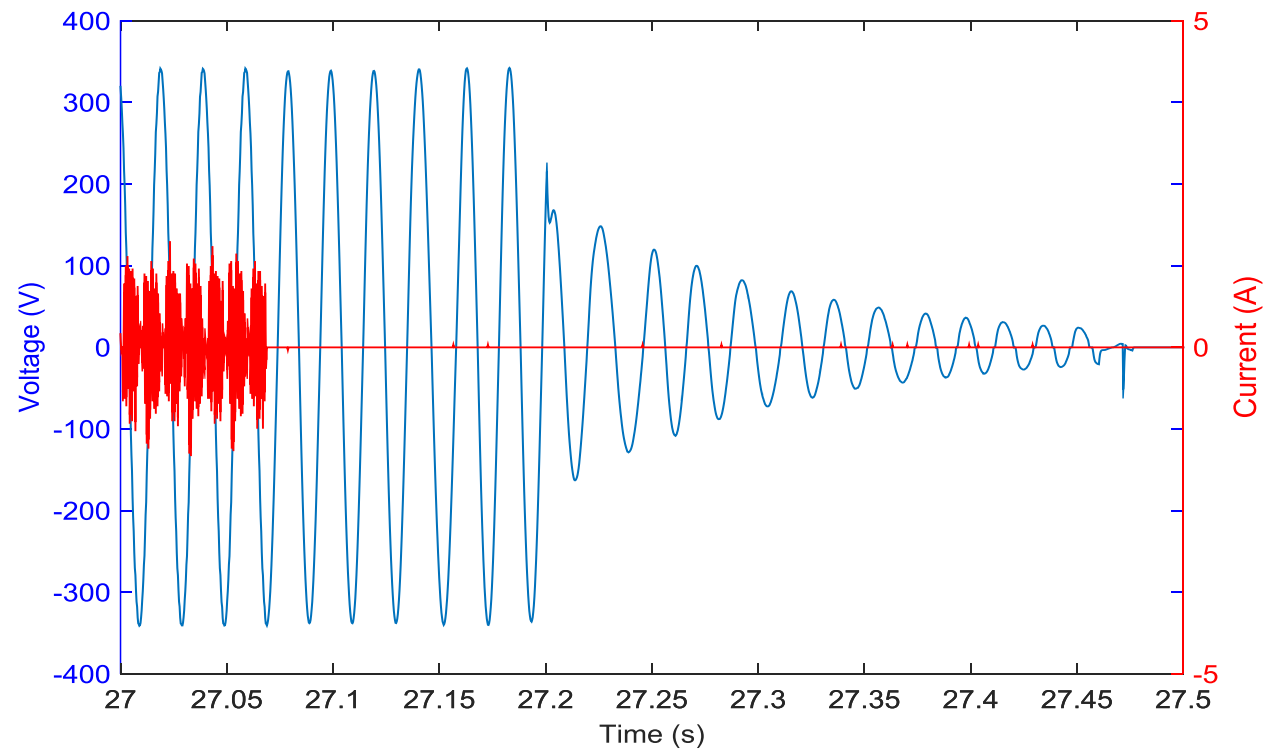


Figure 8 PCC current and voltage

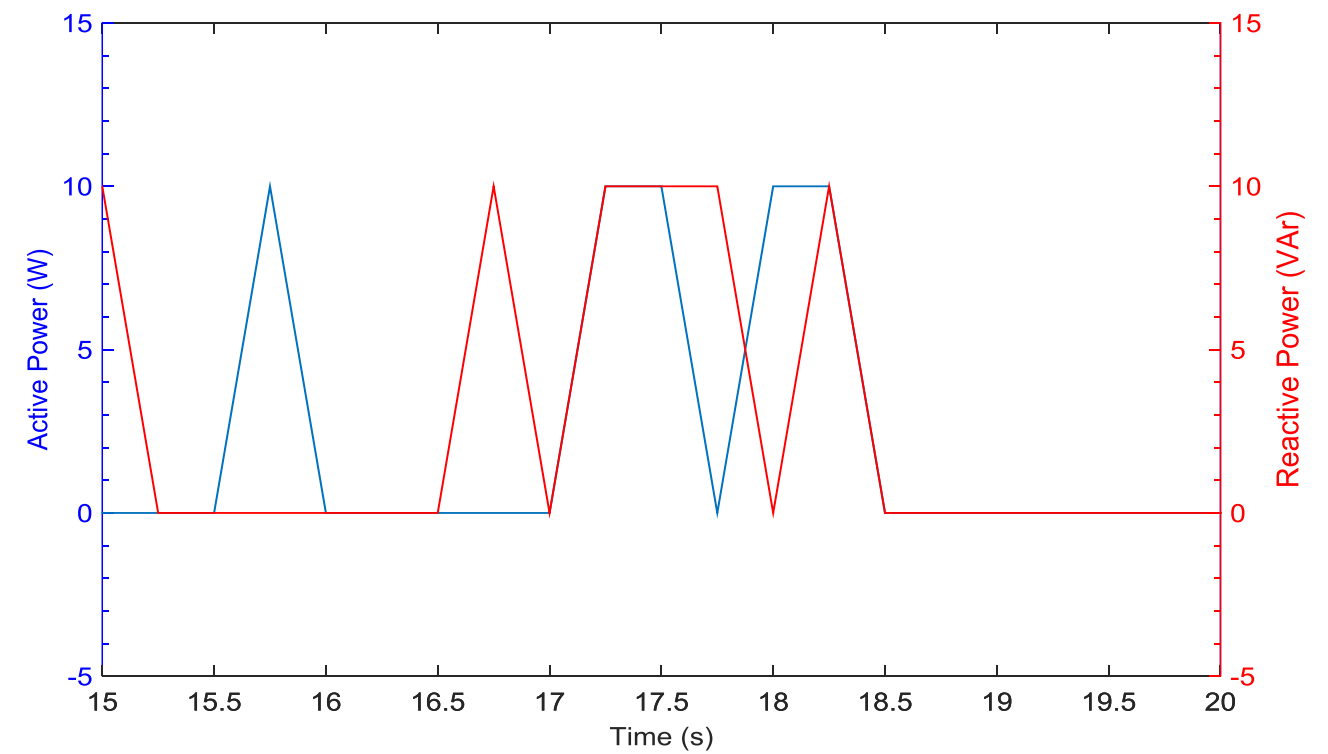


Figure 9 PCC active and reactive power flow

Kaco inverter only connected

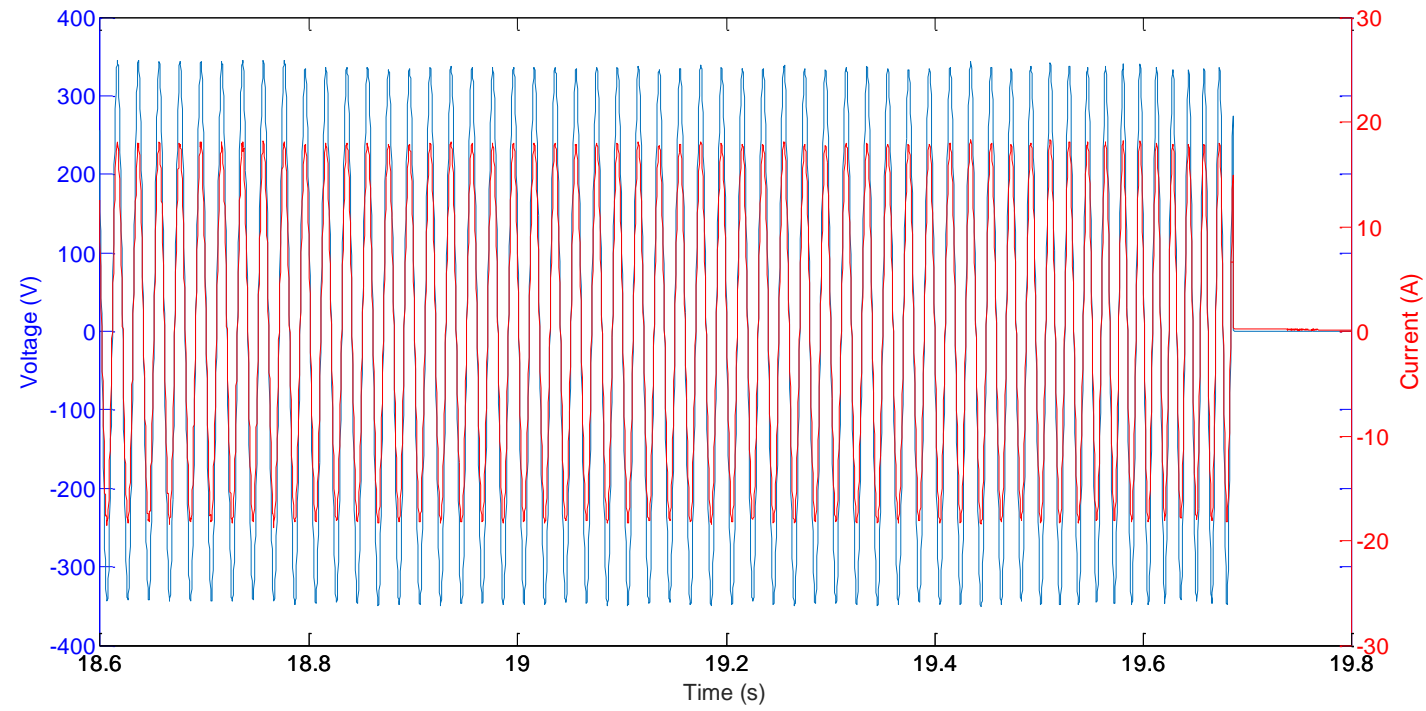


Figure 10 Kaco inverter output current and voltage

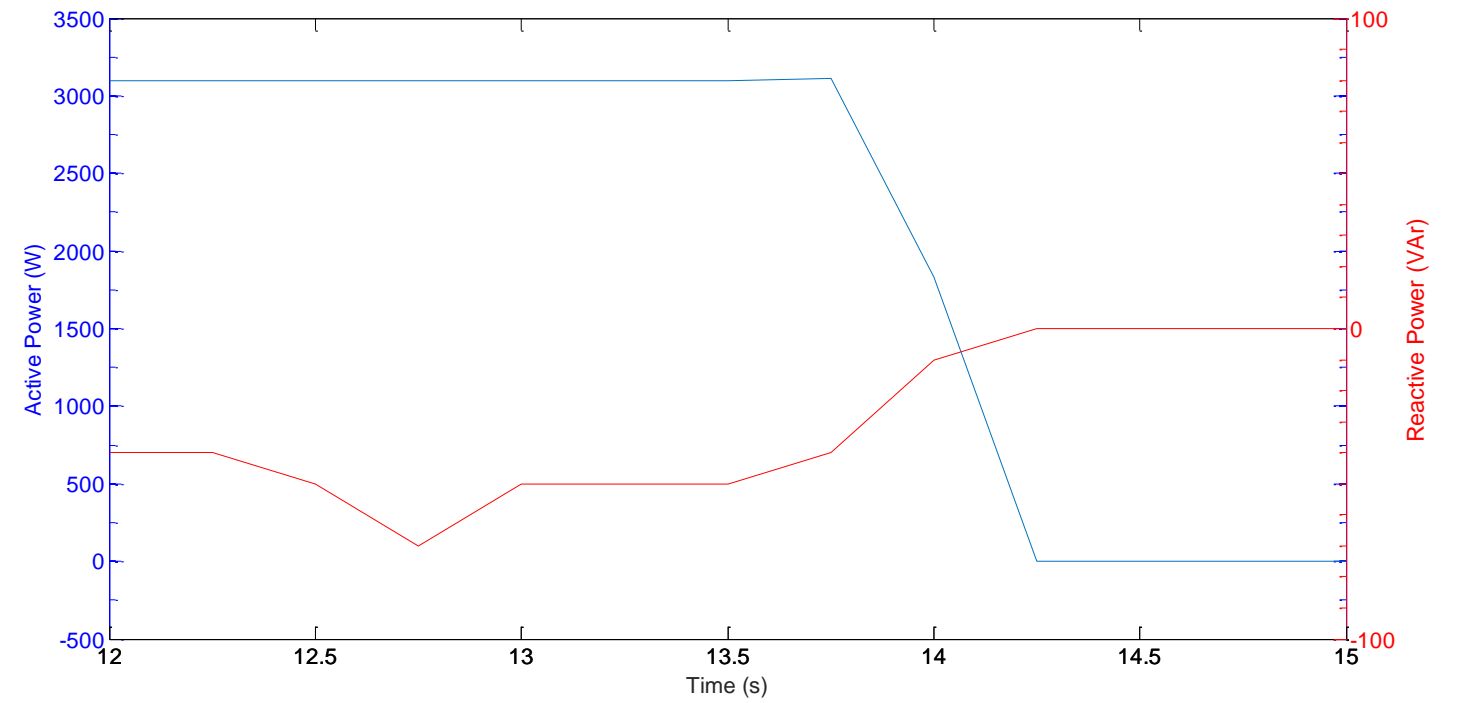


Figure 11 Kaco inverter output active and reactive powers

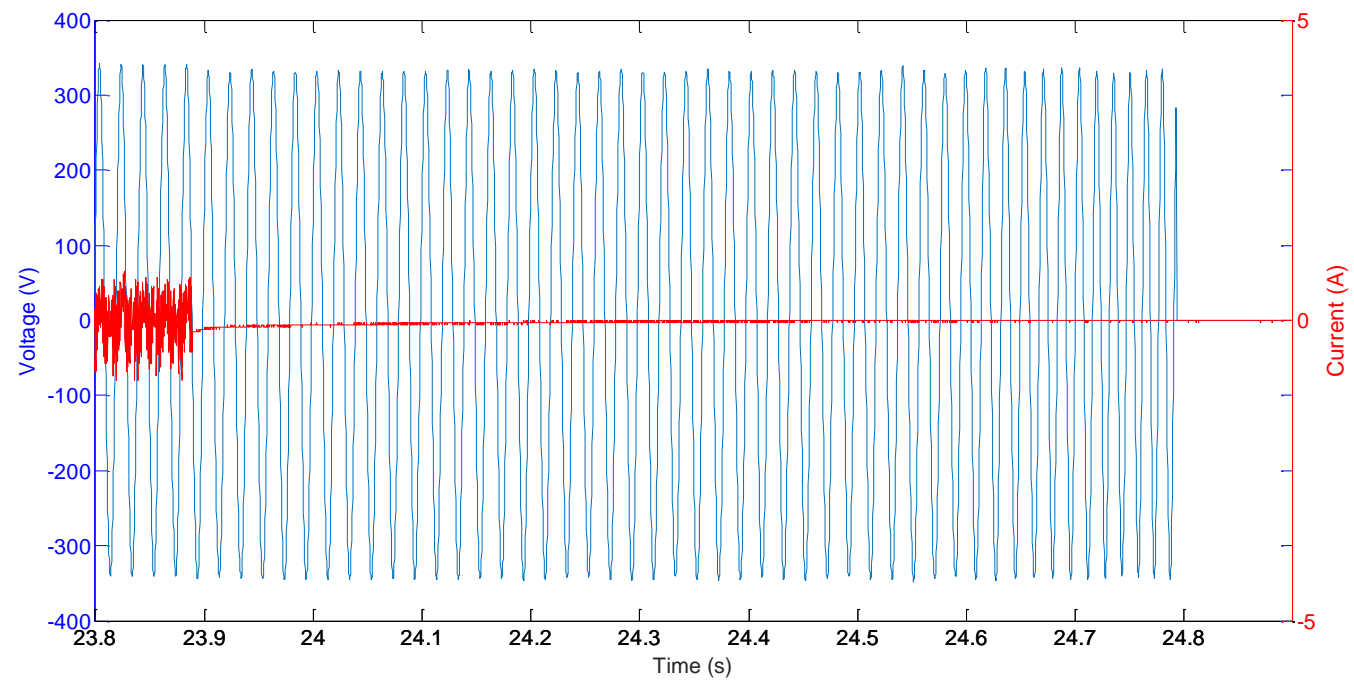


Figure 12 PCC current and voltage

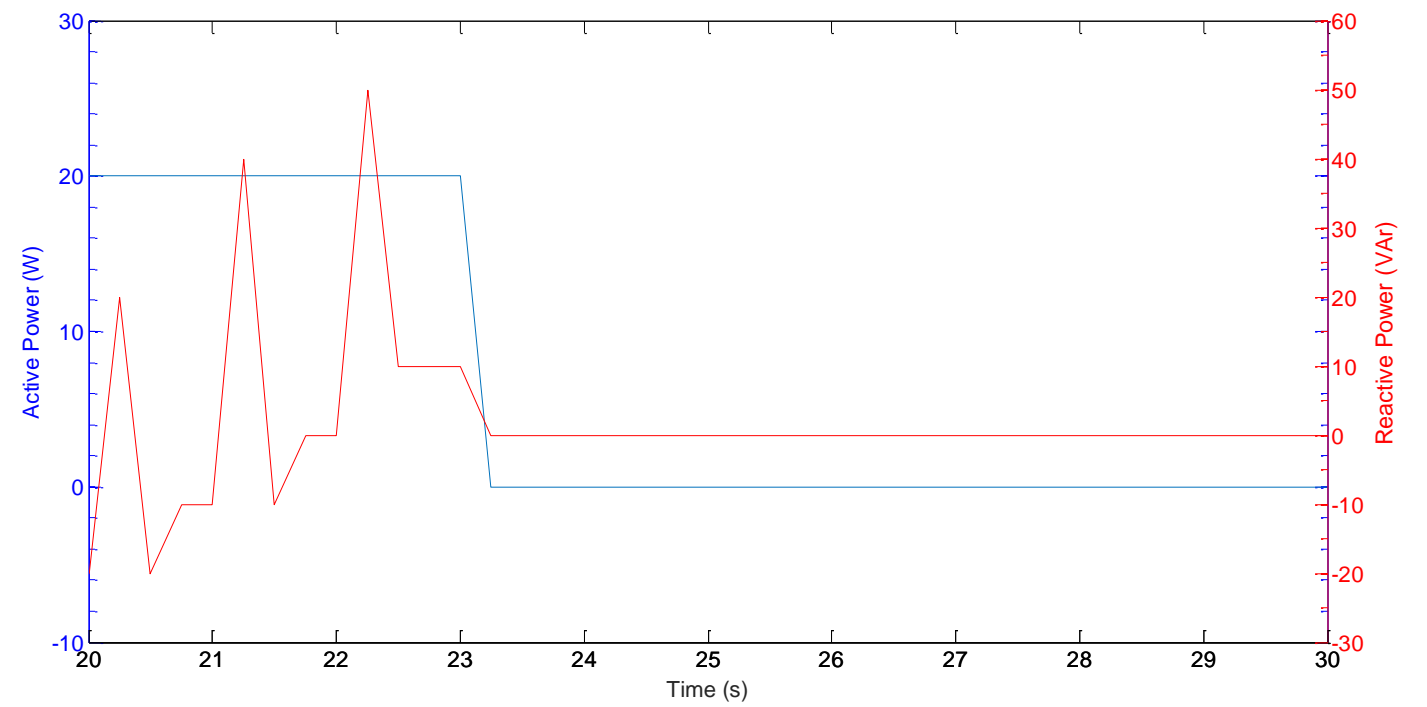


Figure 13 PCC active and reactive power flow

Fronius inverter only connected

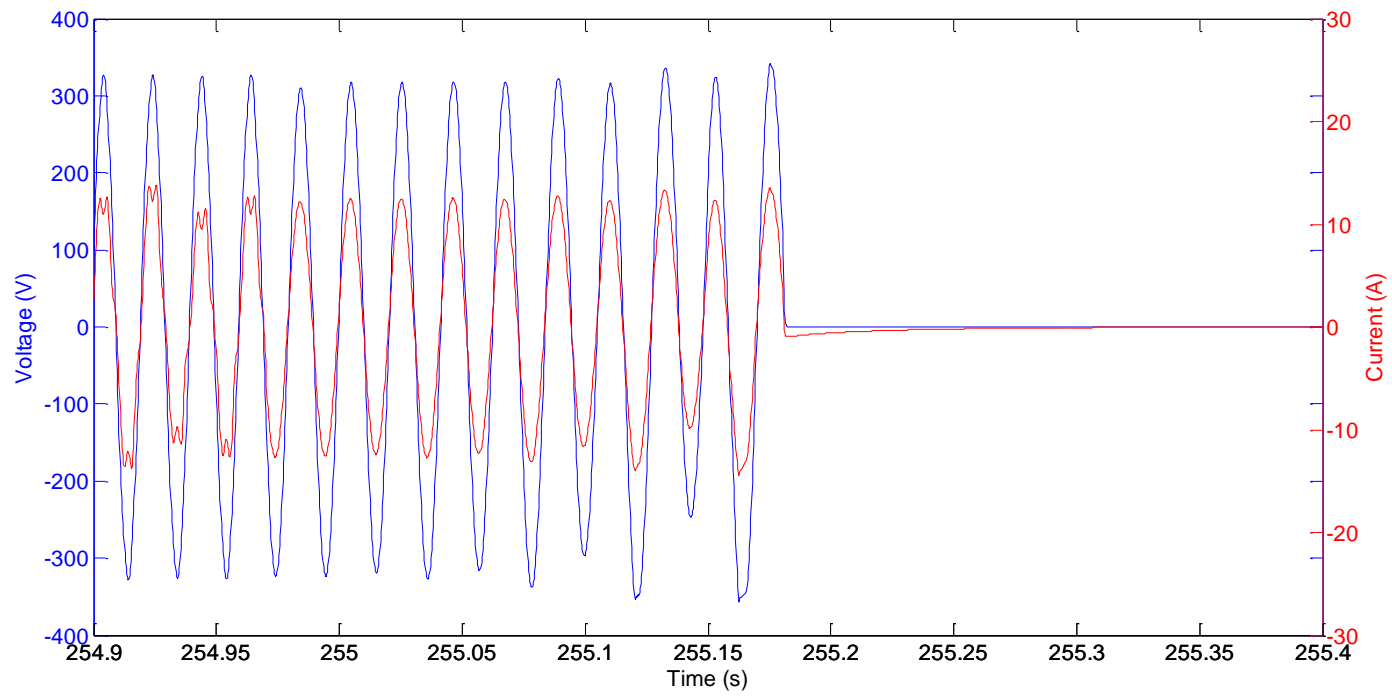


Figure 14 Fronius inverter output current and voltage

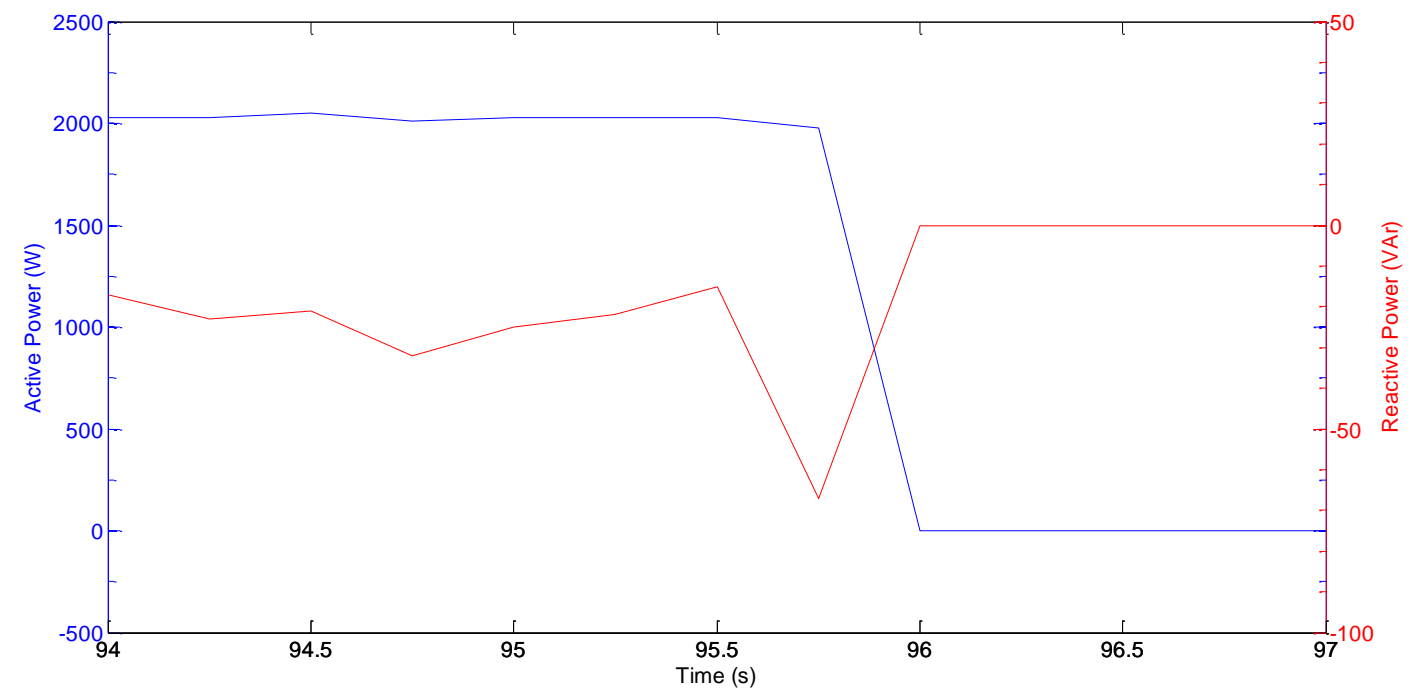


Figure 15 Fronius inverter output active and reactive powers

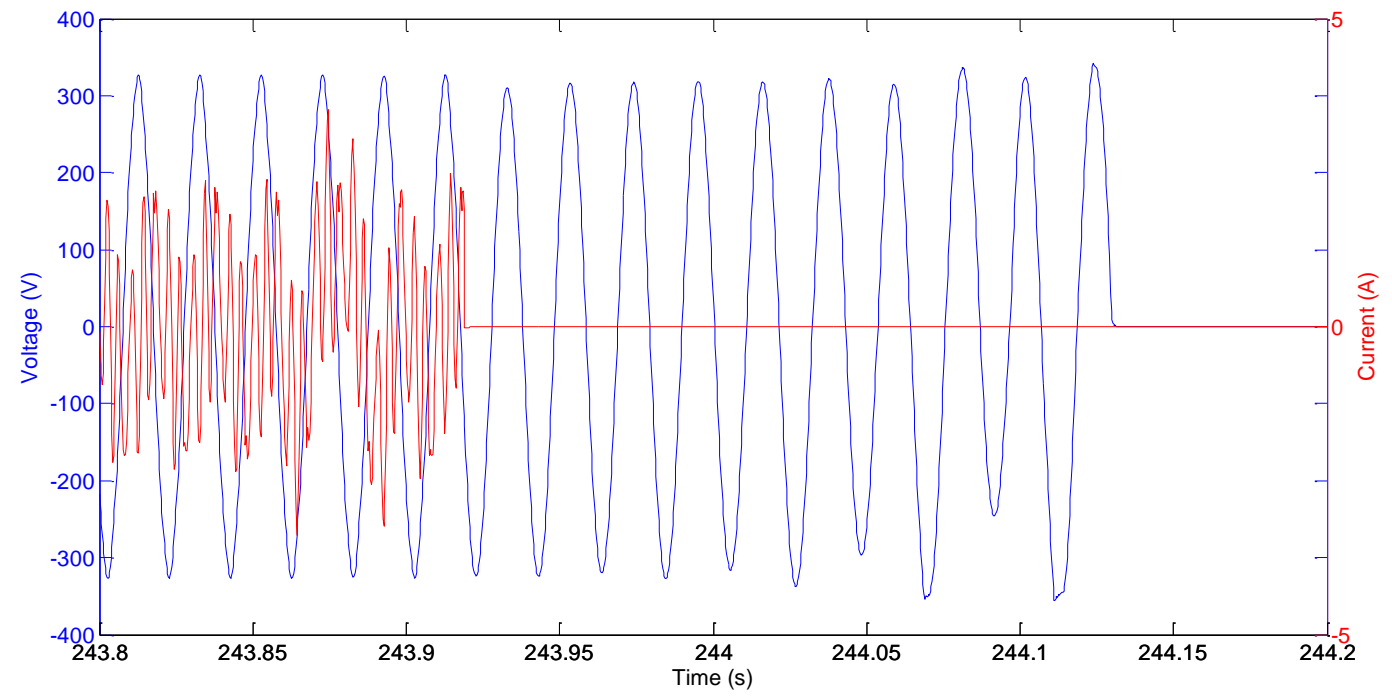


Figure 16 PCC current and voltage

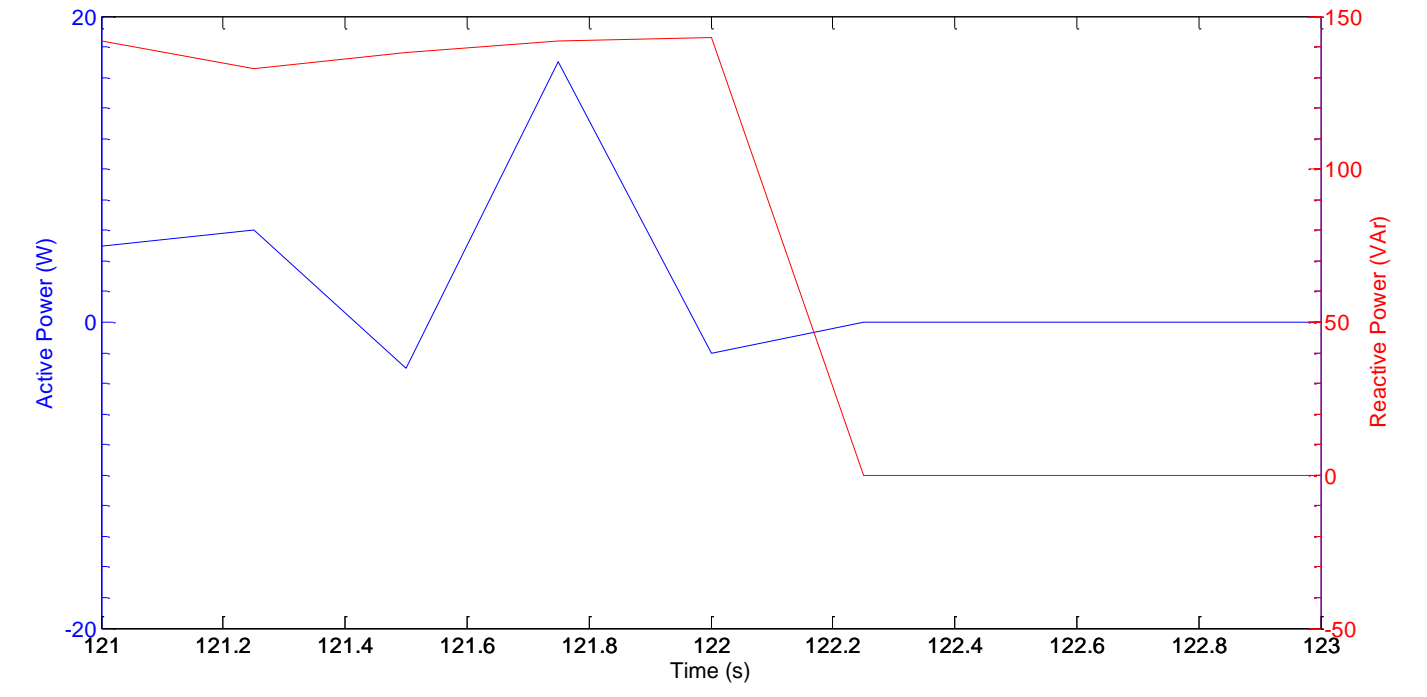


Figure 17 PCC active and reactive power flow



SMA single phase inverter only connected

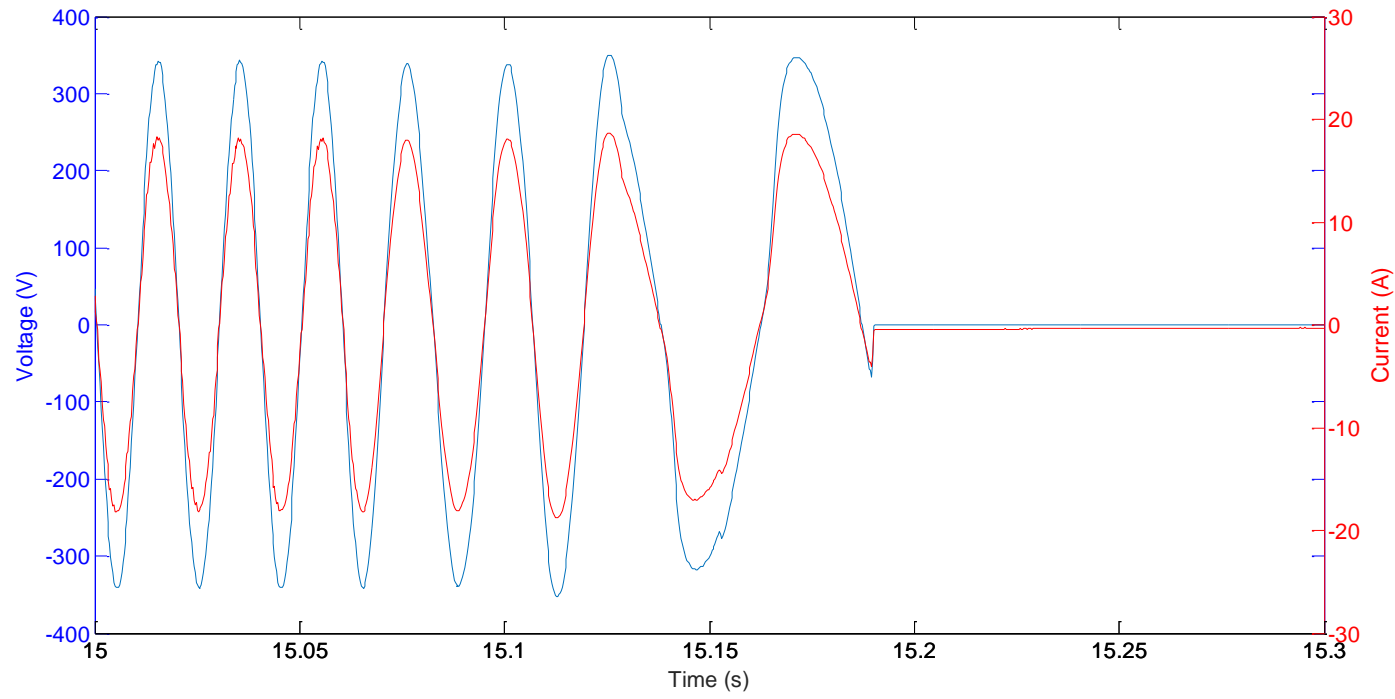


Figure 18 SMA inverter output current and voltage

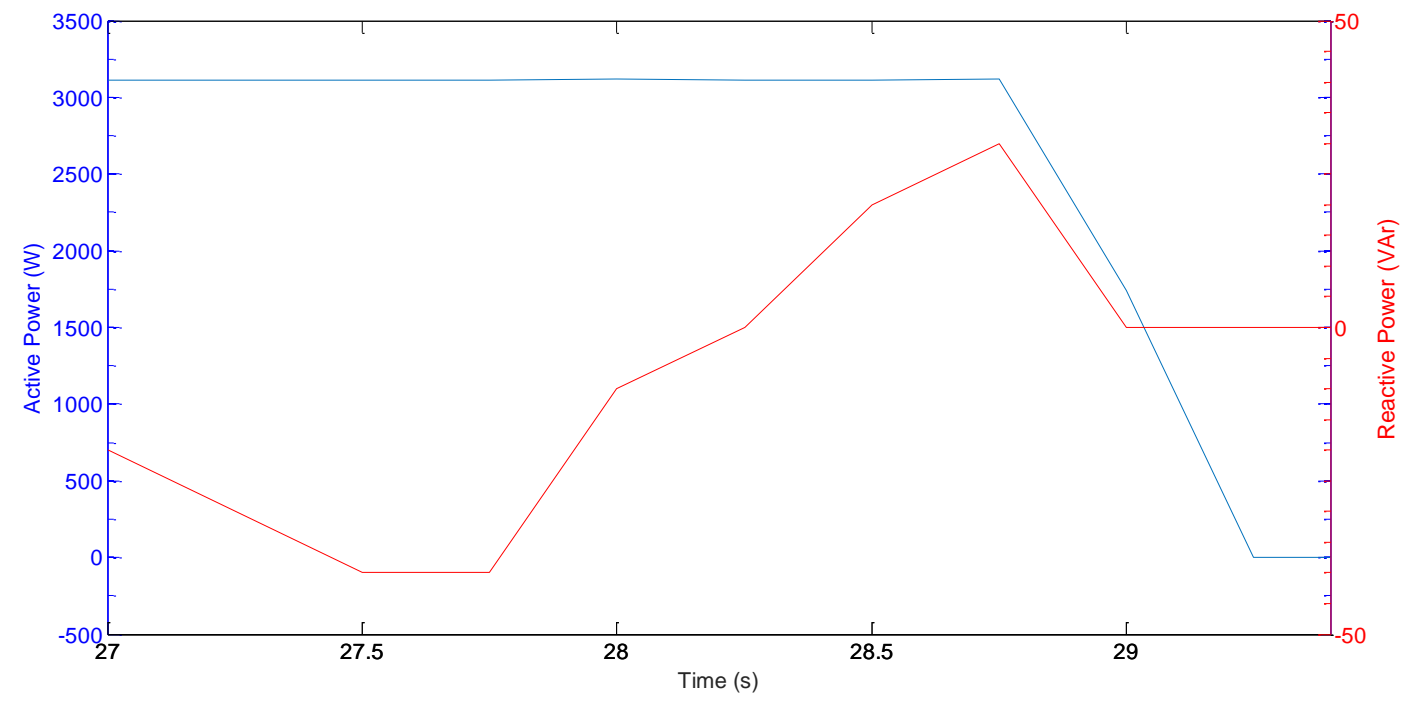


Figure 19 SMA inverter output active and reactive powers

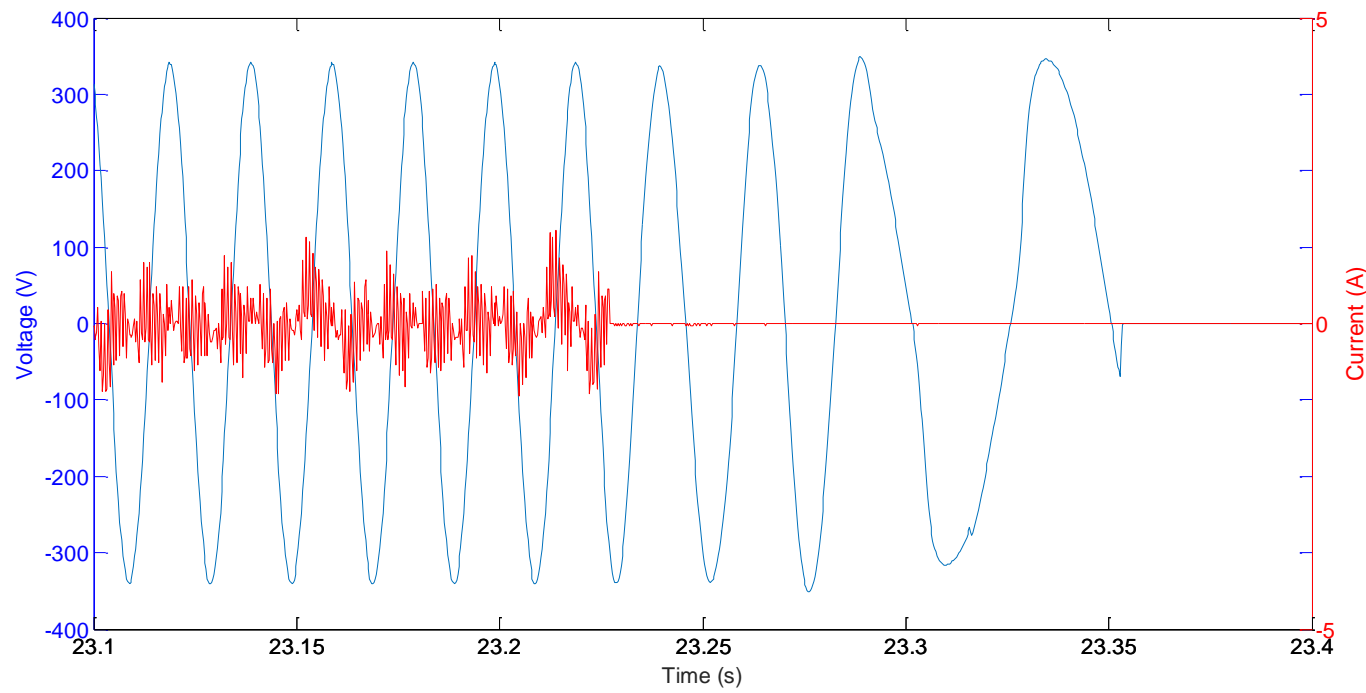


Figure 20 PCC current and voltage

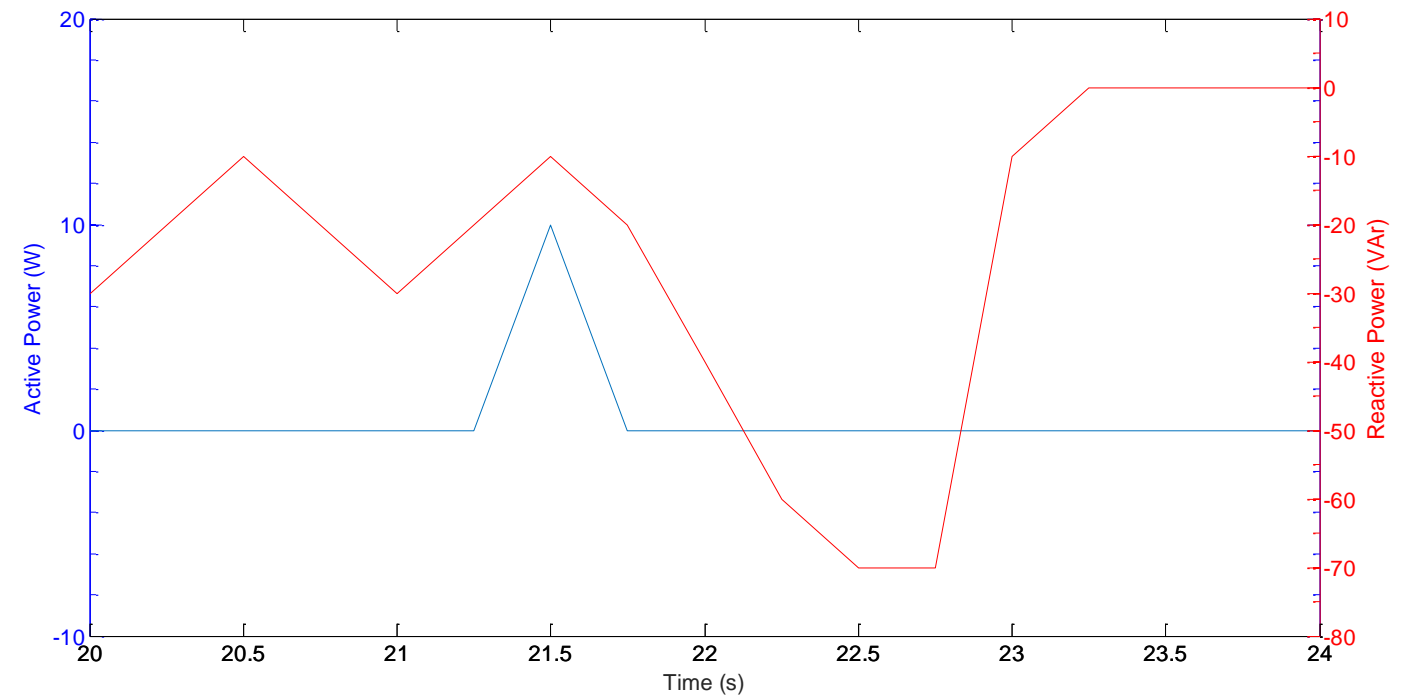


Figure 21 PCC active and reactive power flow

SMA three phase inverter only connected

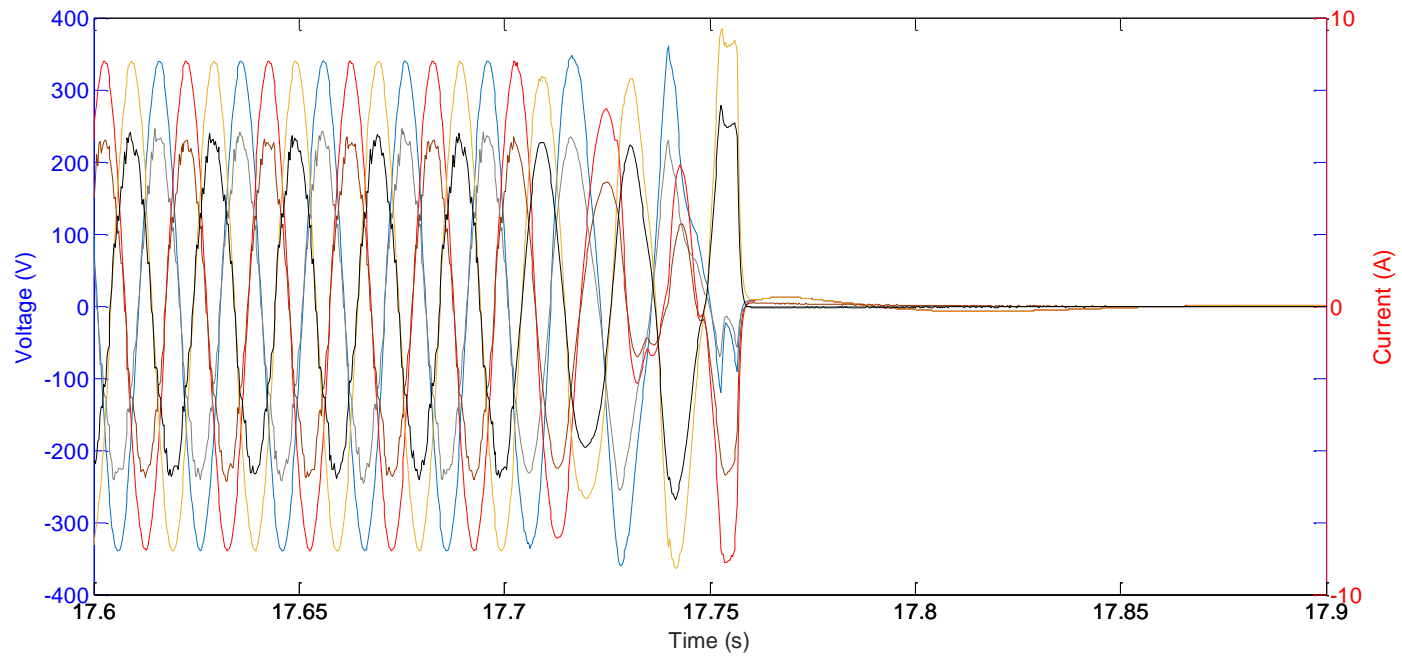


Figure 22 Three phase SMA inverter output current and voltage

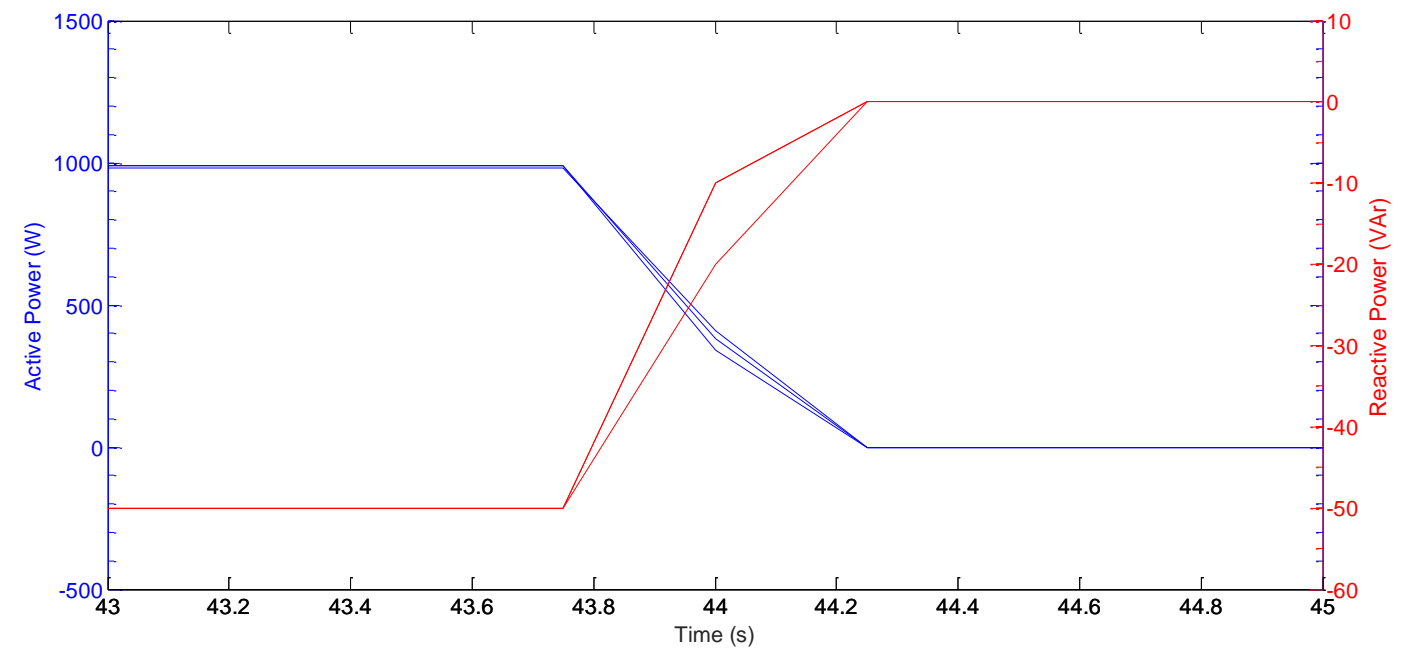


Figure 23 Three phase SMA inverter output active and reactive powers

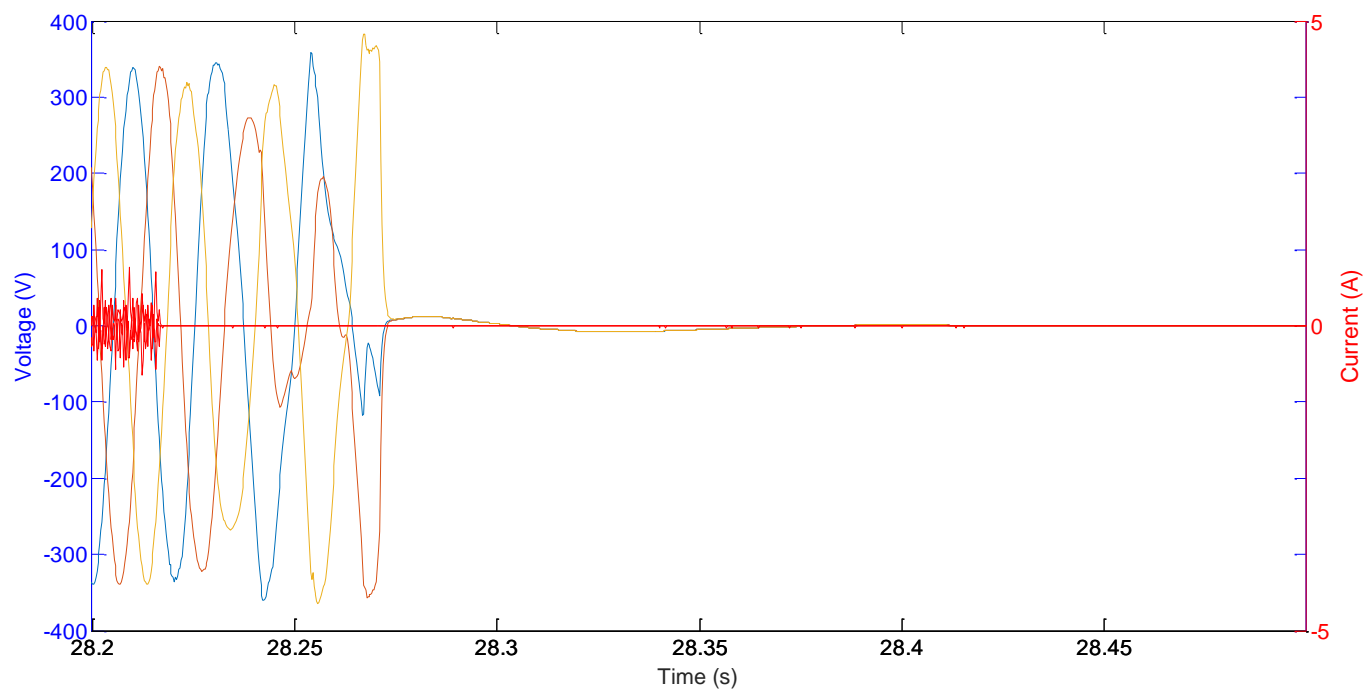


Figure 24 PCC current and voltage

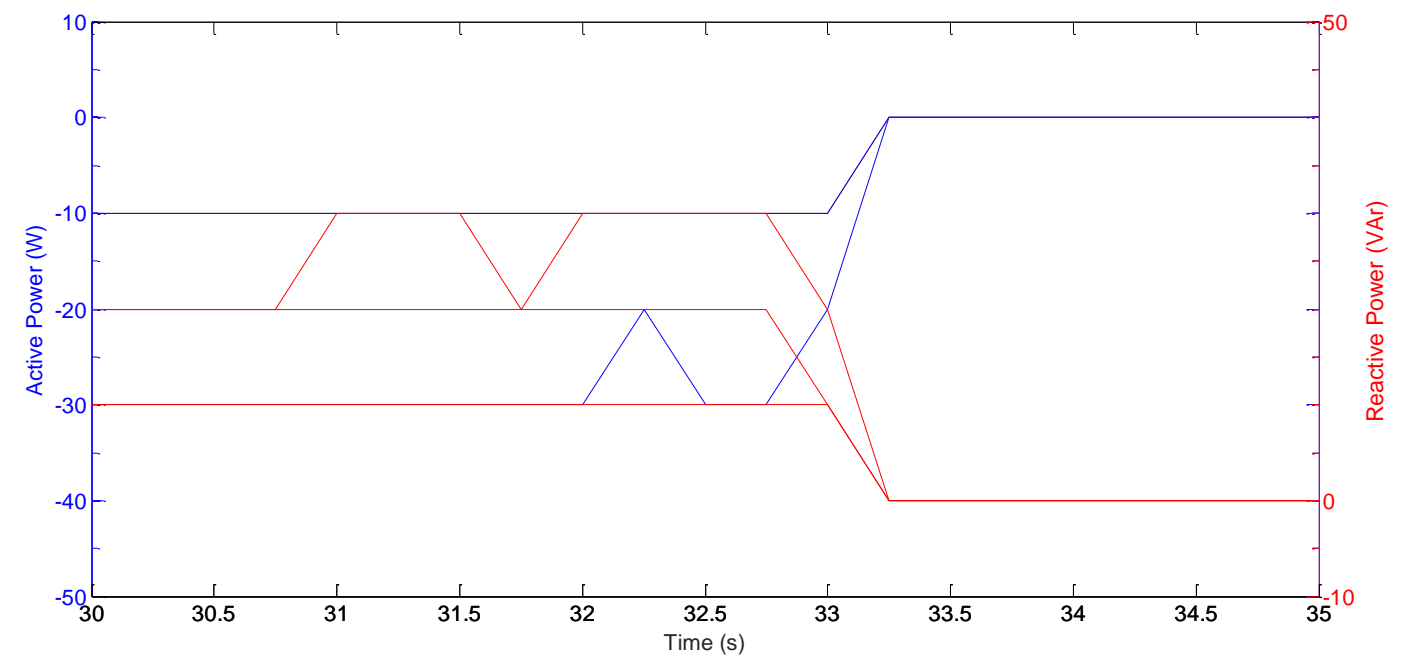


Figure 25 PCC active and reactive power flow

ABB and SMA inverters connected simultaneously

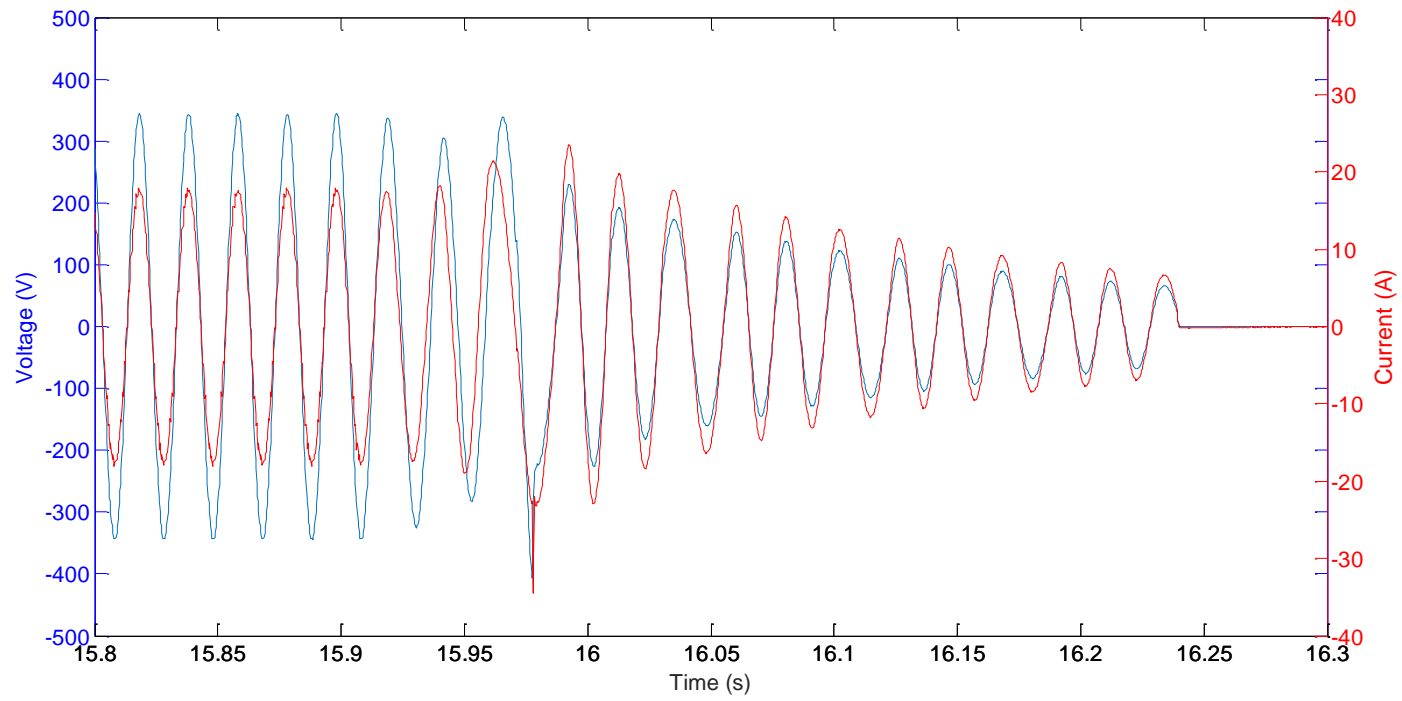


Figure 26 ABB inverter output current and voltage

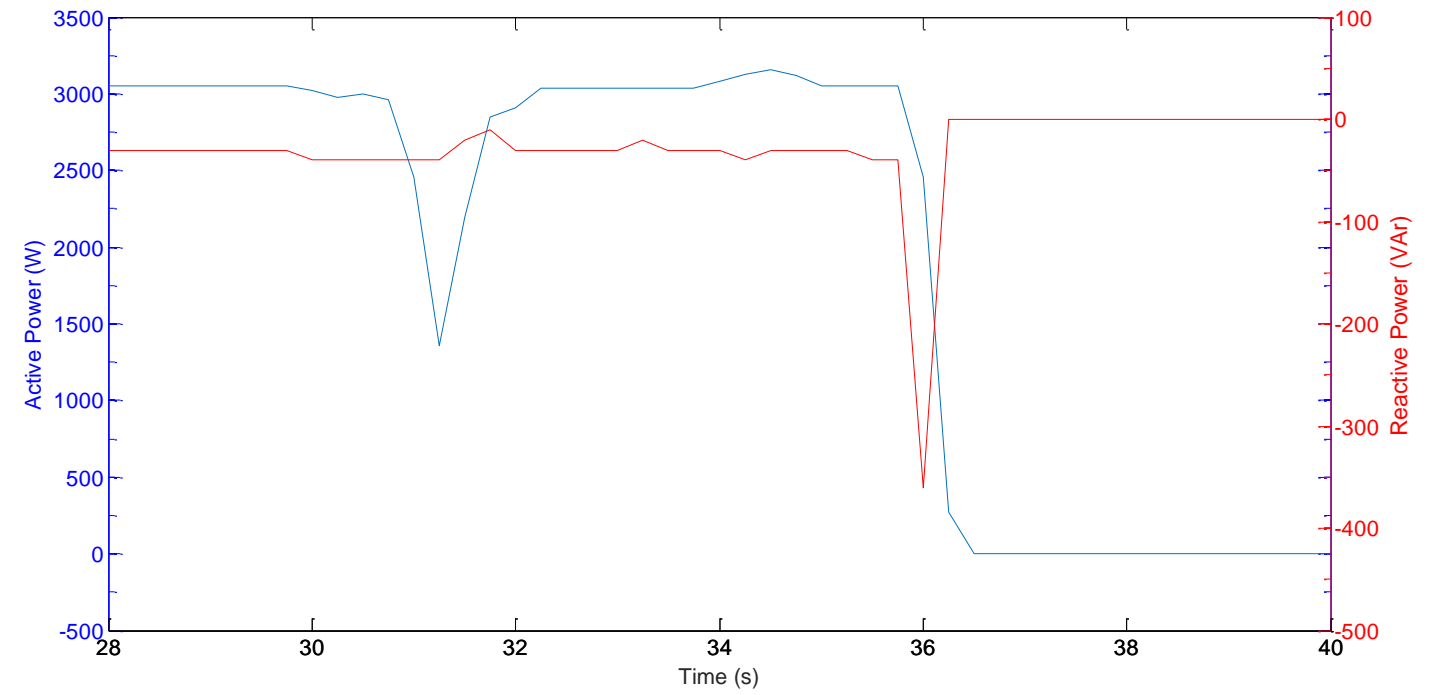


Figure 27 ABB inverter output active and reactive powers

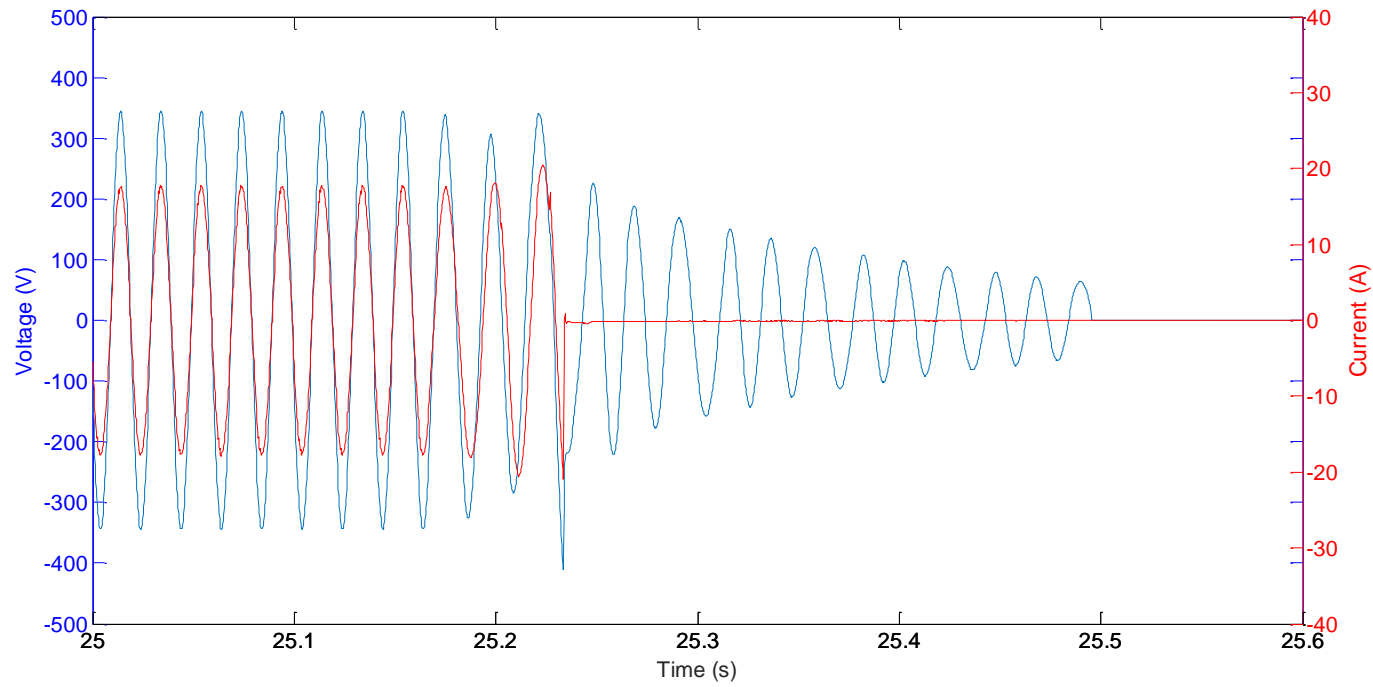


Figure 28 SMA inverter output current and voltage

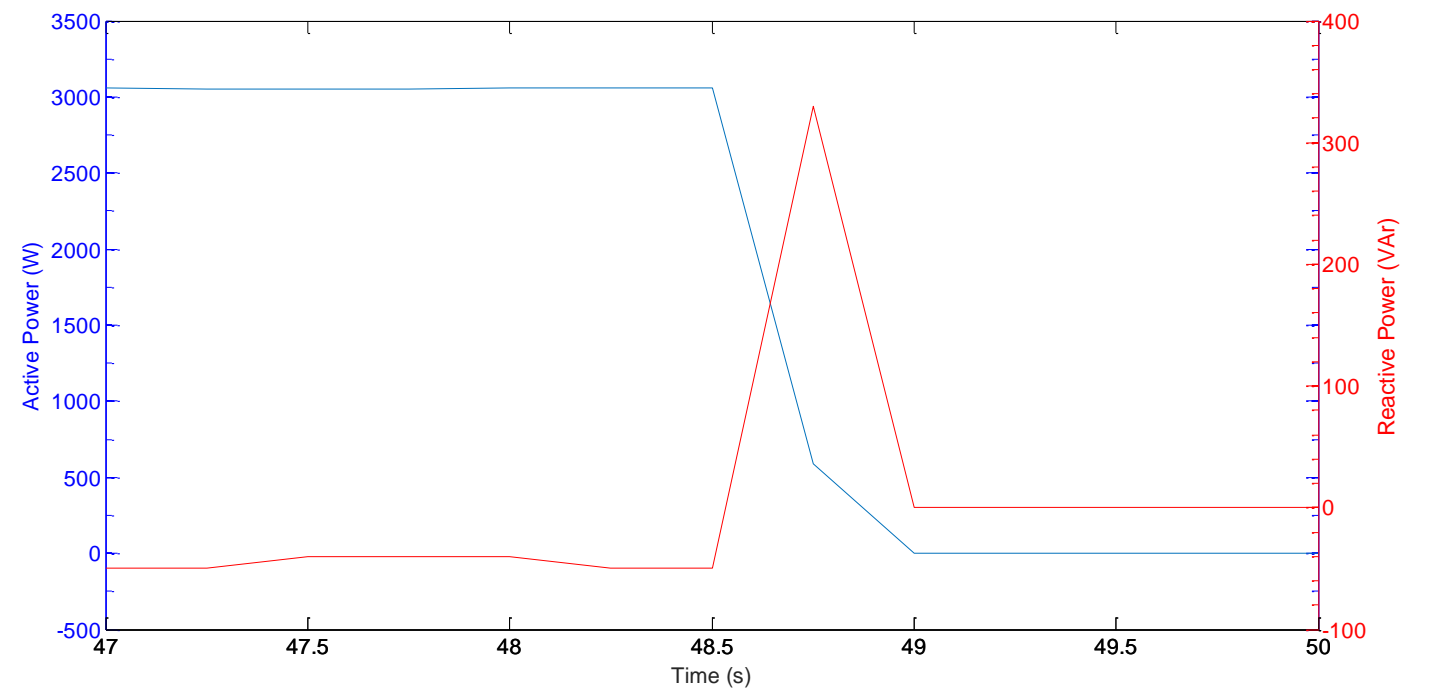


Figure 29 SMA inverter output active and reactive power

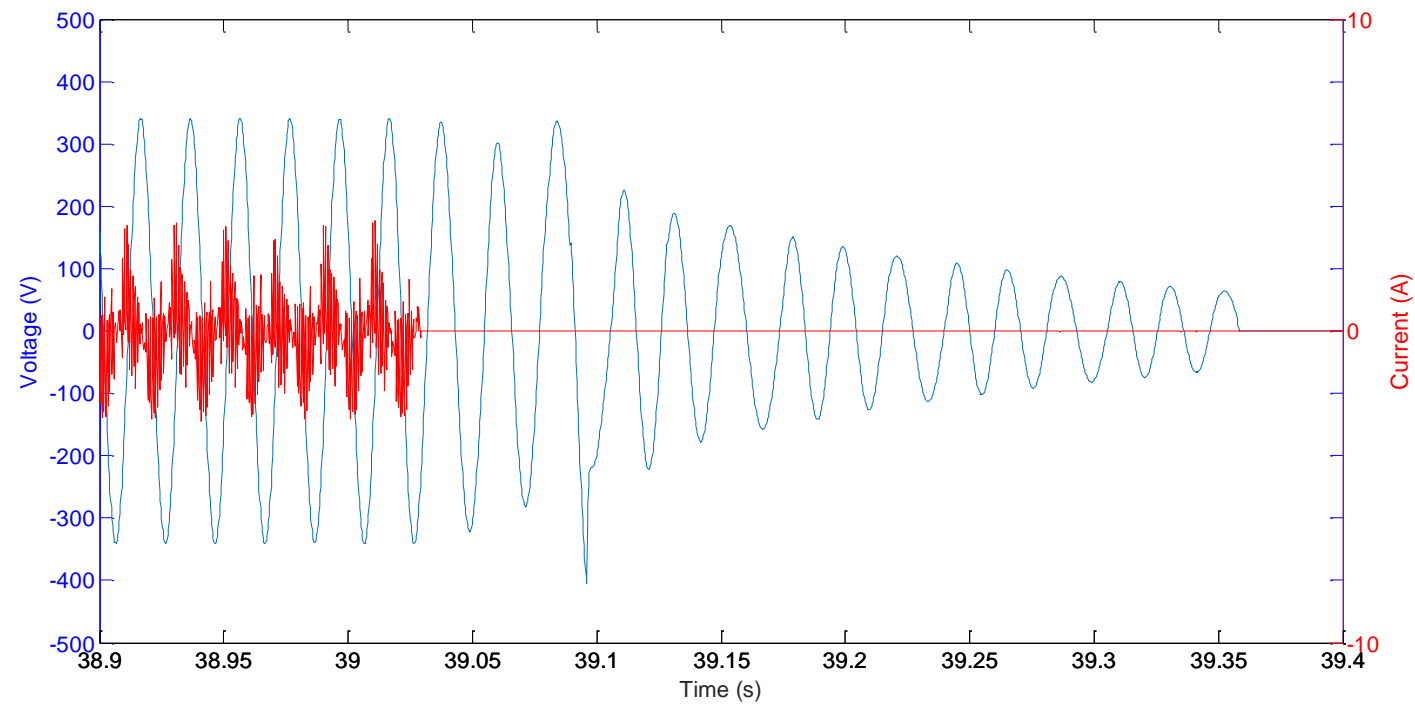


Figure 30 PCC current and voltage

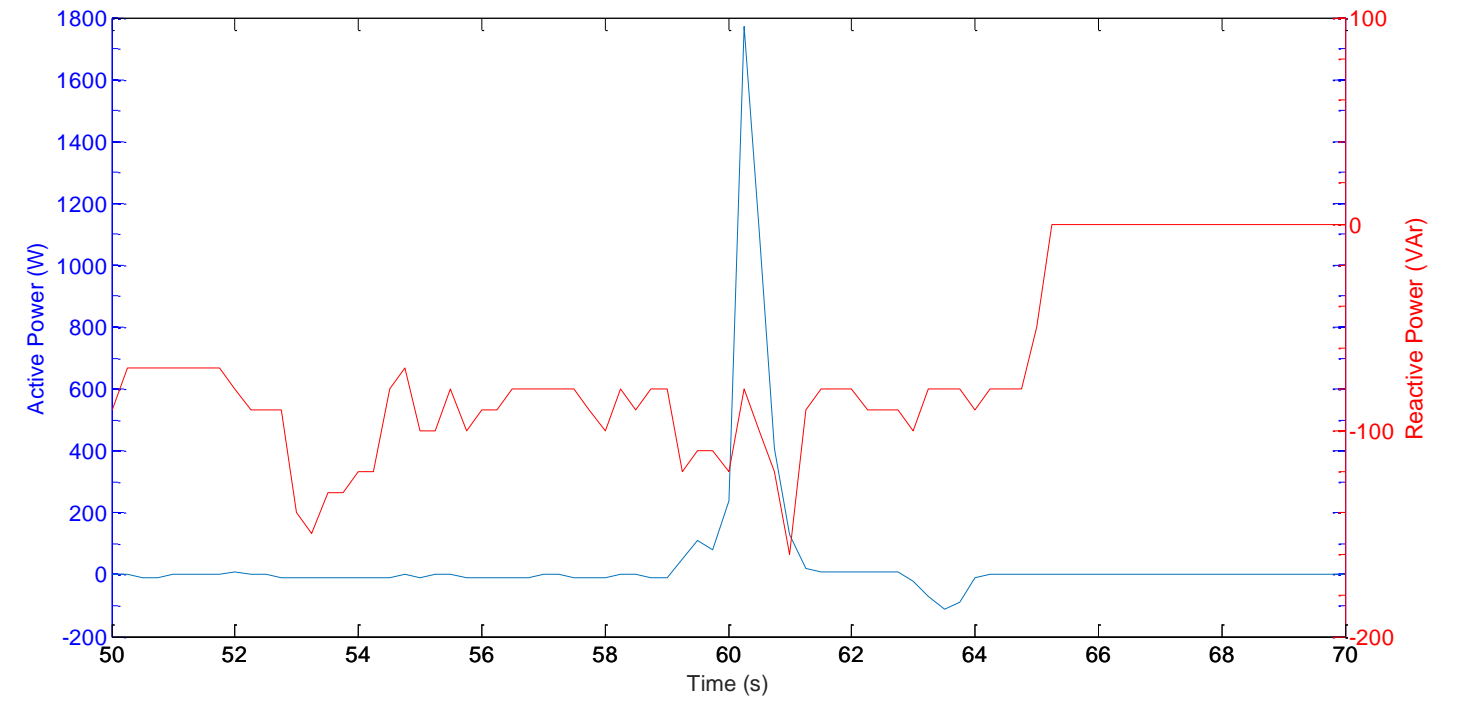


Figure 31 PCC active and reactive powers flow

ABB and Kaco inverters connected simultaneously

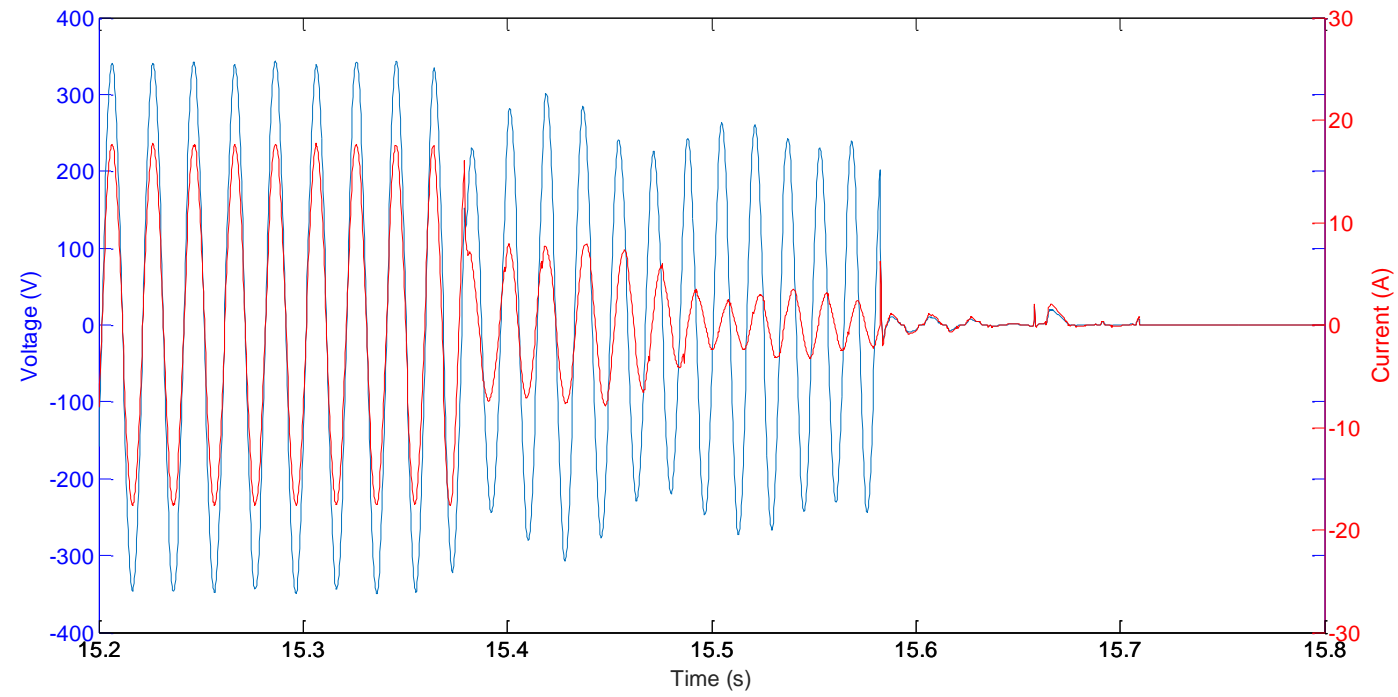


Figure 32 ABB inverter output current and voltage

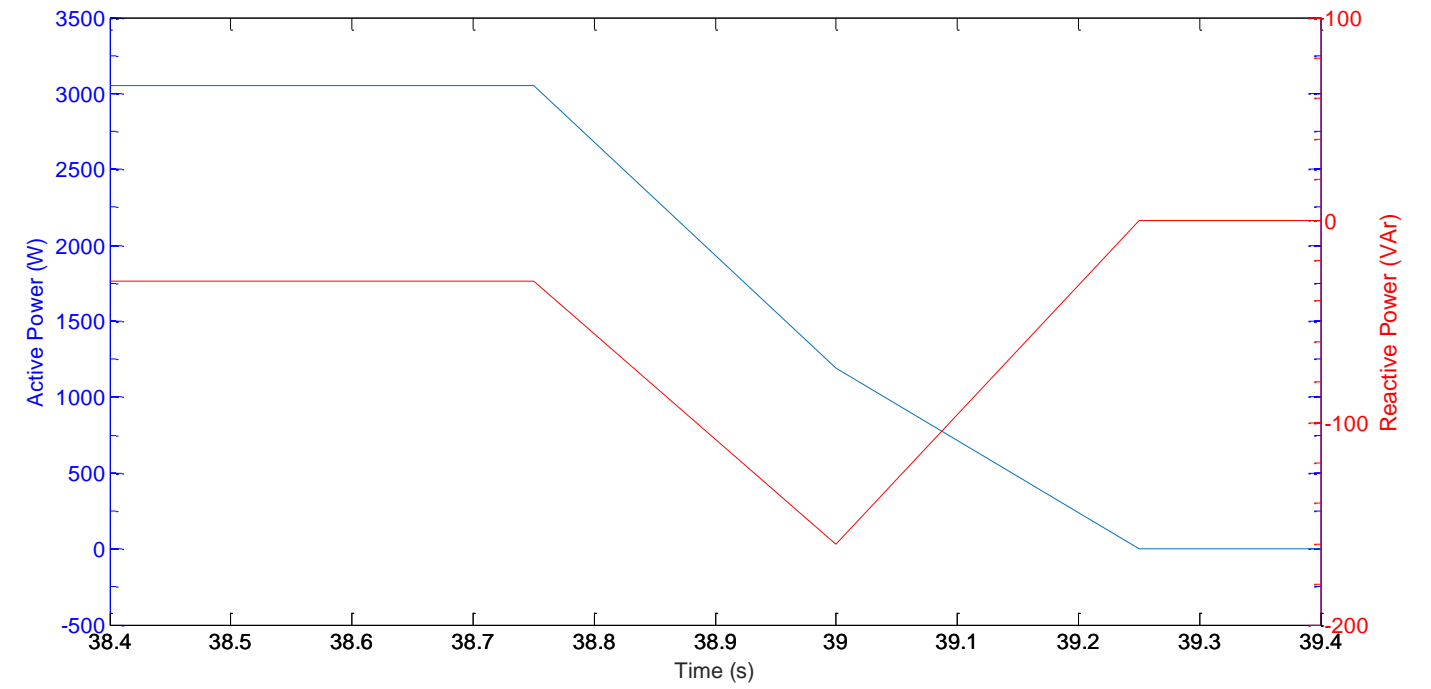


Figure 33 ABB inverter output active and reactive powers

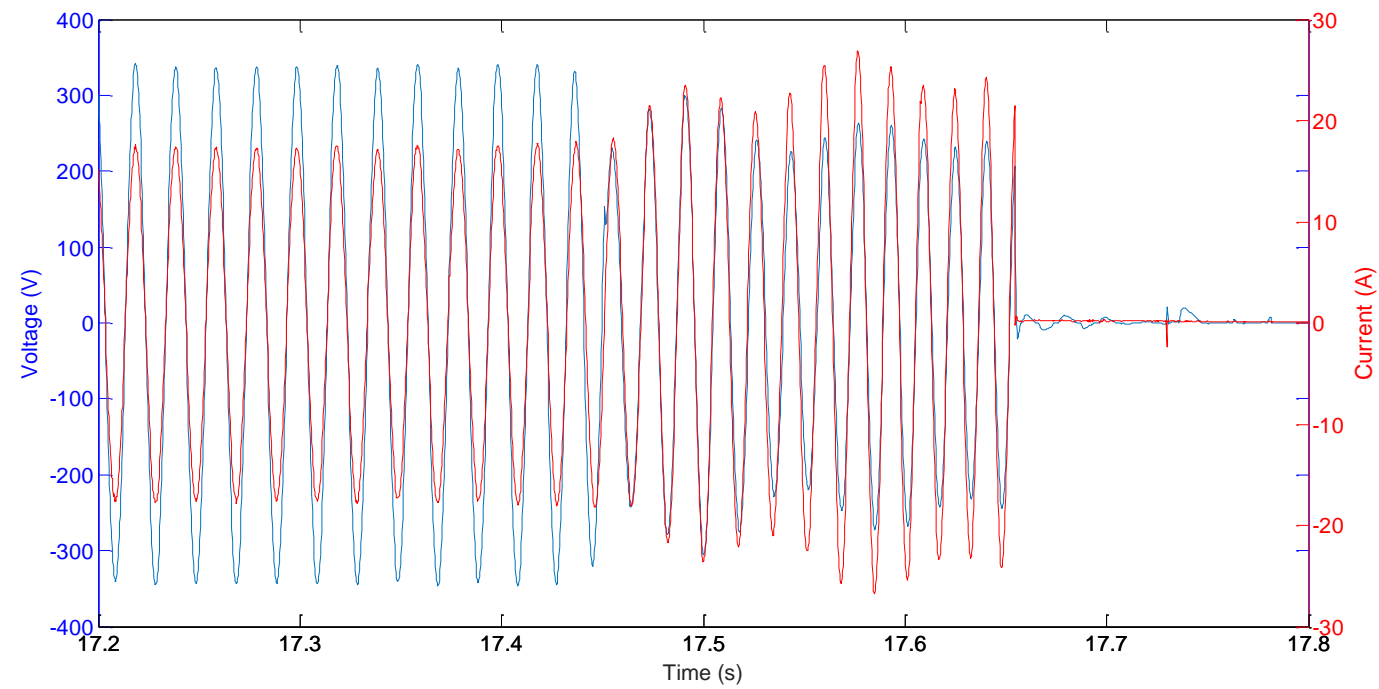


Figure 34 Kaco inverter output current and voltage

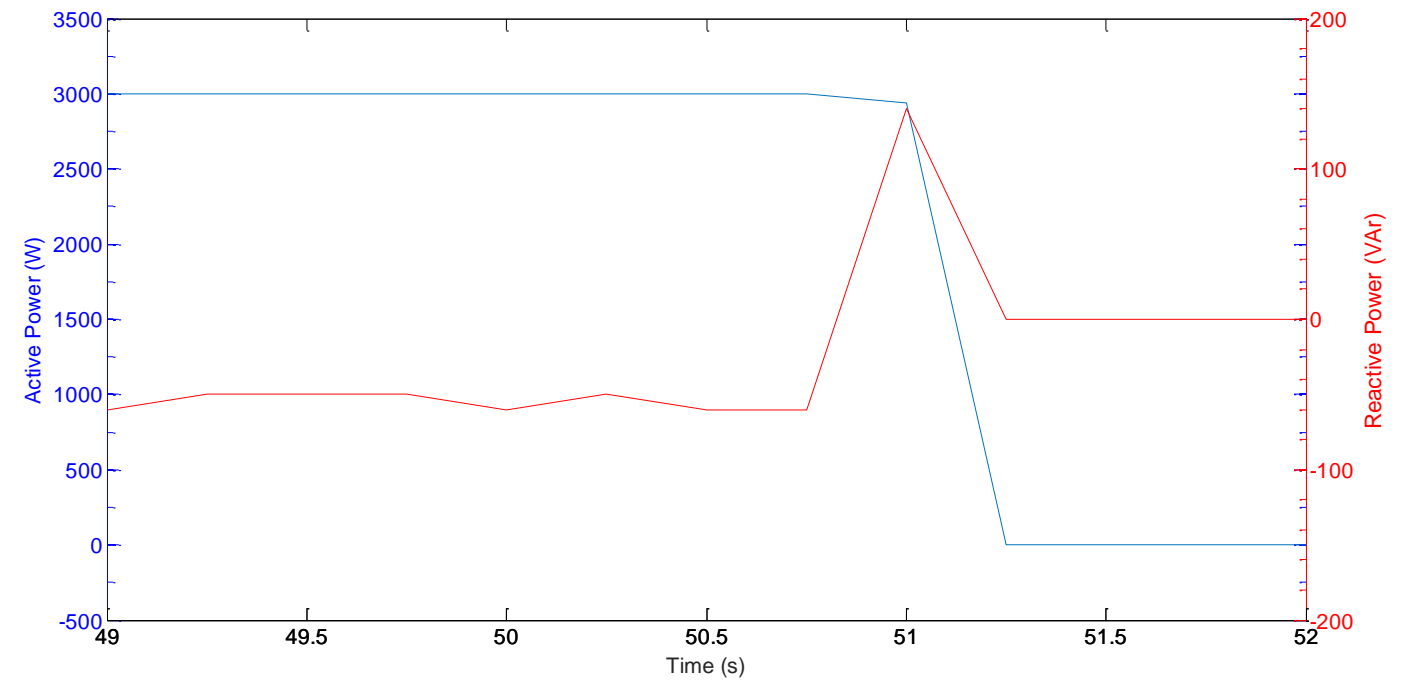


Figure 35 Kaco inverter output active and reactive power

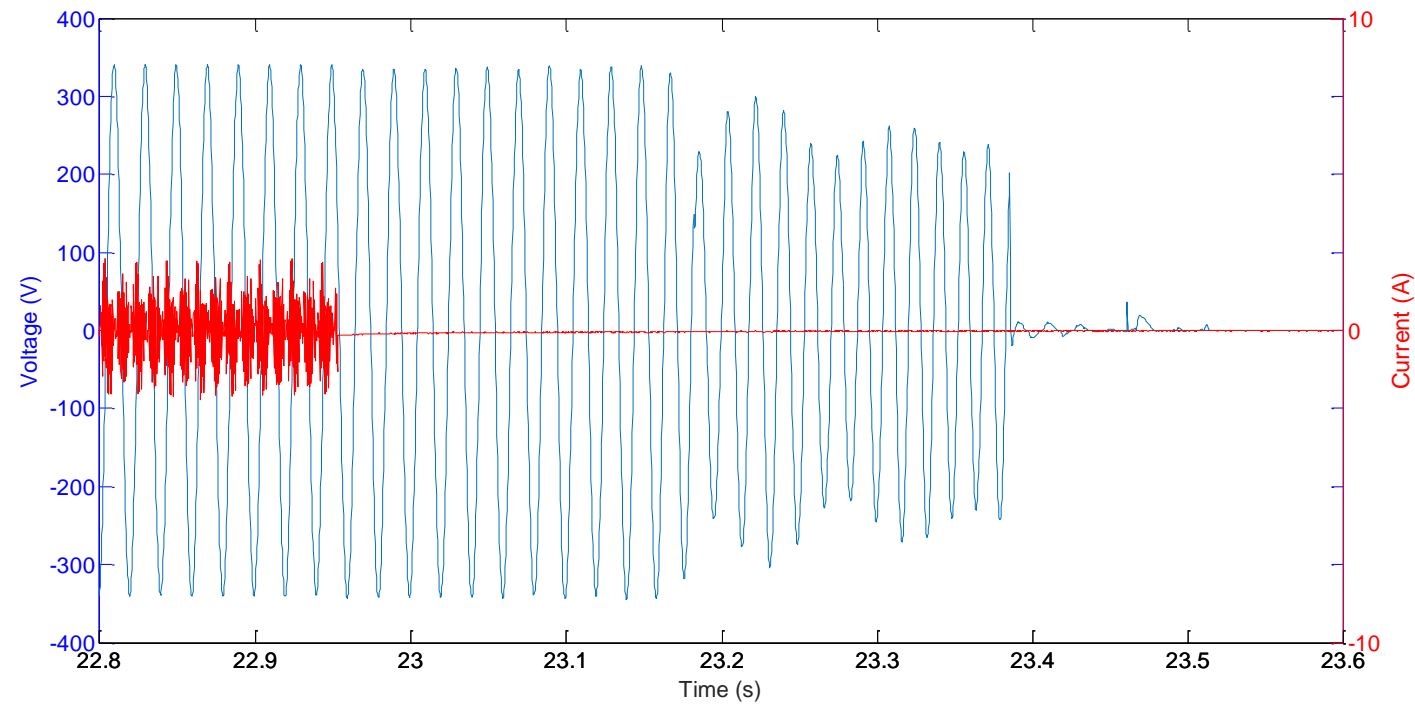


Figure 36 PCC current and voltage

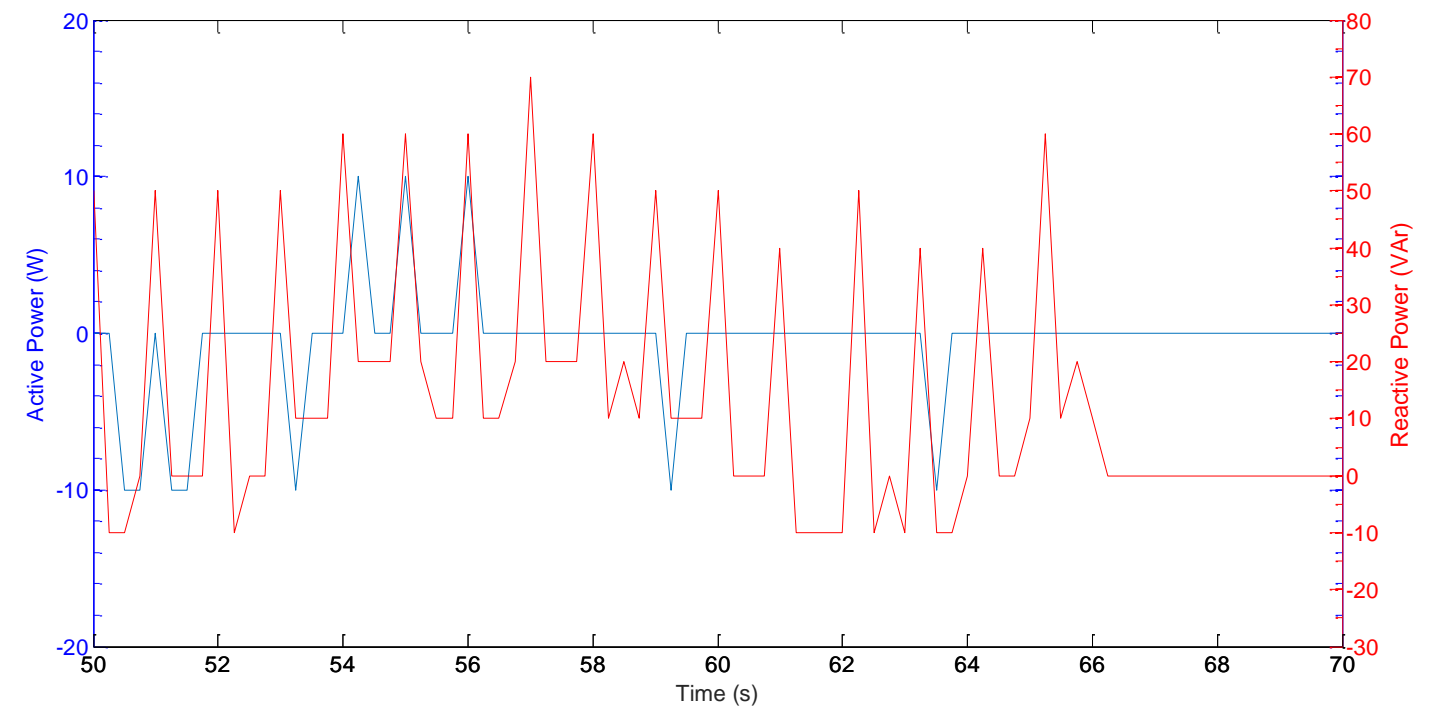
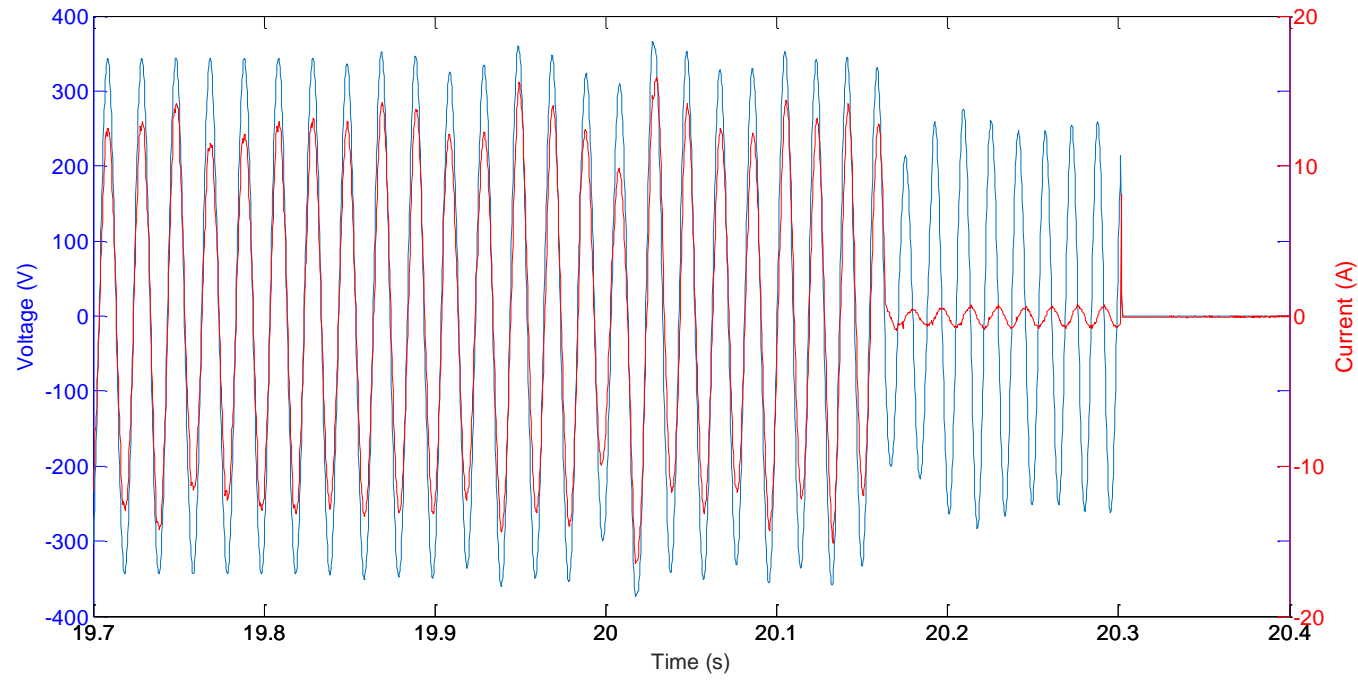
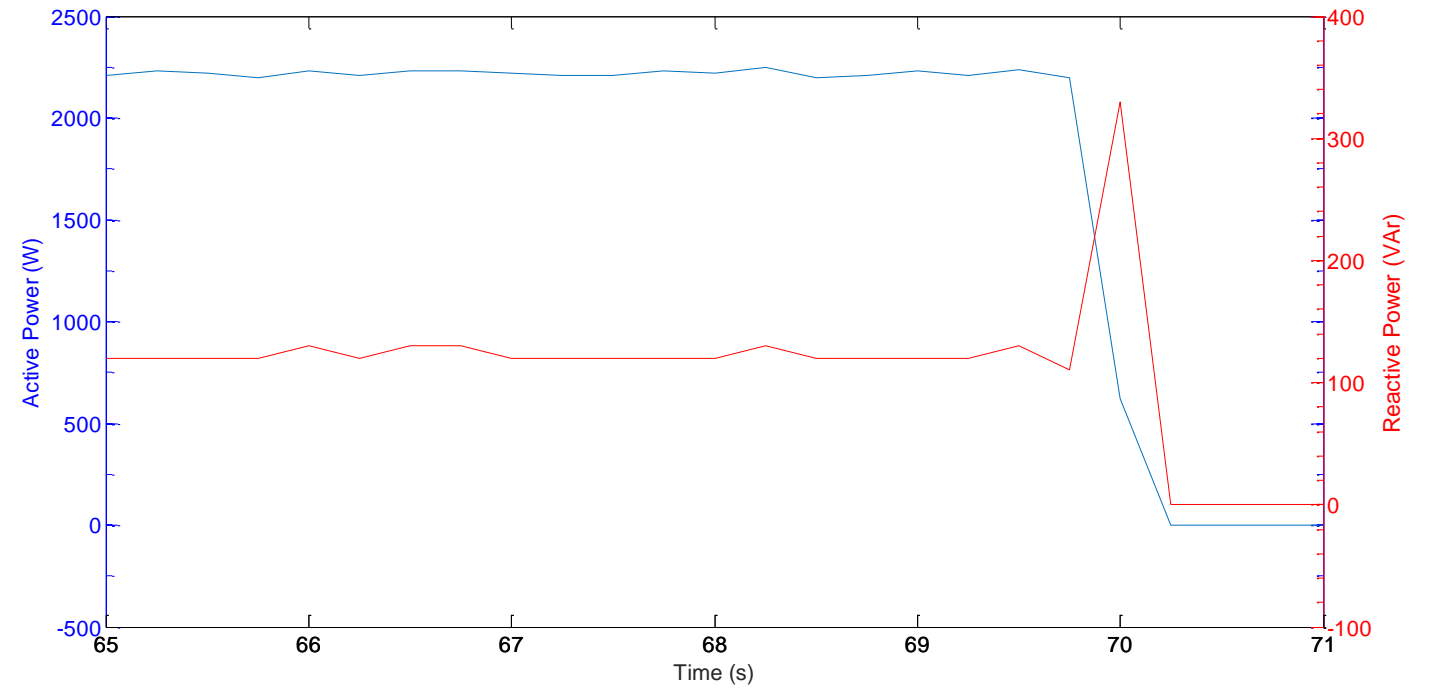


Figure 37 PCC active and reactive powers flow

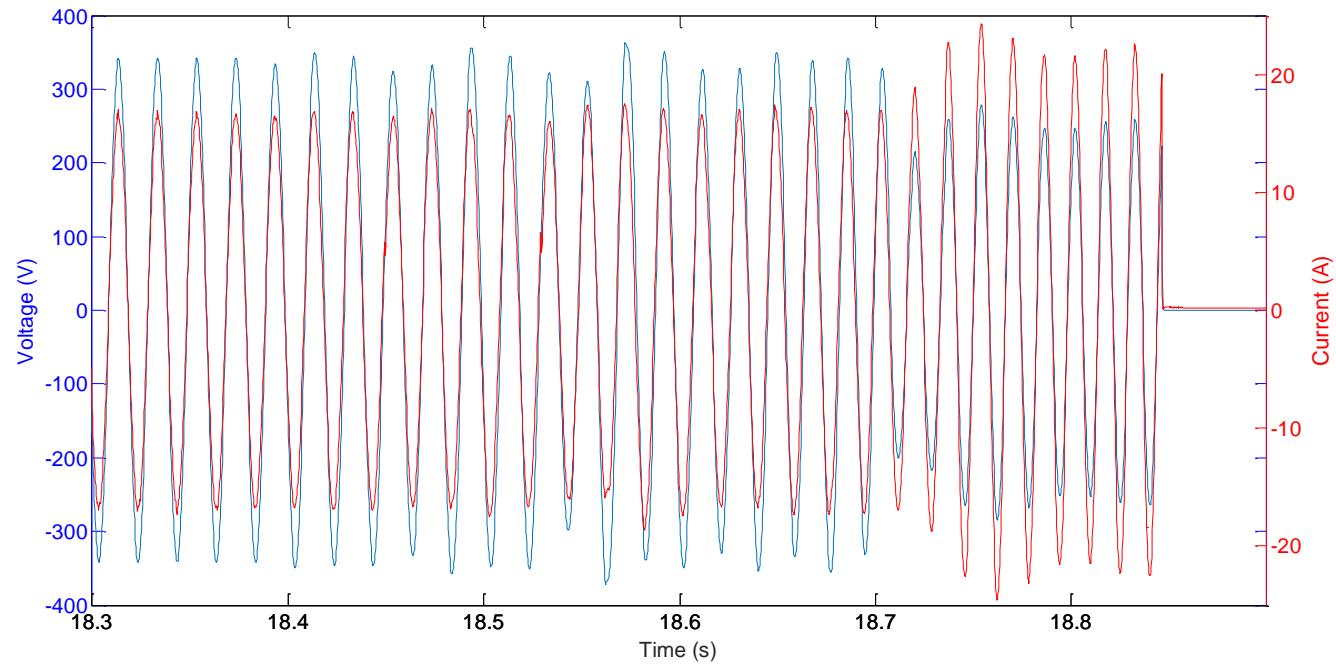
Fronius and Kaco inverters connected simultaneously



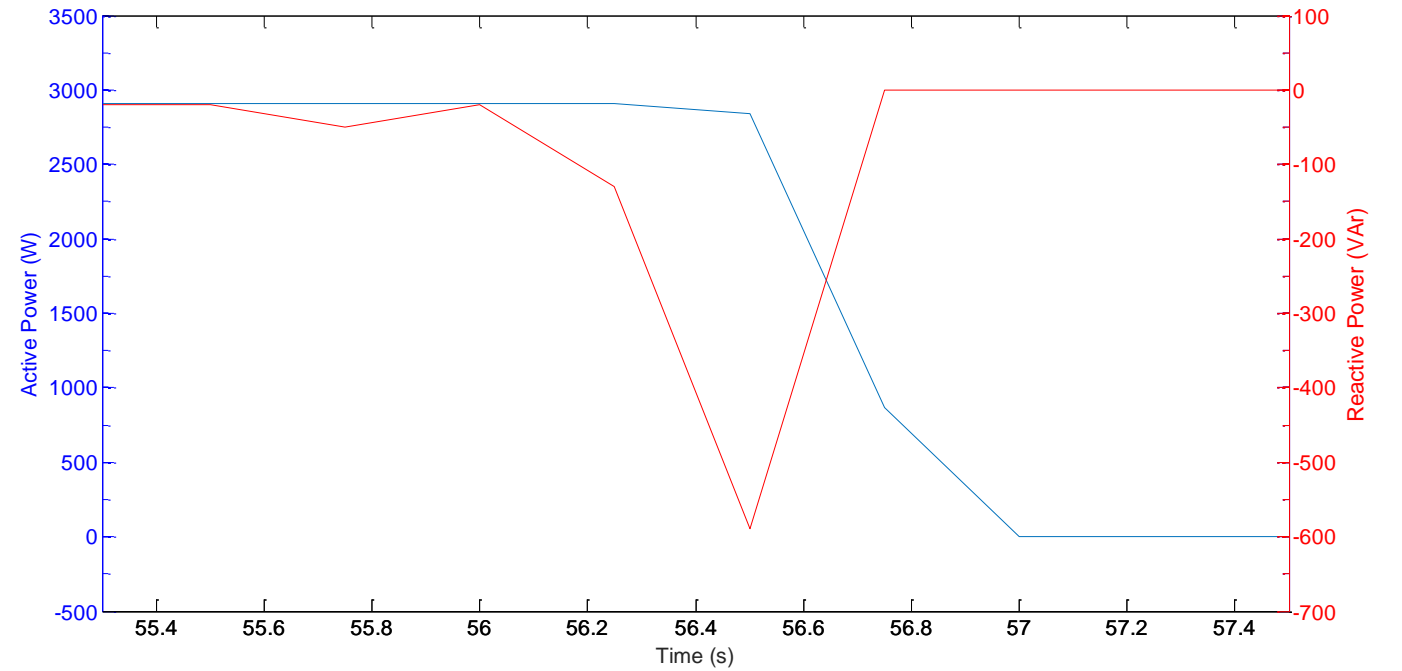
**Figure 38 Fronius inverter output current and voltage**



**Figure 39 Fronius inverter output active and reactive powers**



**Figure 40 Kaco inverter output current and voltage**



**Figure 41 Kaco inverter output active and reactive power**

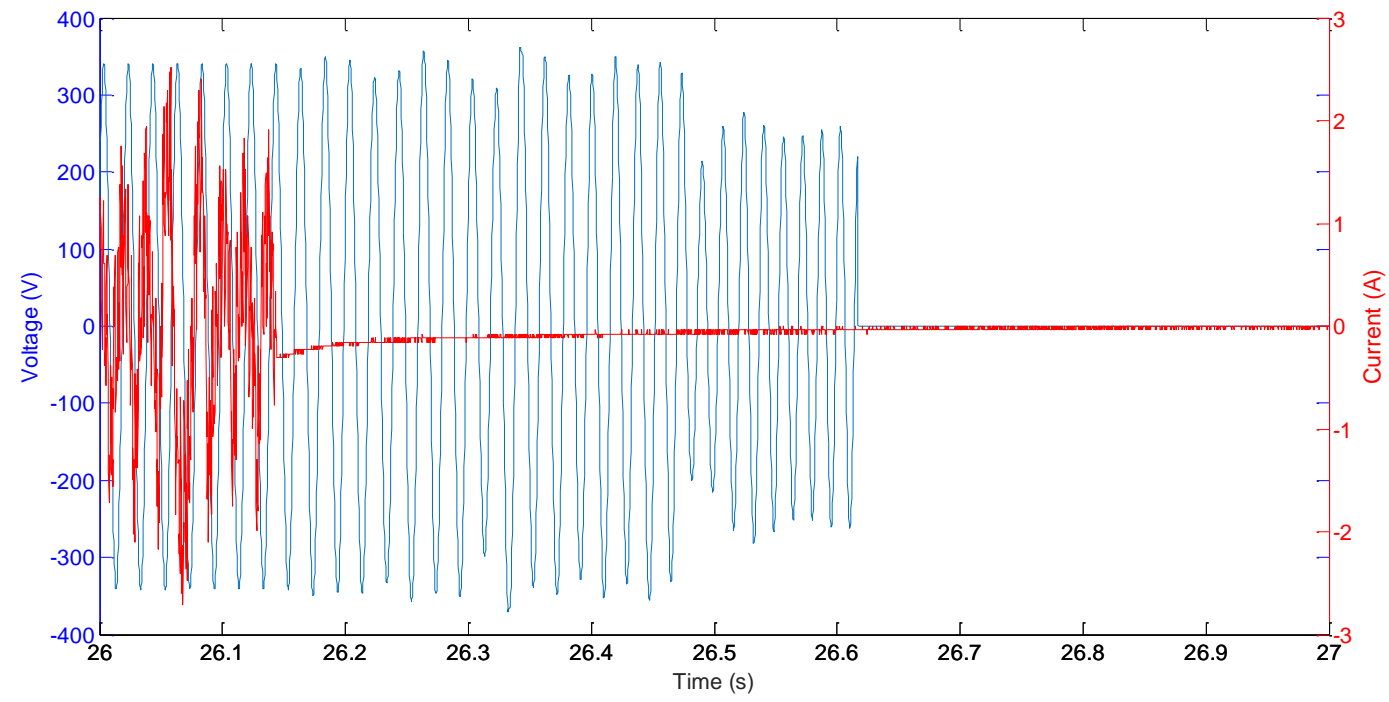


Figure 42 PCC current and voltage

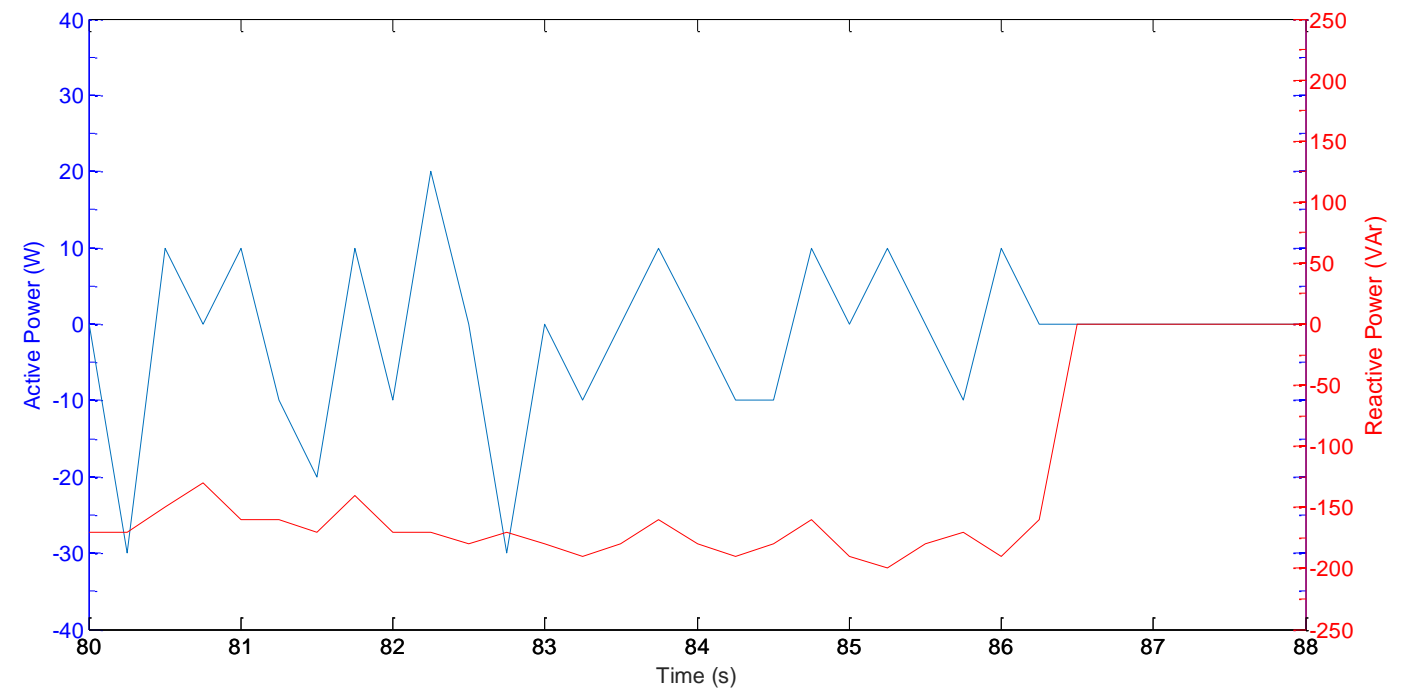


Figure 43 PCC active and reactive powers flow



Kaco and SMA inverters connected simultaneously

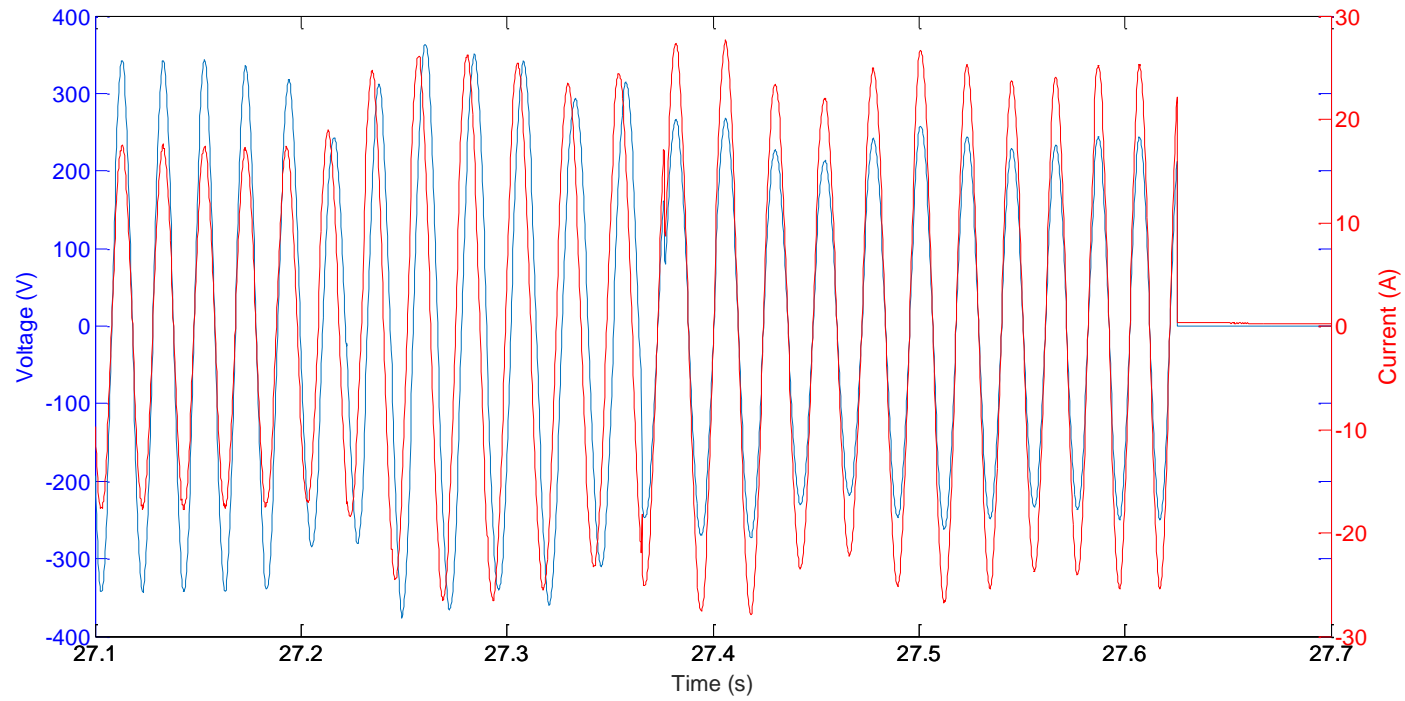


Figure 44 Kaco inverter output current and voltage

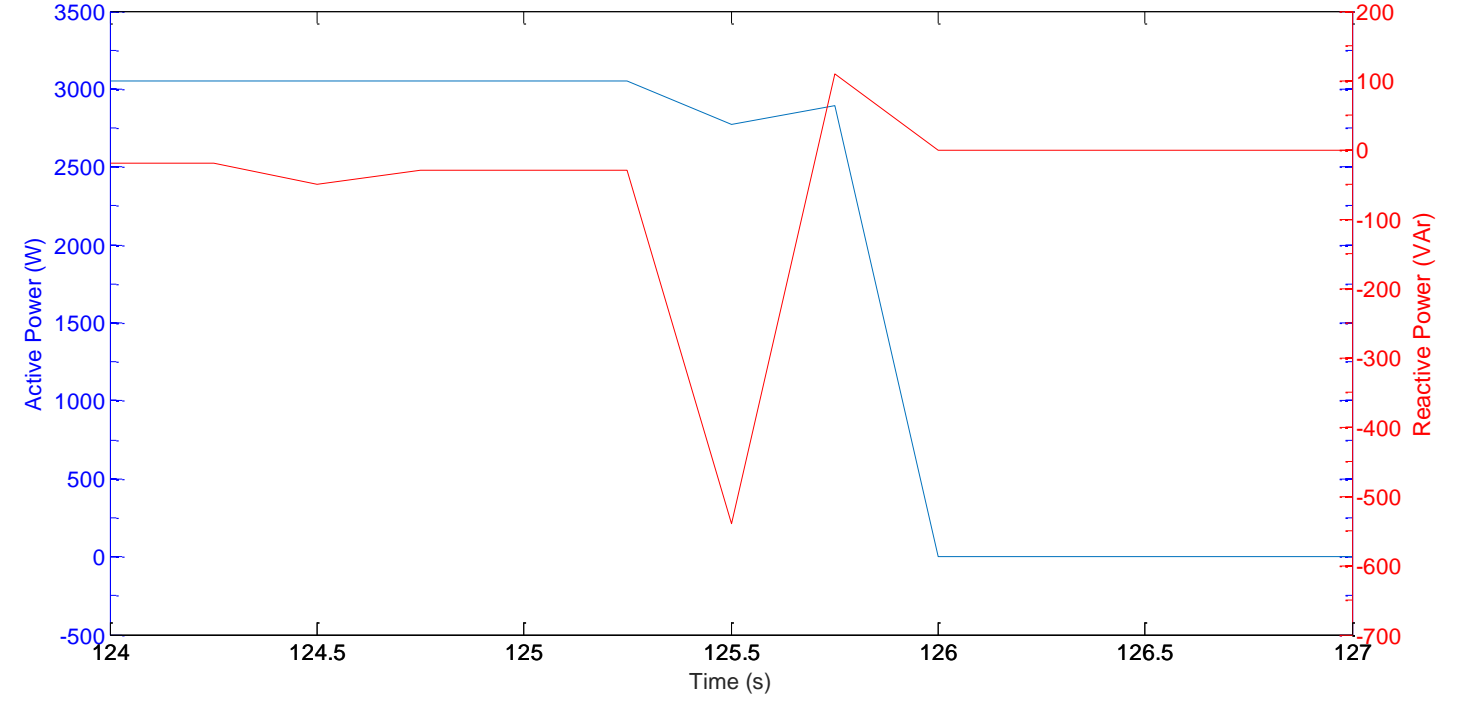


Figure 45 Kaco inverter output active and reactive powers

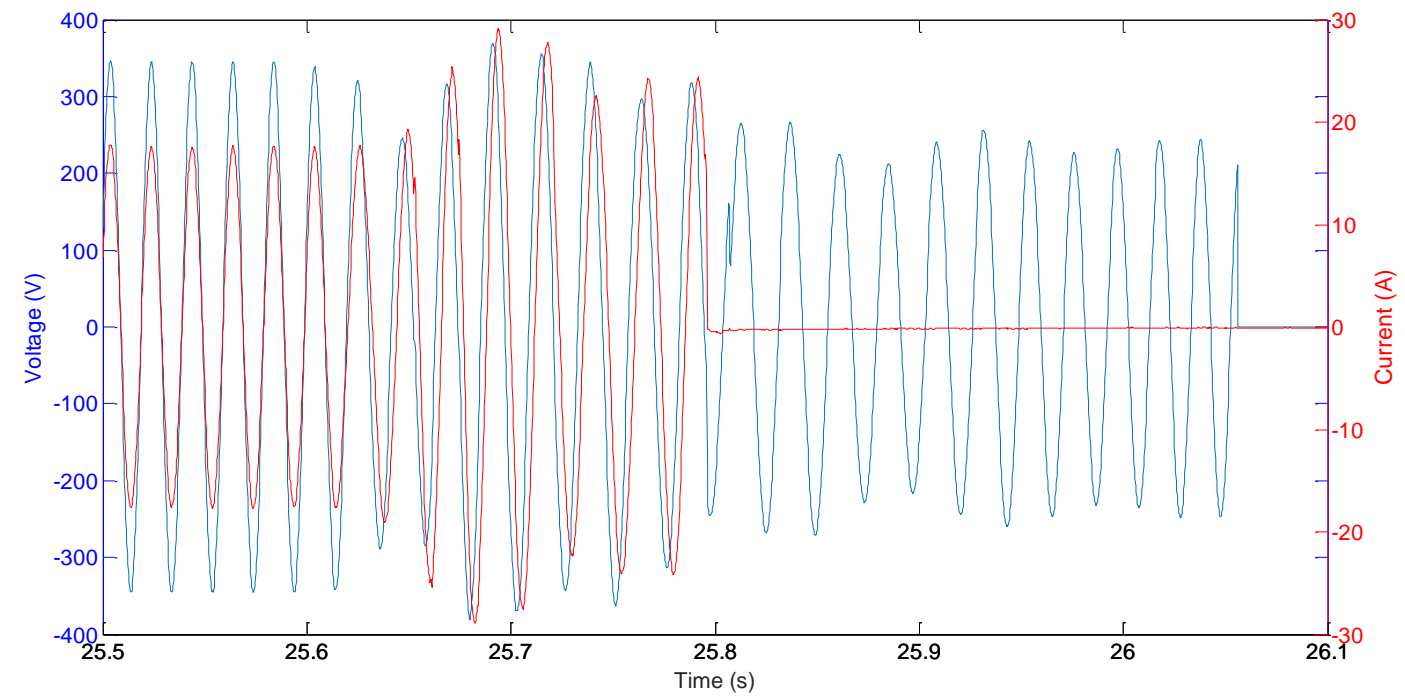


Figure 46 SMA inverter output current and voltage

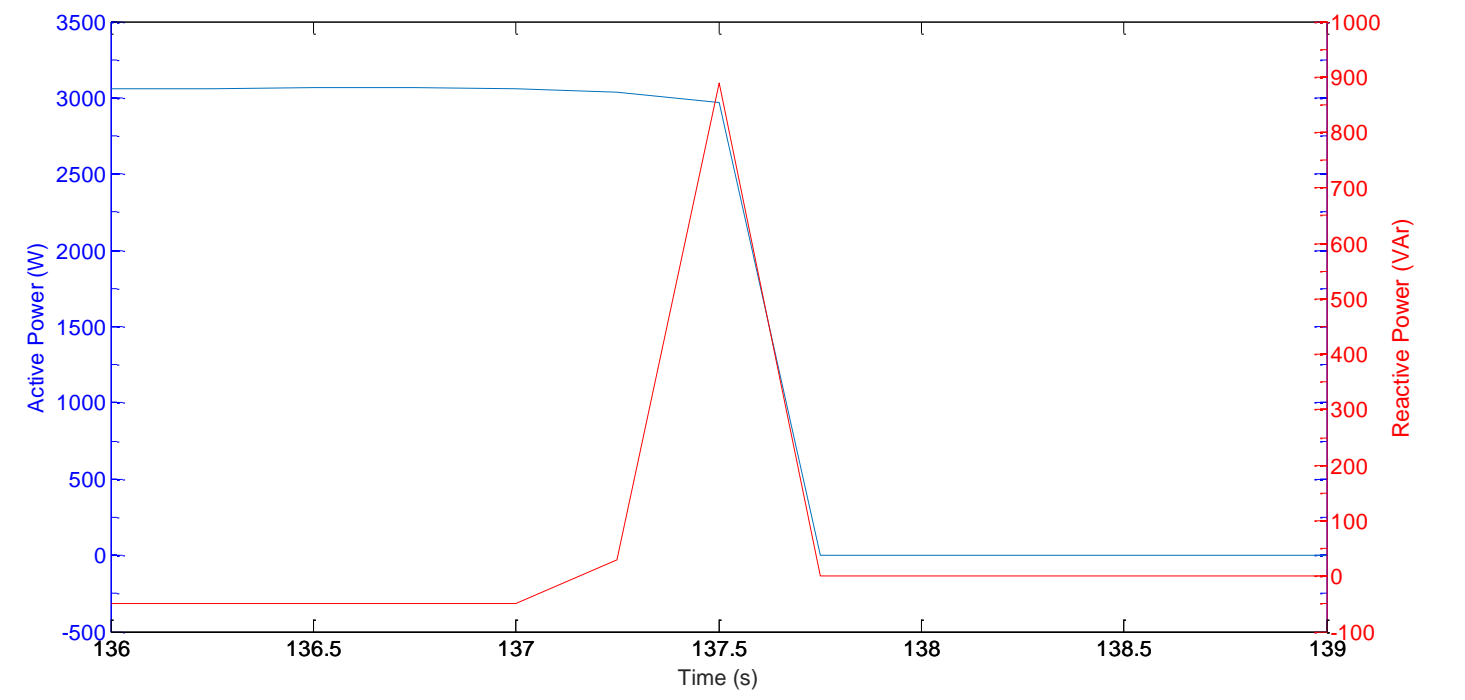


Figure 47 SMA inverter output active and reactive power

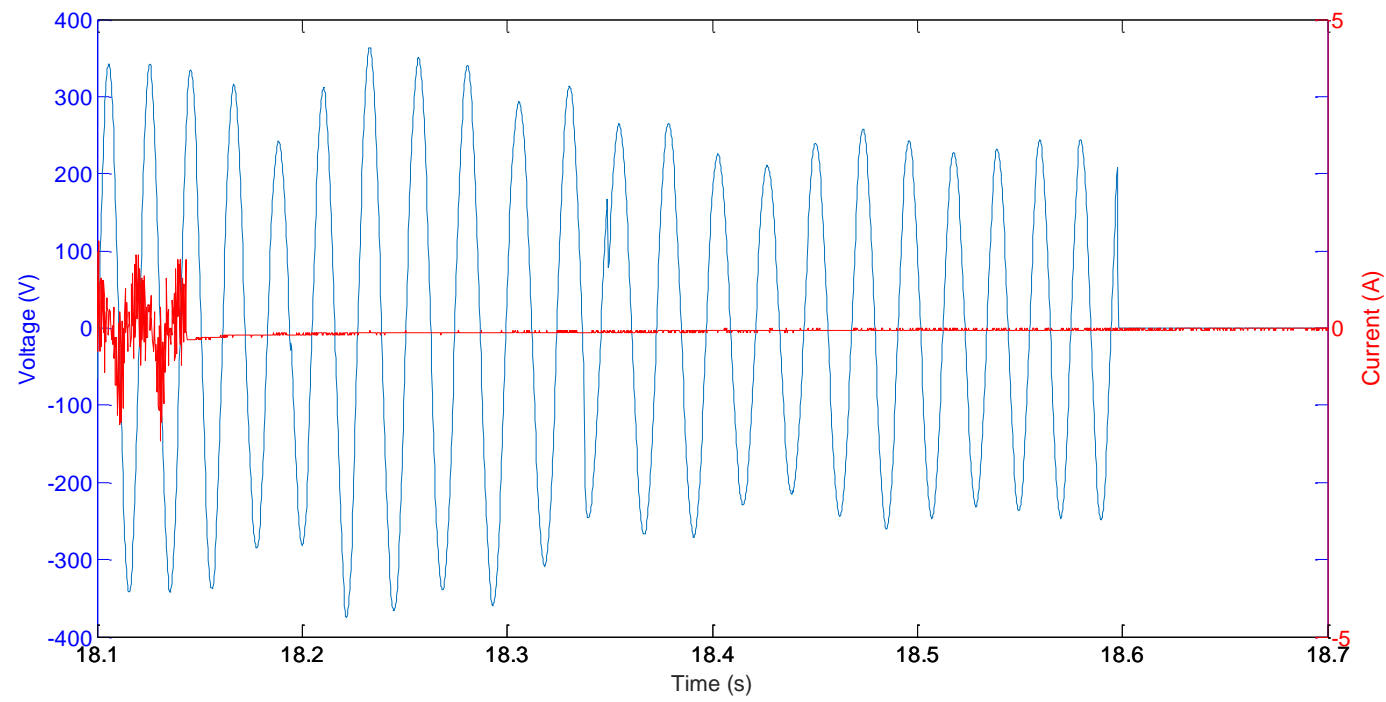


Figure 48 PCC current and voltage

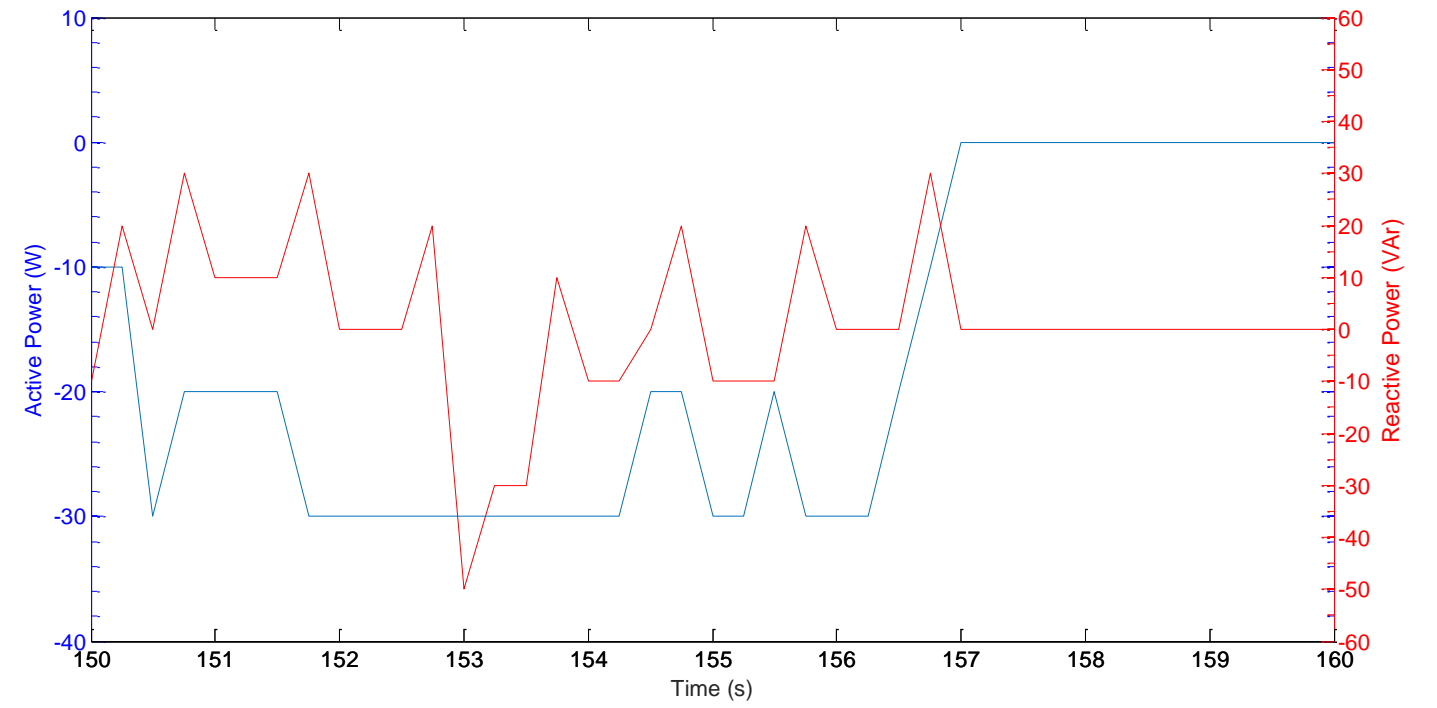


Figure 49 PCC active and reactive powers flow

## Appendix B – Graphs of category 2 test measurements

ABB inverter only connected – 1Hz/s event

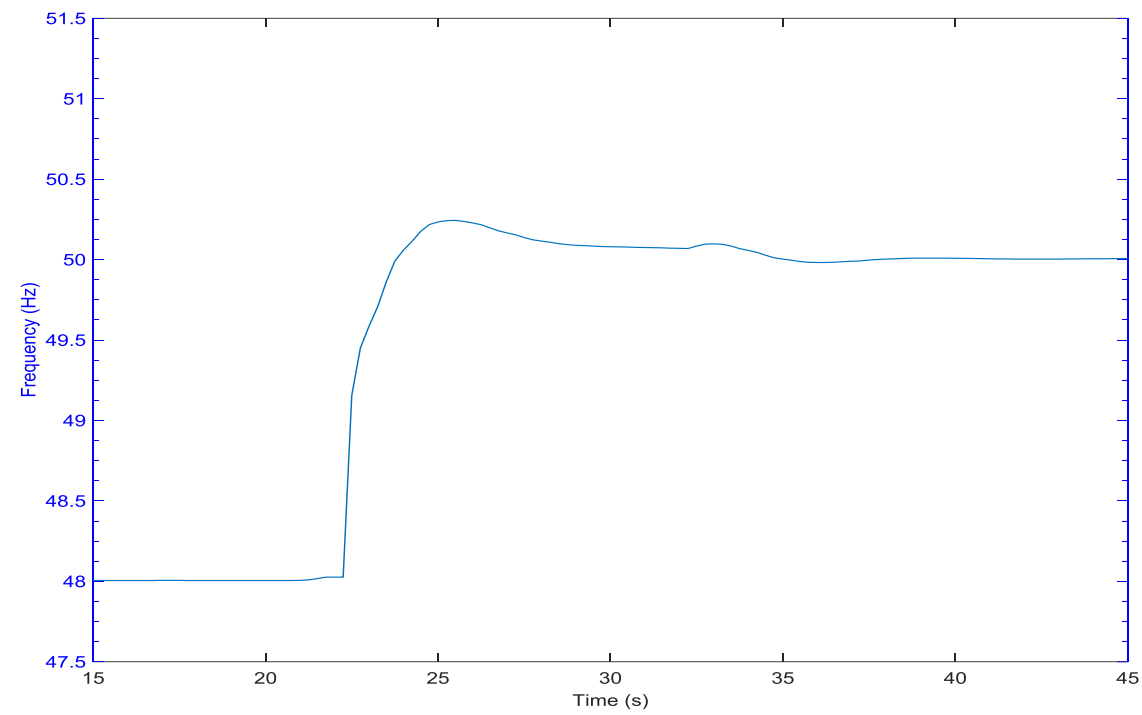


Figure 50 Average frequency during +1Hz/s event

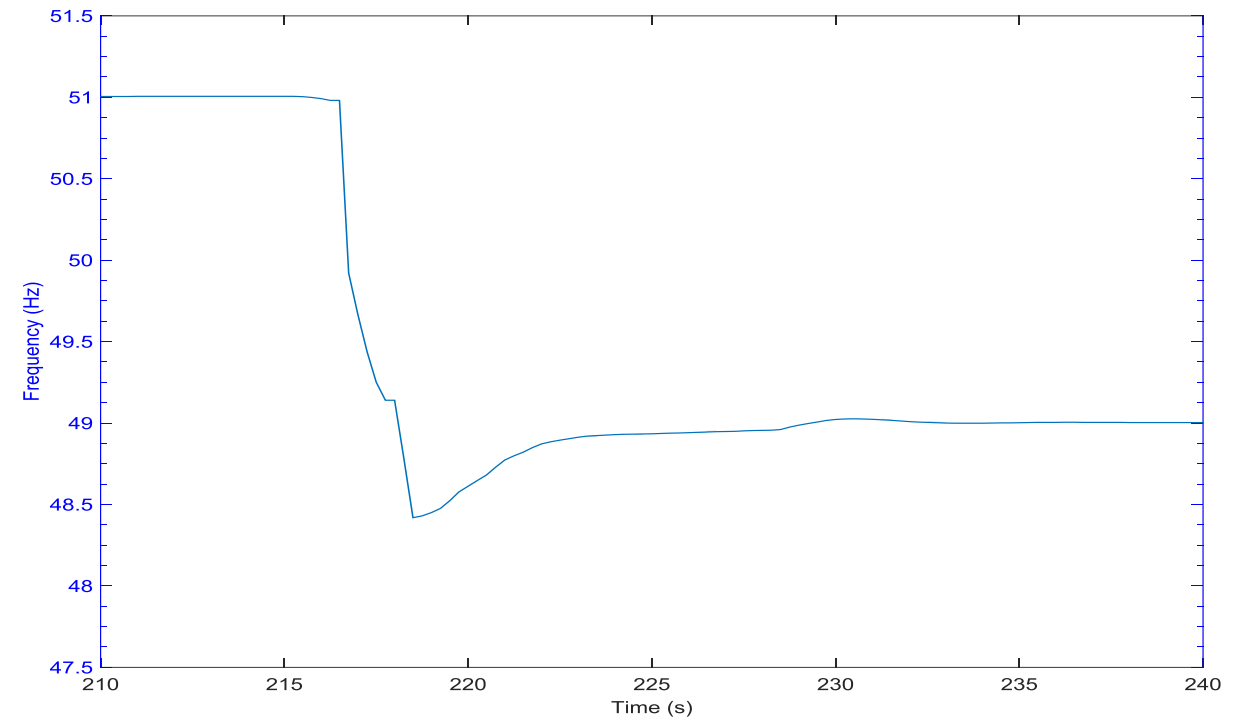


Figure 51 Average frequency during -1Hz/s event

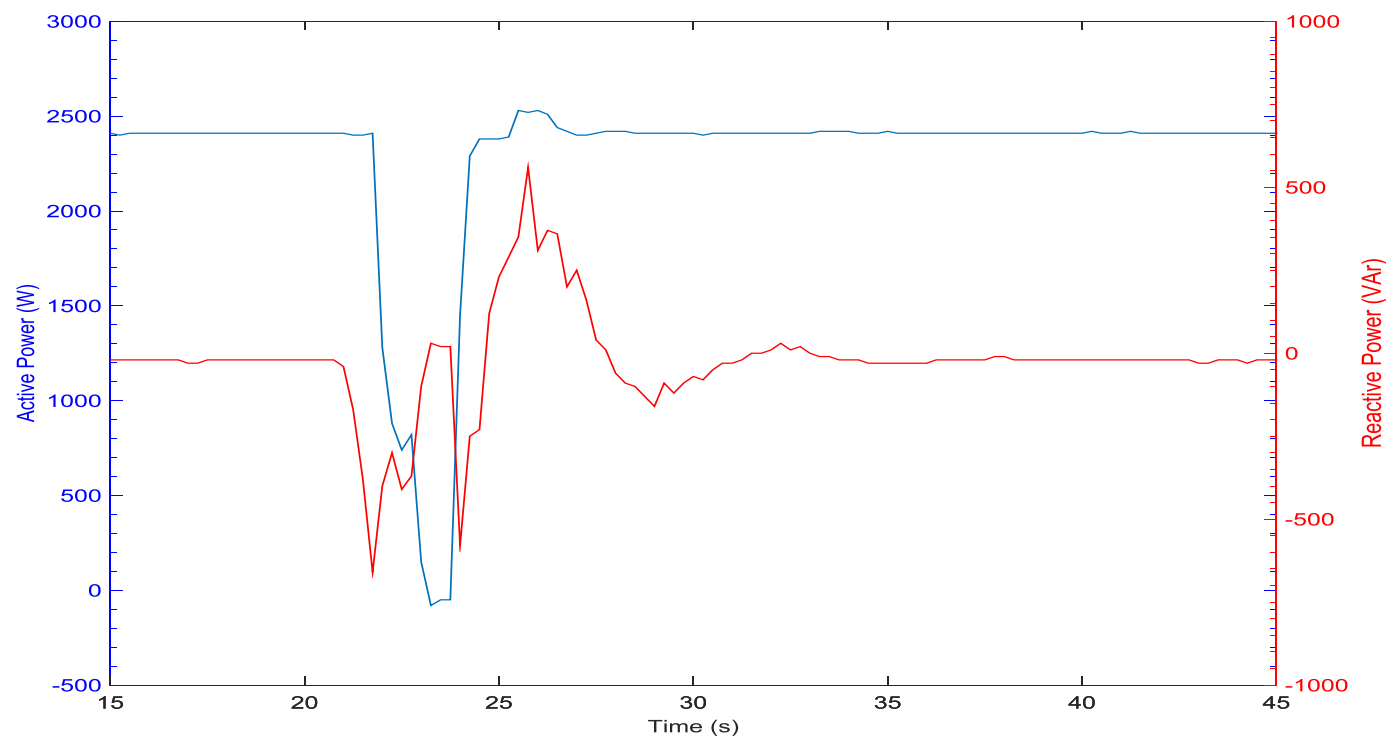


Figure 52 ABB inverter output active and reactive powers during +1Hz/s event

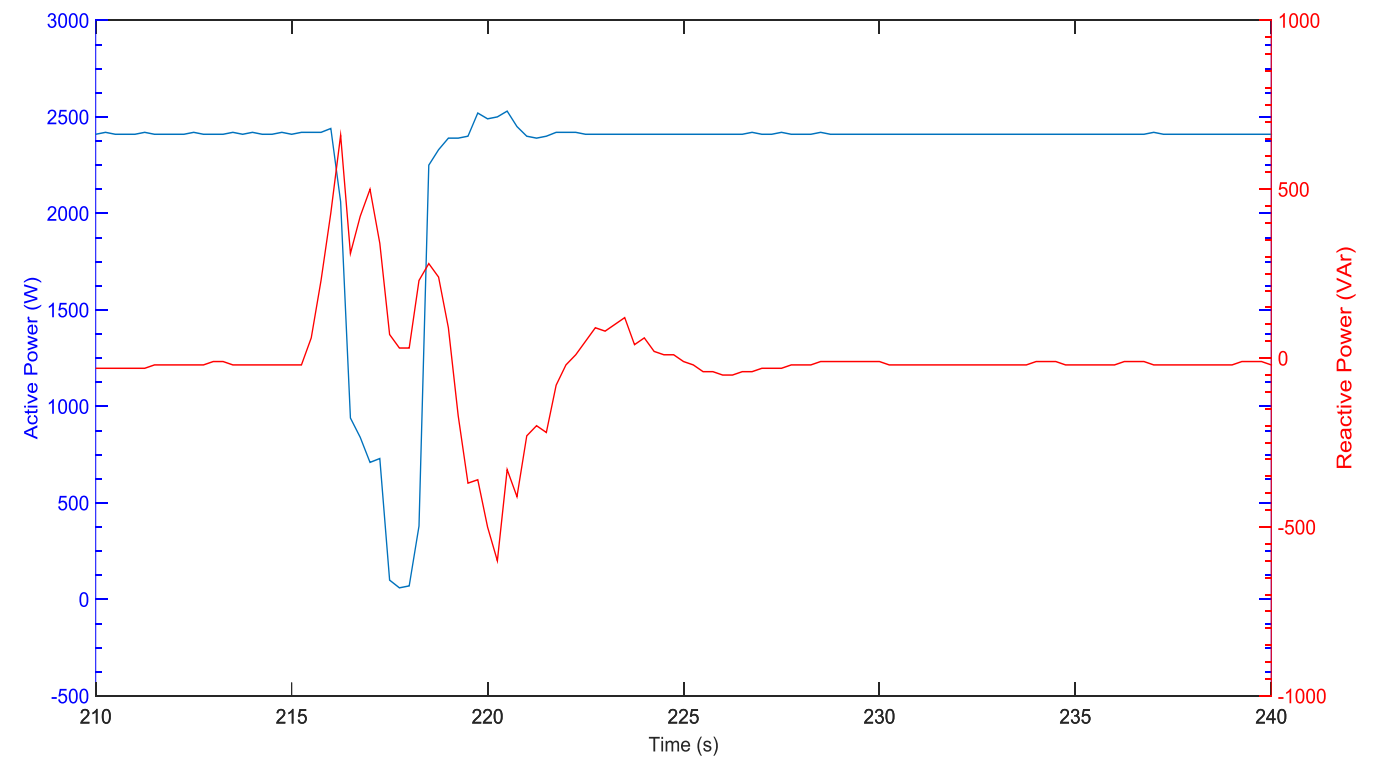
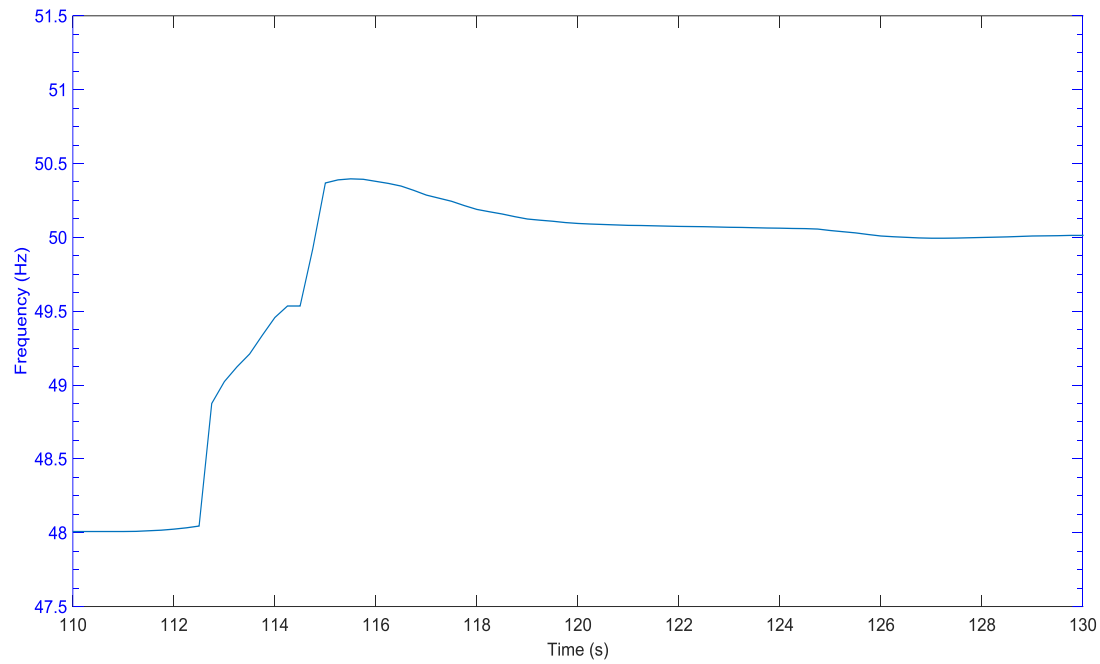
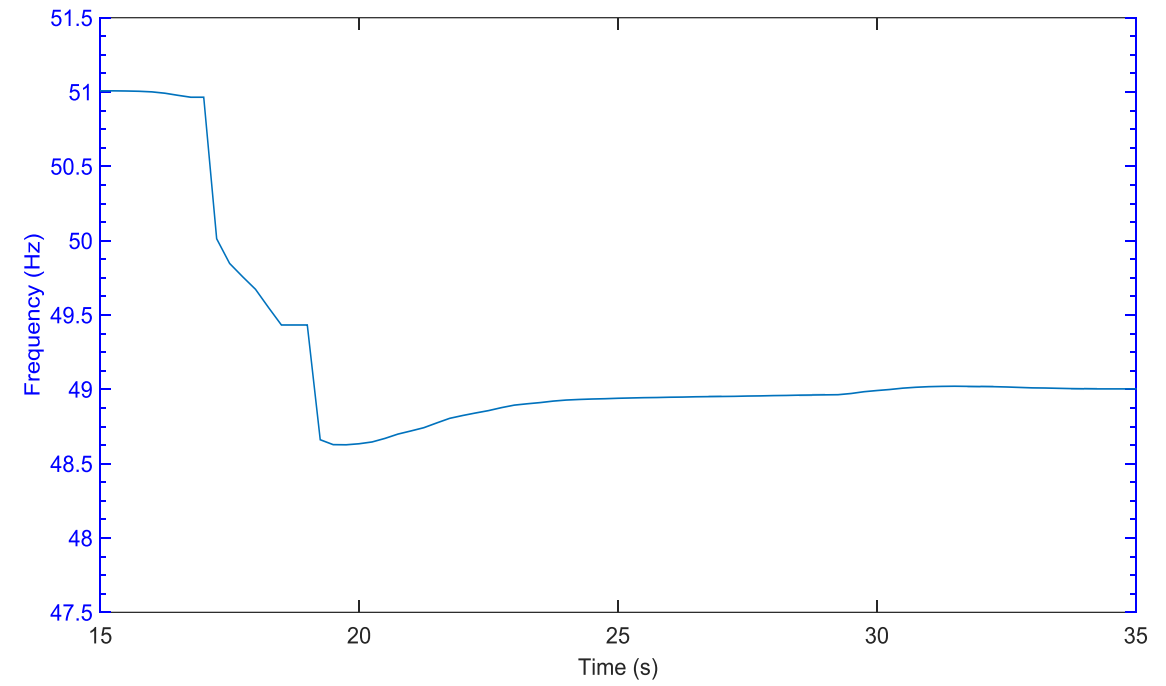


Figure 53 ABB inverter output active and reactive powers during -1Hz/s event

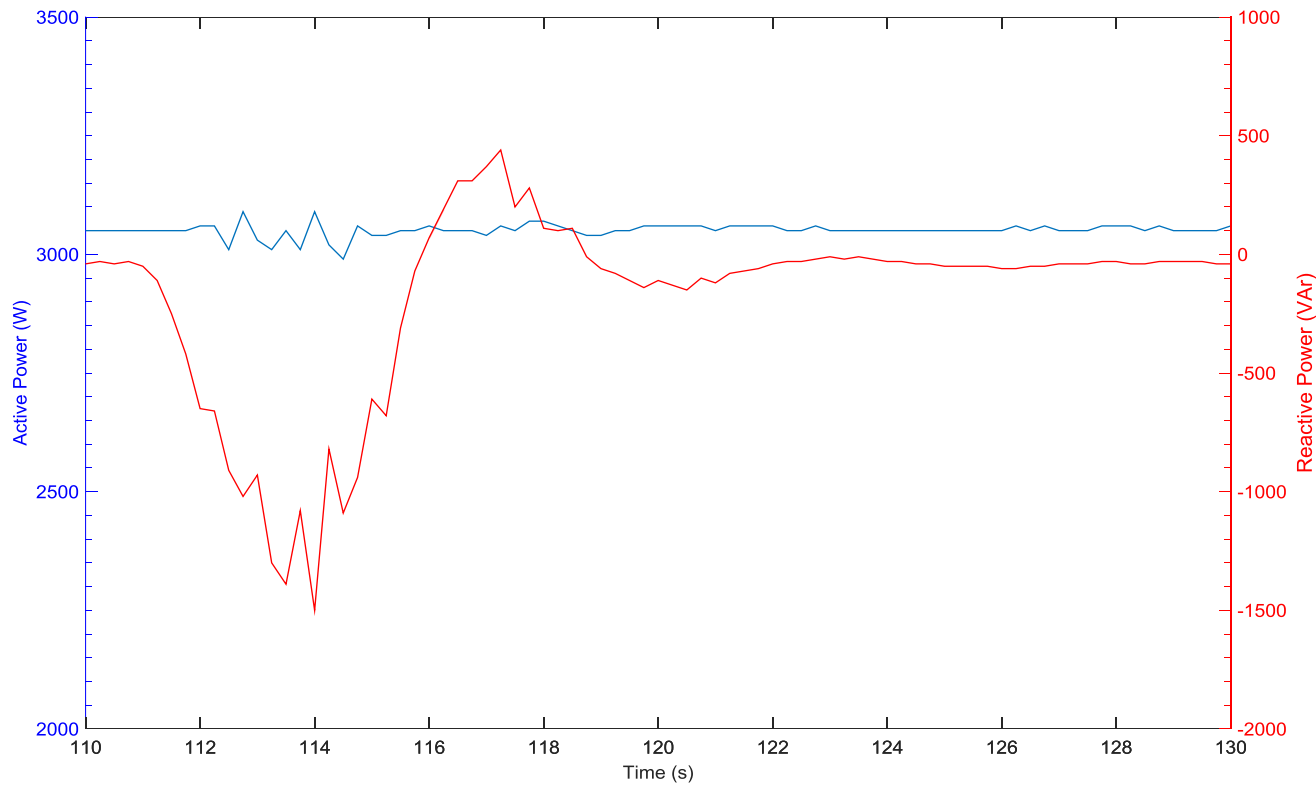
ABB inverter only connected – 0.6Hz/s event



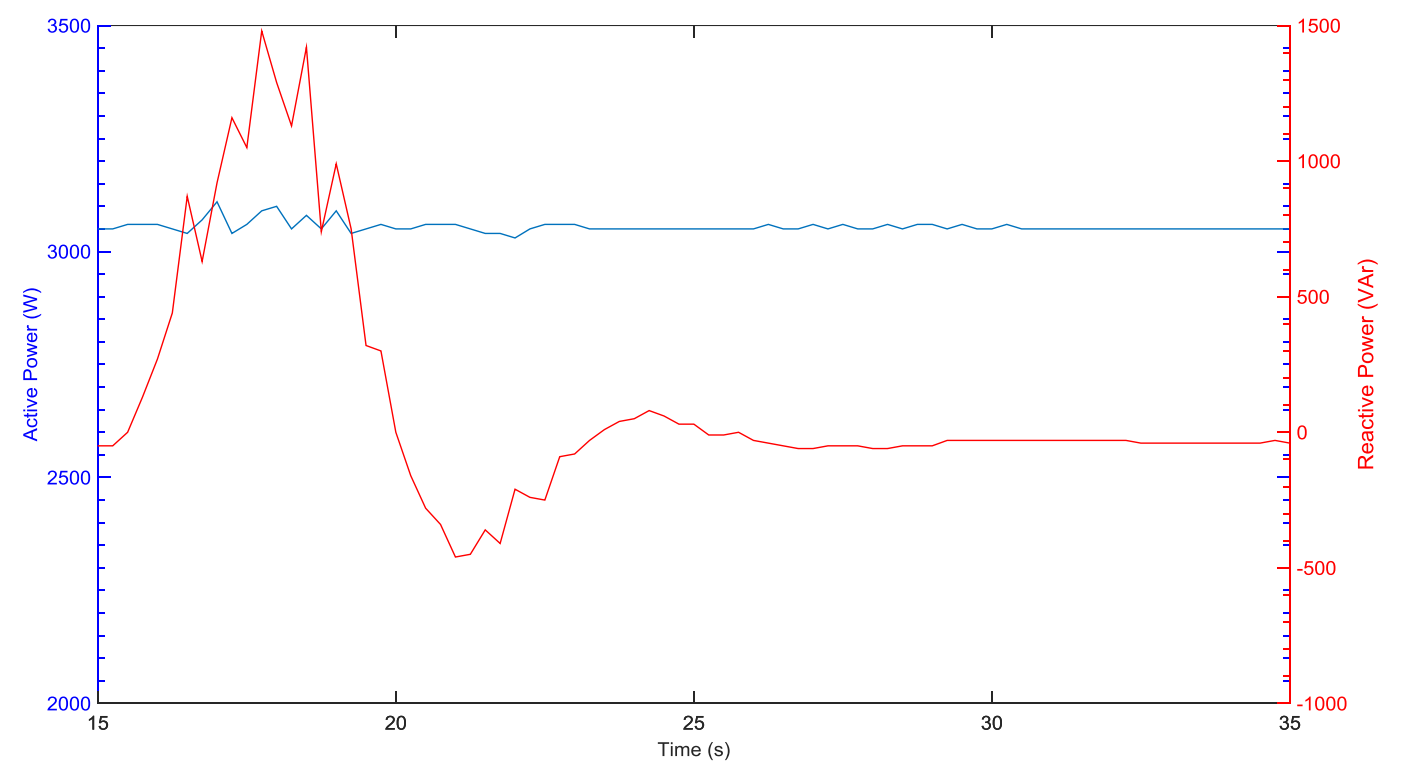
**Figure 54 Average frequency during +0.6Hz/s event**



**Figure 55 Average frequency during -0.6Hz/s event**

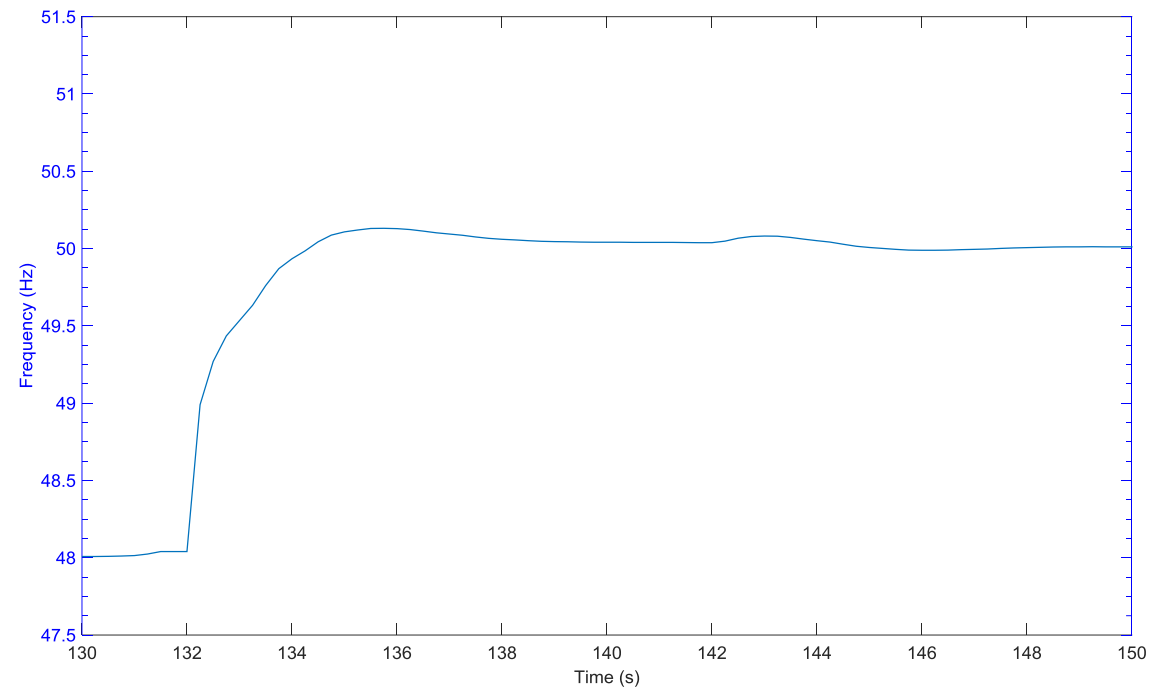


**Figure 56 ABB inverter output active and reactive powers during +0.6Hz/s event**

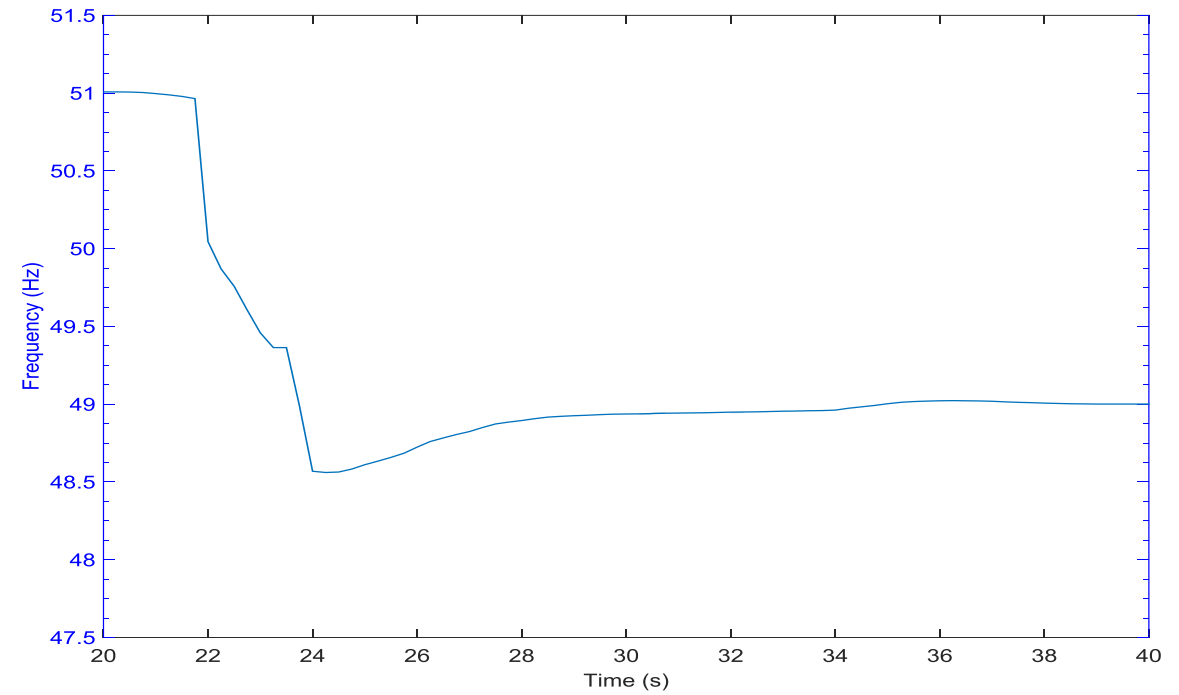


**Figure 57 ABB inverter output active and reactive powers during -0.6Hz/s event**

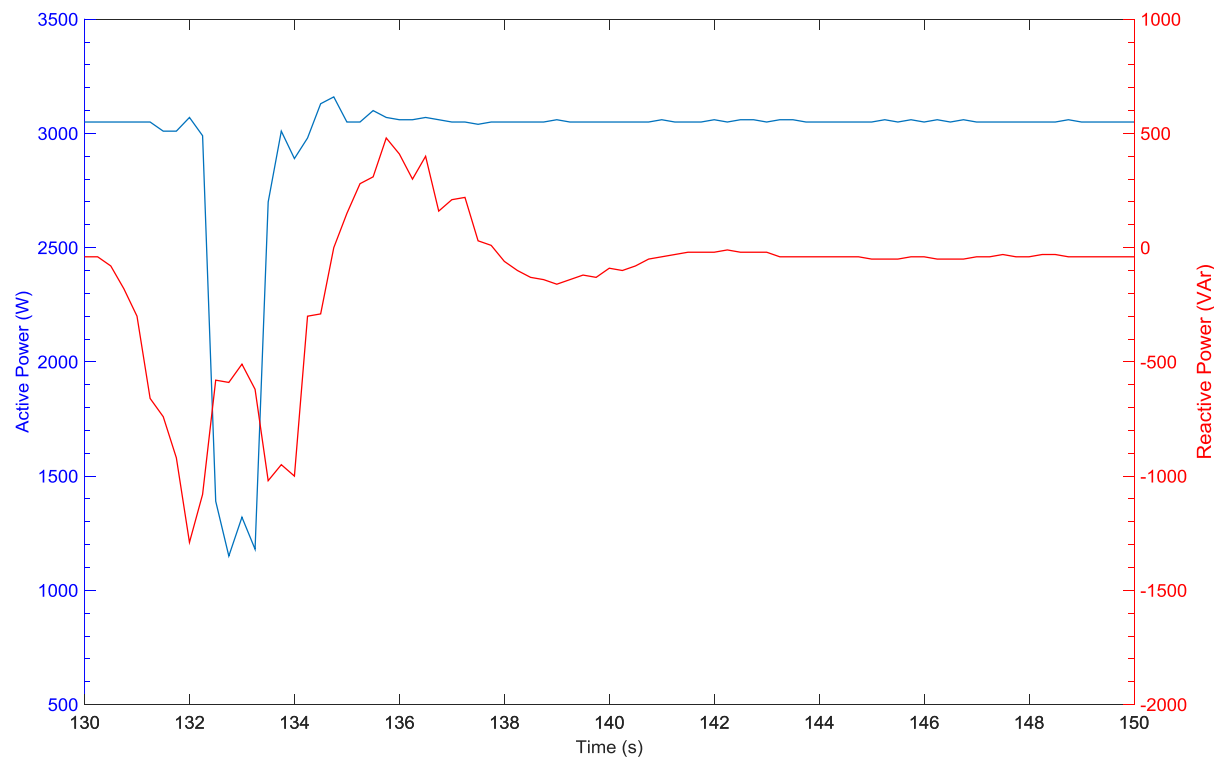
ABB inverter only connected – 0.7Hz/s event with 2Hz deviation



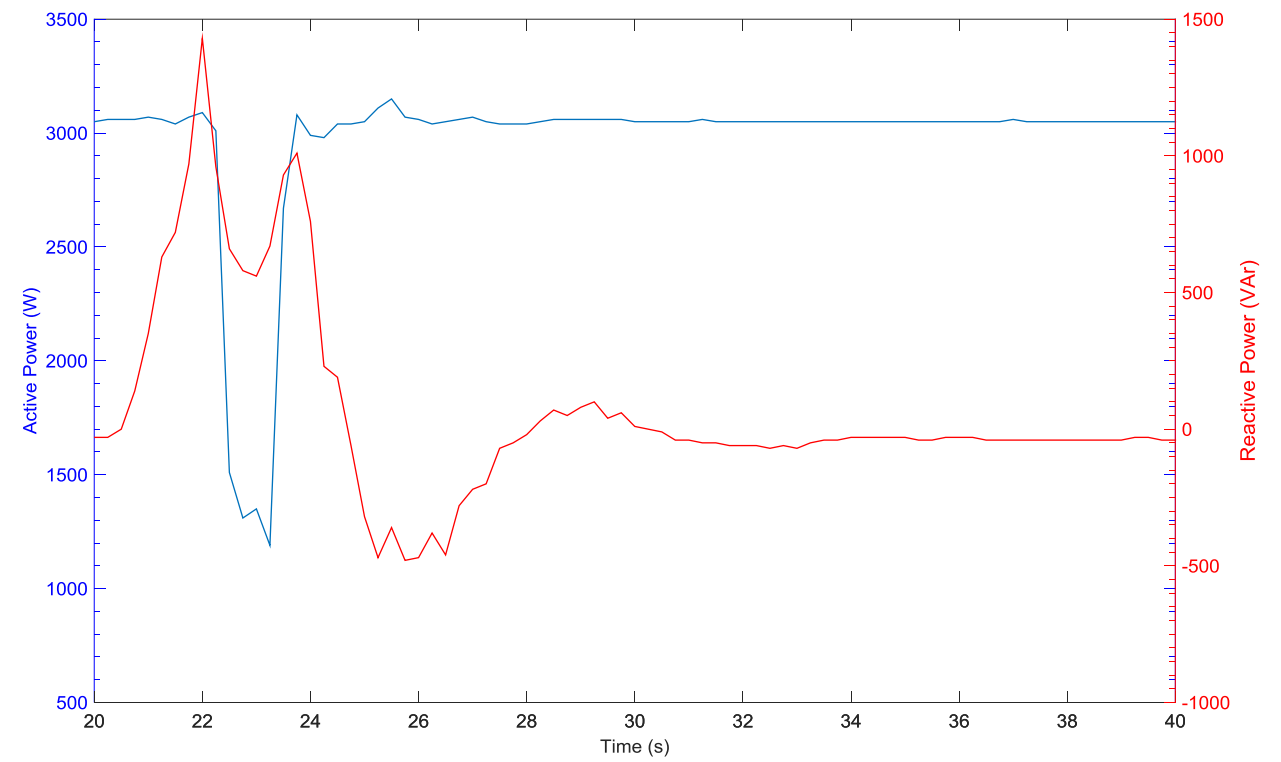
**Figure 58 Average frequency during +0.7Hz/s event with 2Hz deviation**



**Figure 59 Average frequency during -0.7Hz/s event with 2Hz deviation**



**Figure 60 ABB inverter output active and reactive powers during +0.7Hz/s event with 2Hz deviation**



**Figure 61 ABB inverter output active and reactive powers during -0.7Hz/s event with 2Hz deviation**

ABB inverter only connected – 0.7Hz/s event with 1.5Hz frequency deviation

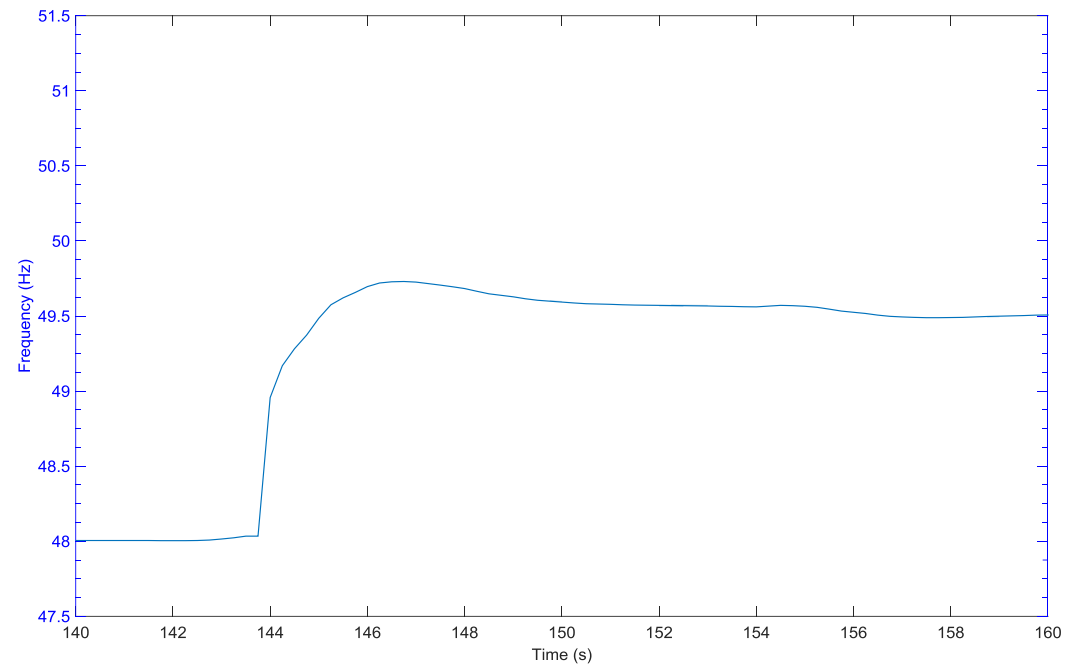


Figure 62 Average frequency during +0.7Hz/s event 1.5Hz frequency deviation

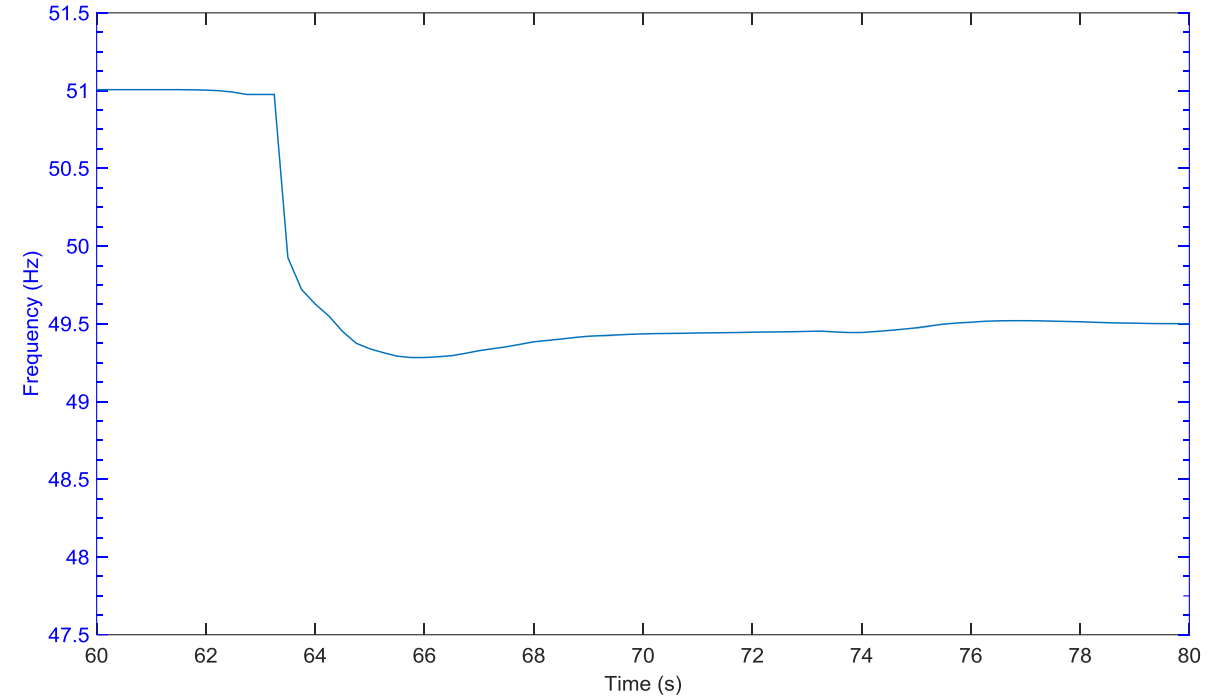


Figure 63 Average frequency during -0.7Hz/s event 1.5Hz frequency deviation

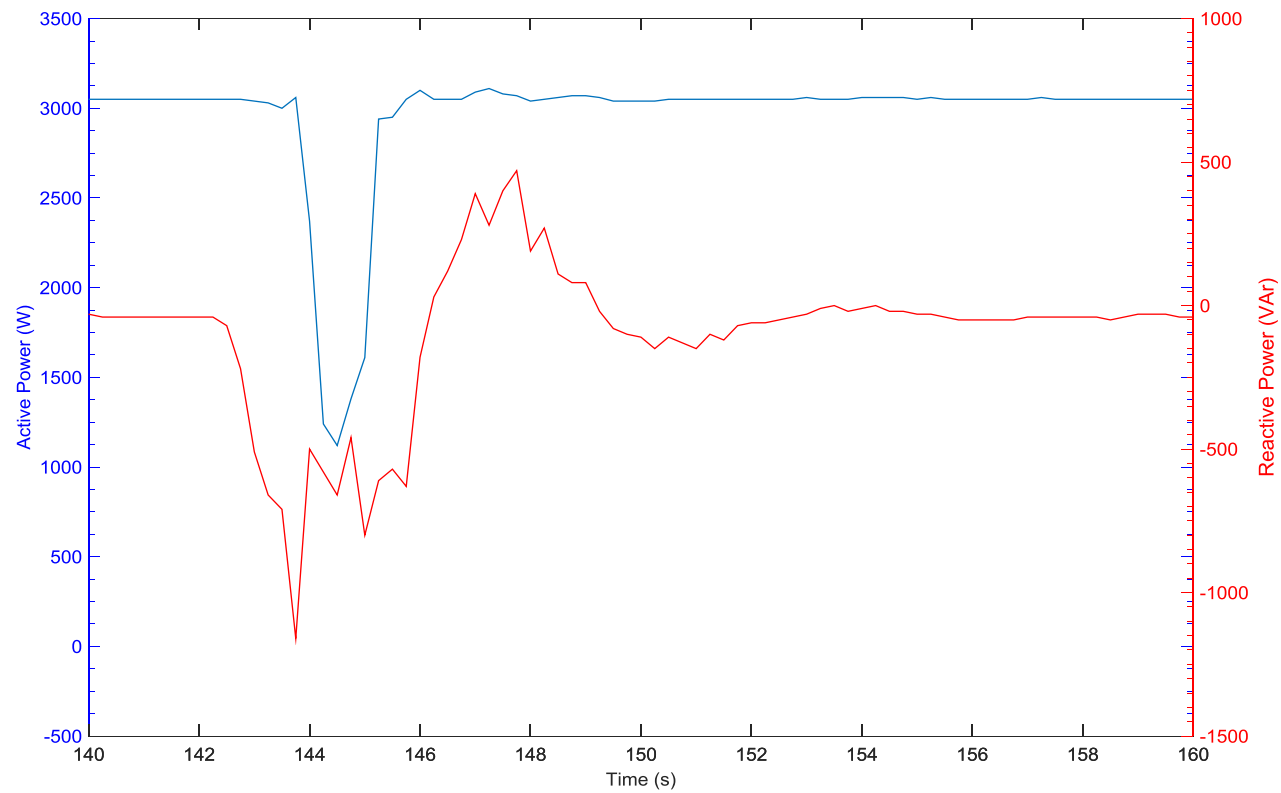


Figure 64 ABB inverter output active and reactive powers during +0.7Hz/s event 1.5Hz frequency deviation

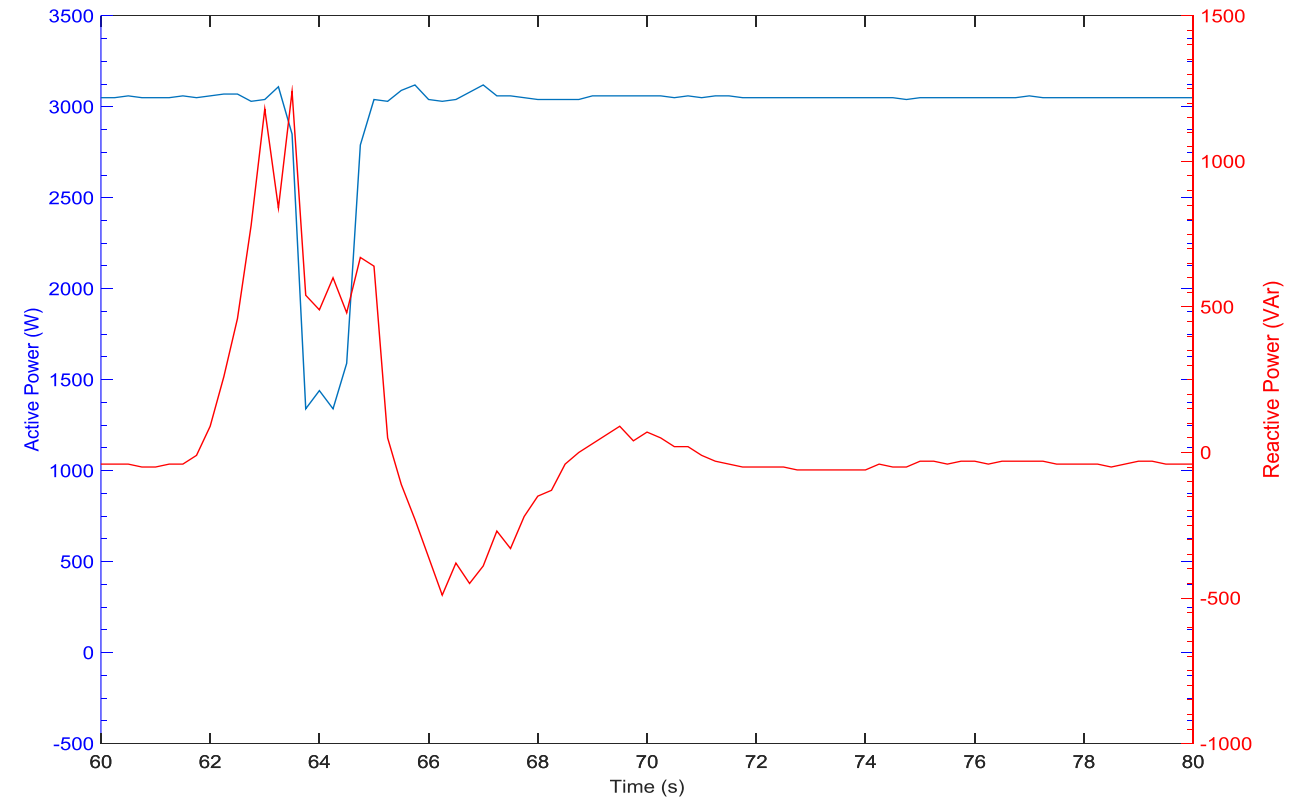


Figure 65 ABB inverter output active and reactive powers during -0.7Hz/s event 1.5Hz frequency deviation

ABB inverter only connected – 0.8Hz/s event

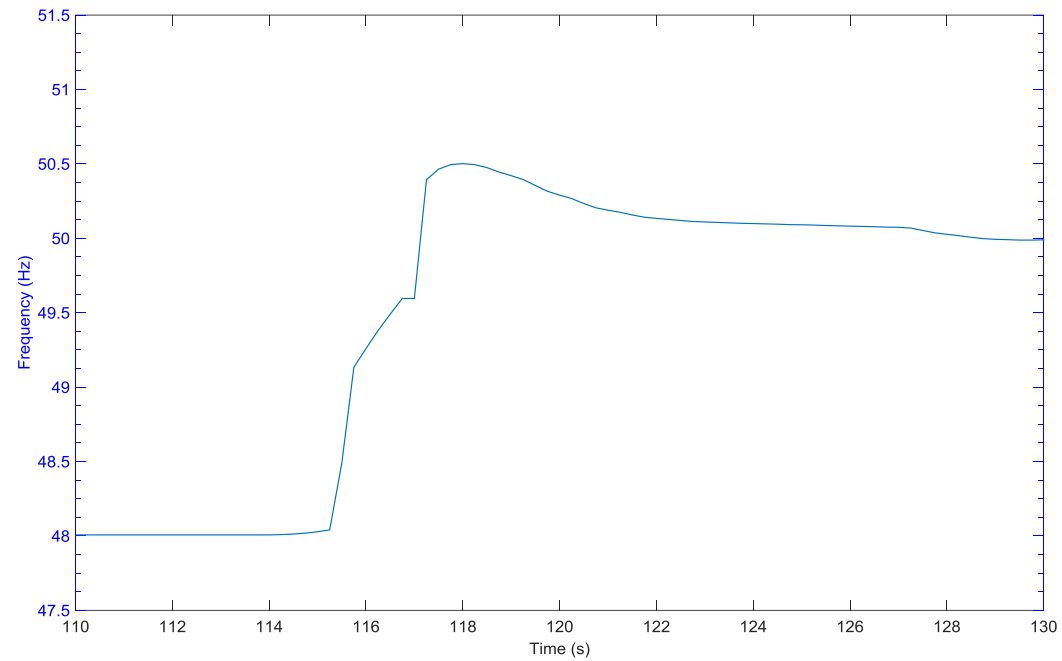


Figure 66 Average frequency during +0.8Hz/s event

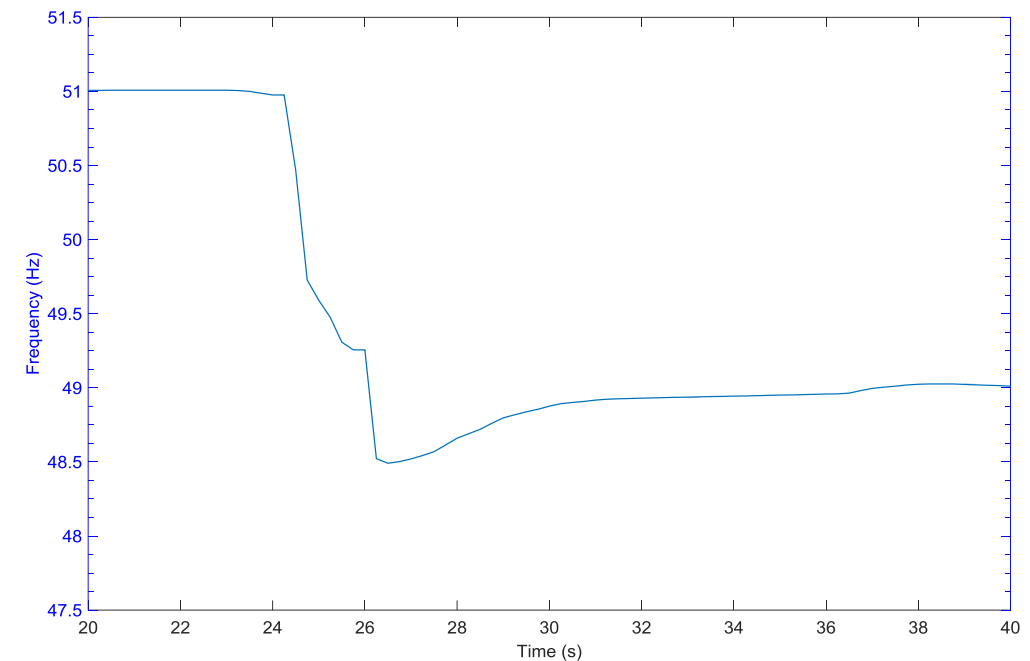


Figure 67 Average frequency during -0.8Hz/s event

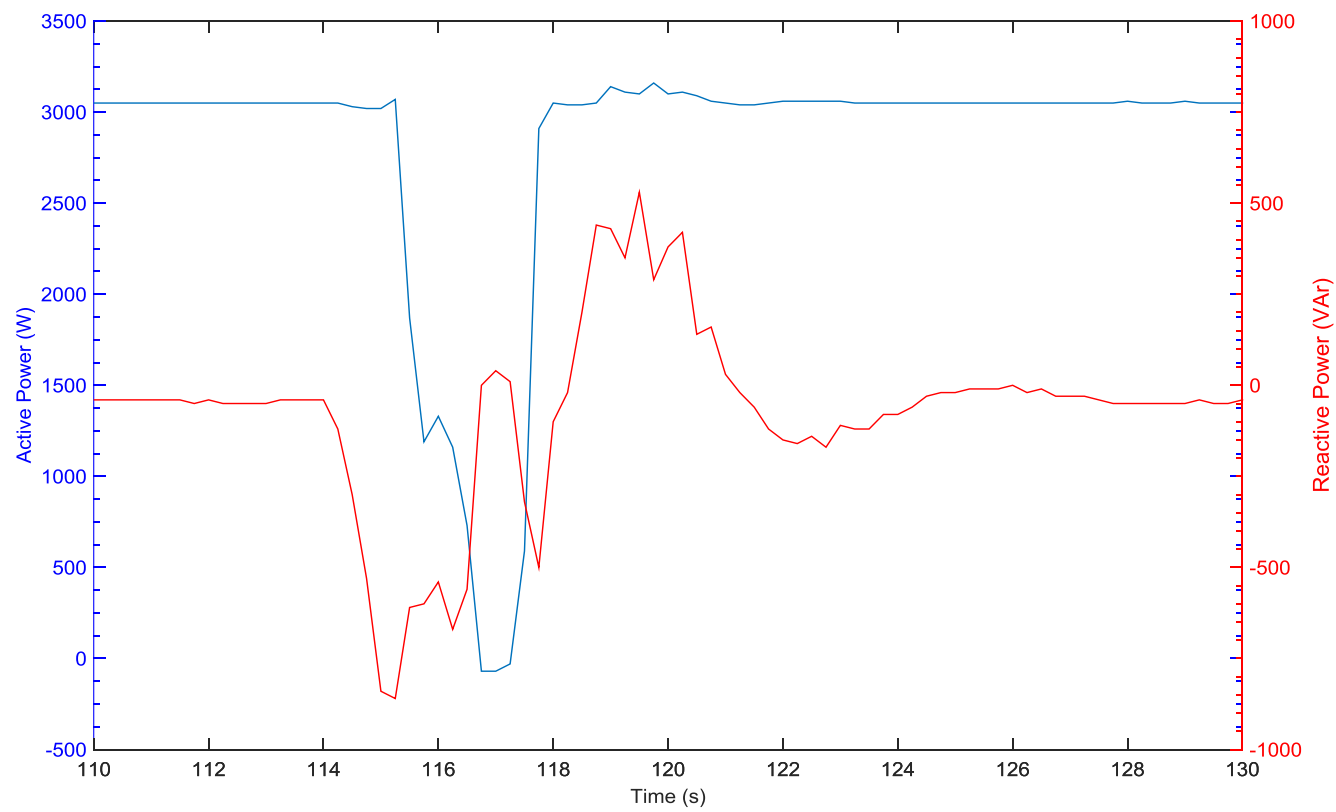


Figure 68 ABB inverter output active and reactive powers during +0.8Hz/s event

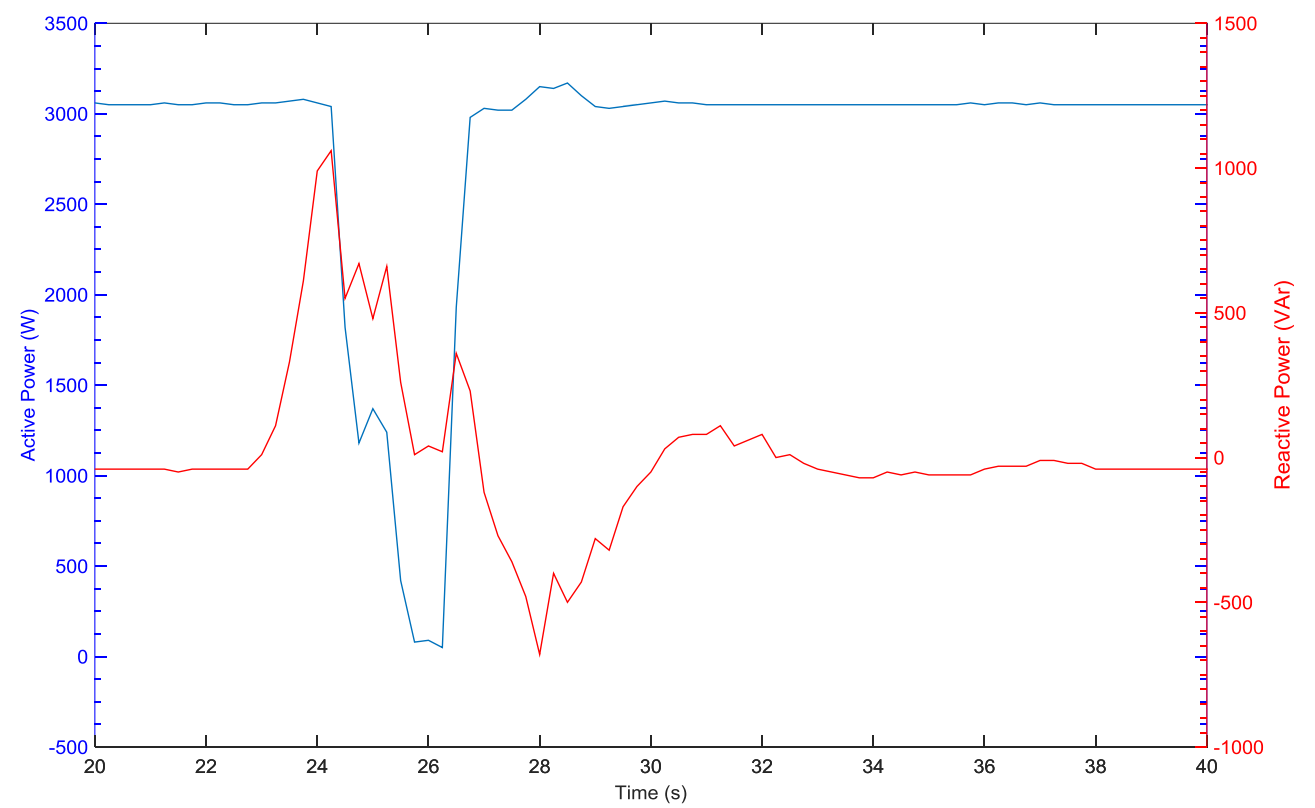
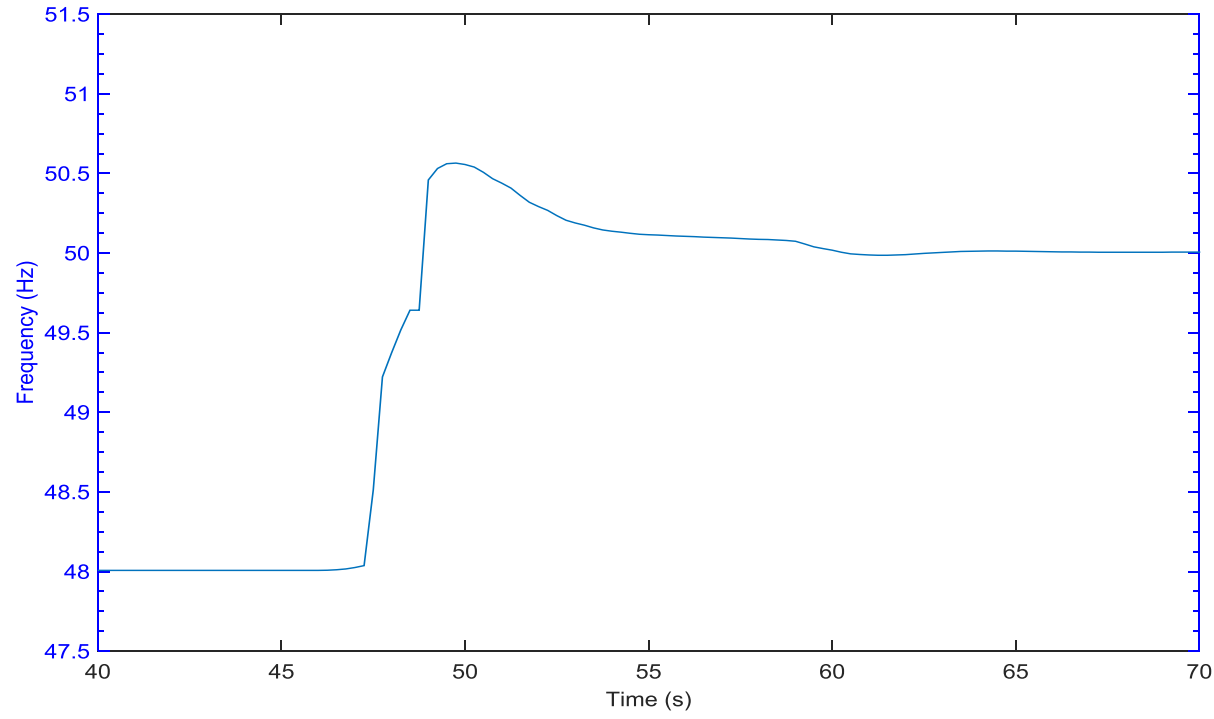


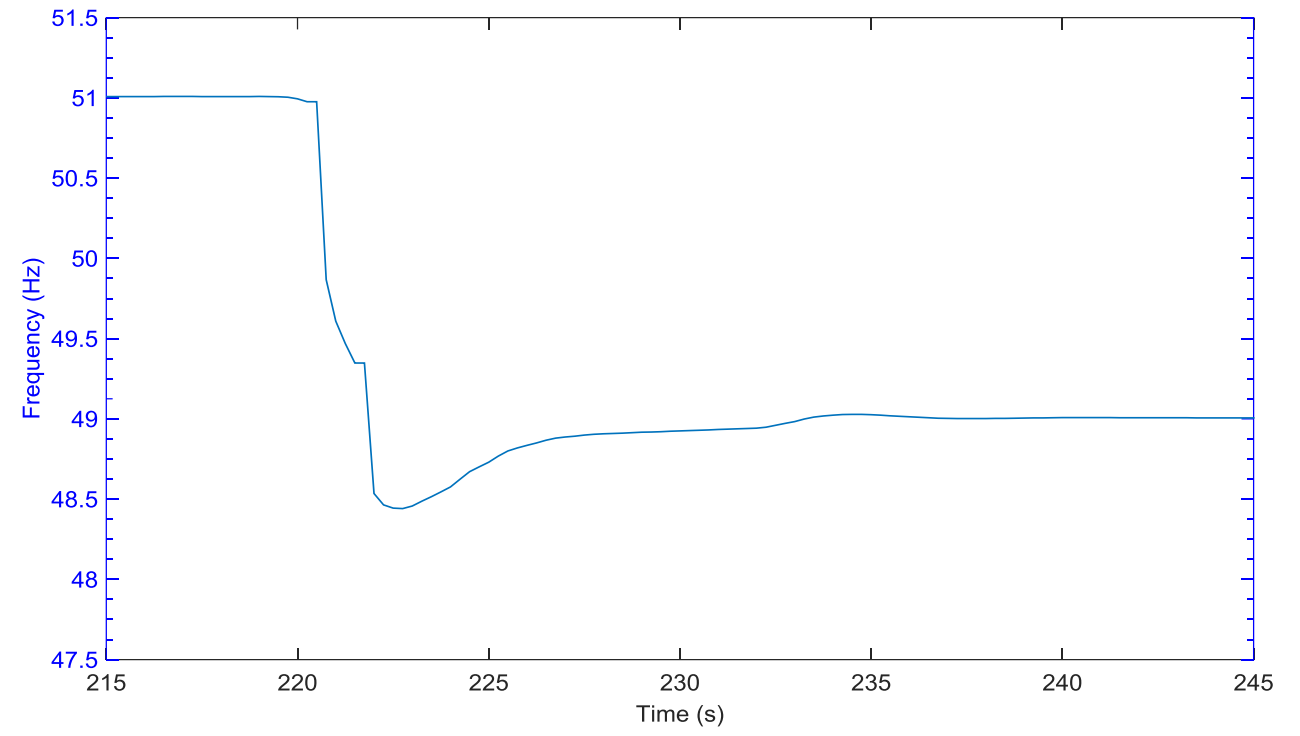
Figure 69 ABB inverter output active and reactive powers during -0.8Hz/s event



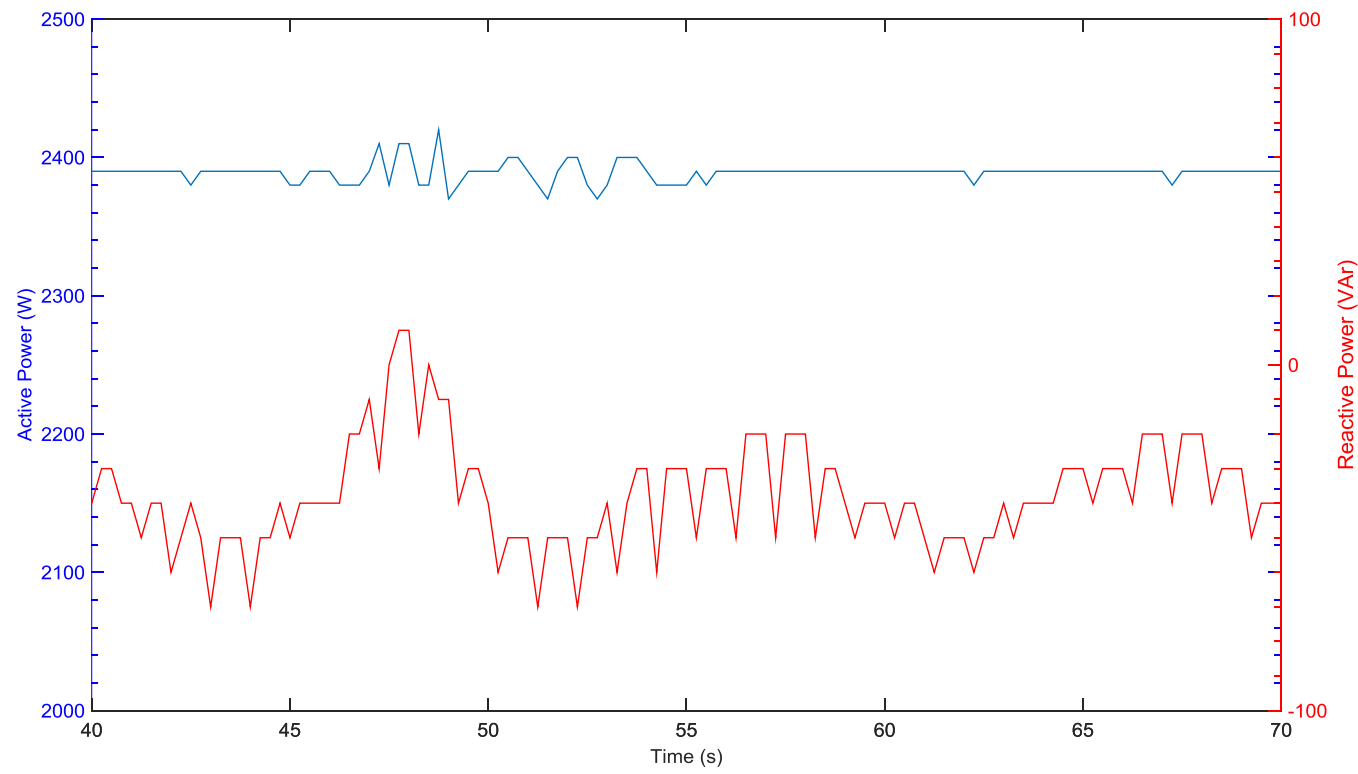
Kaco inverter only connected



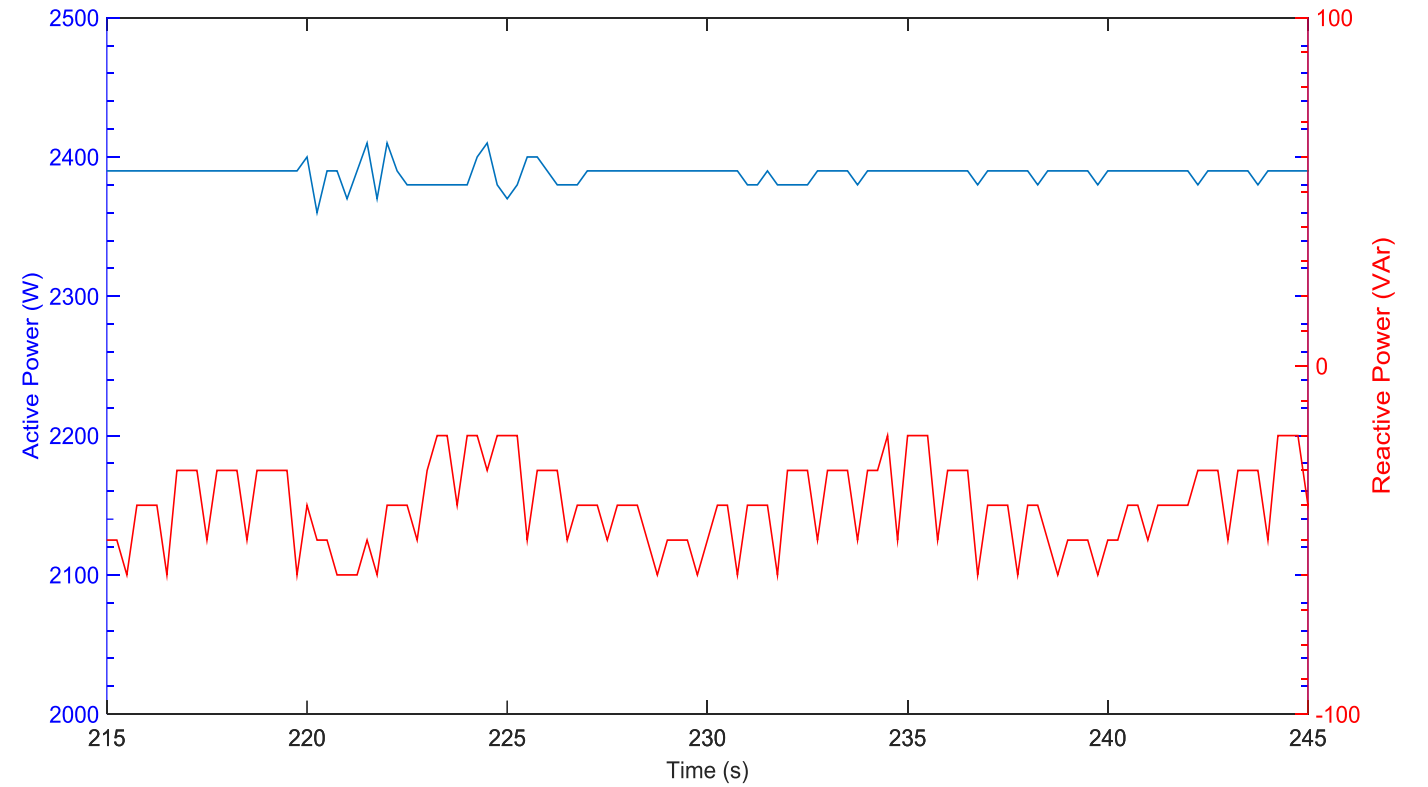
**Figure 70 Average frequency during +1Hz/s event**



**Figure 71 Average frequency during -1Hz/s event**

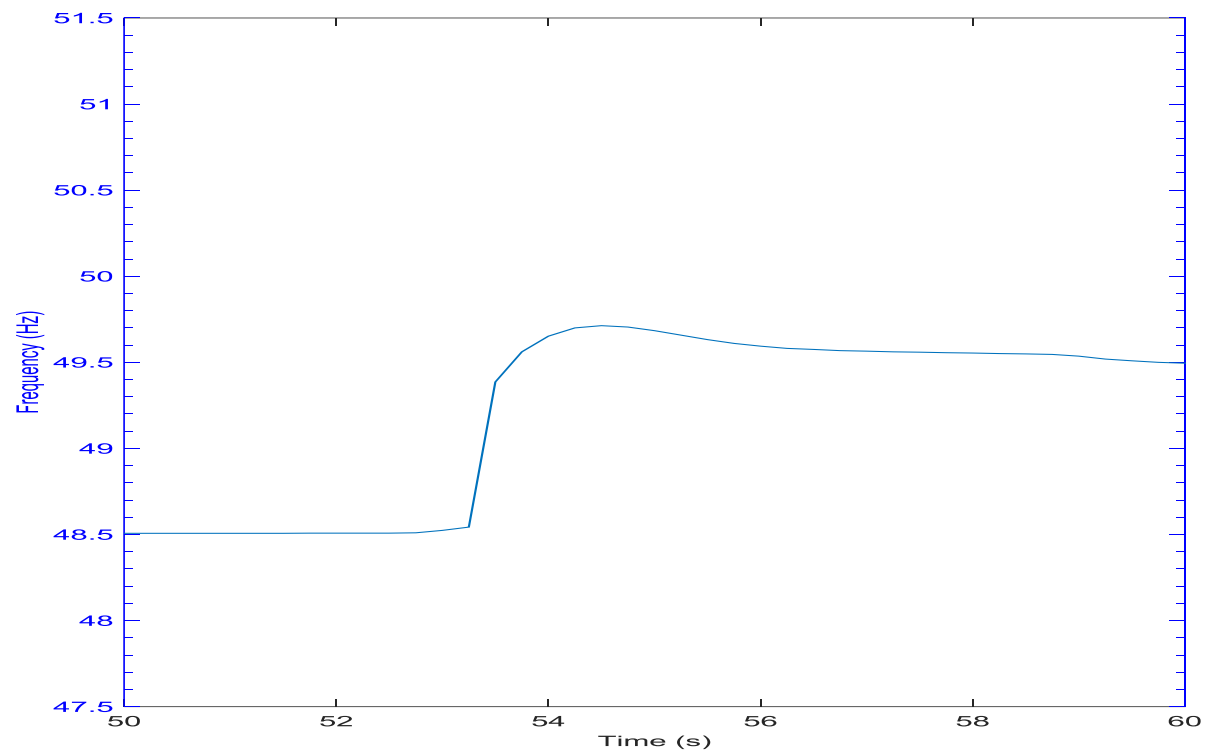


**Figure 72 Kaco inverter output active and reactive powers during +1Hz/s event**

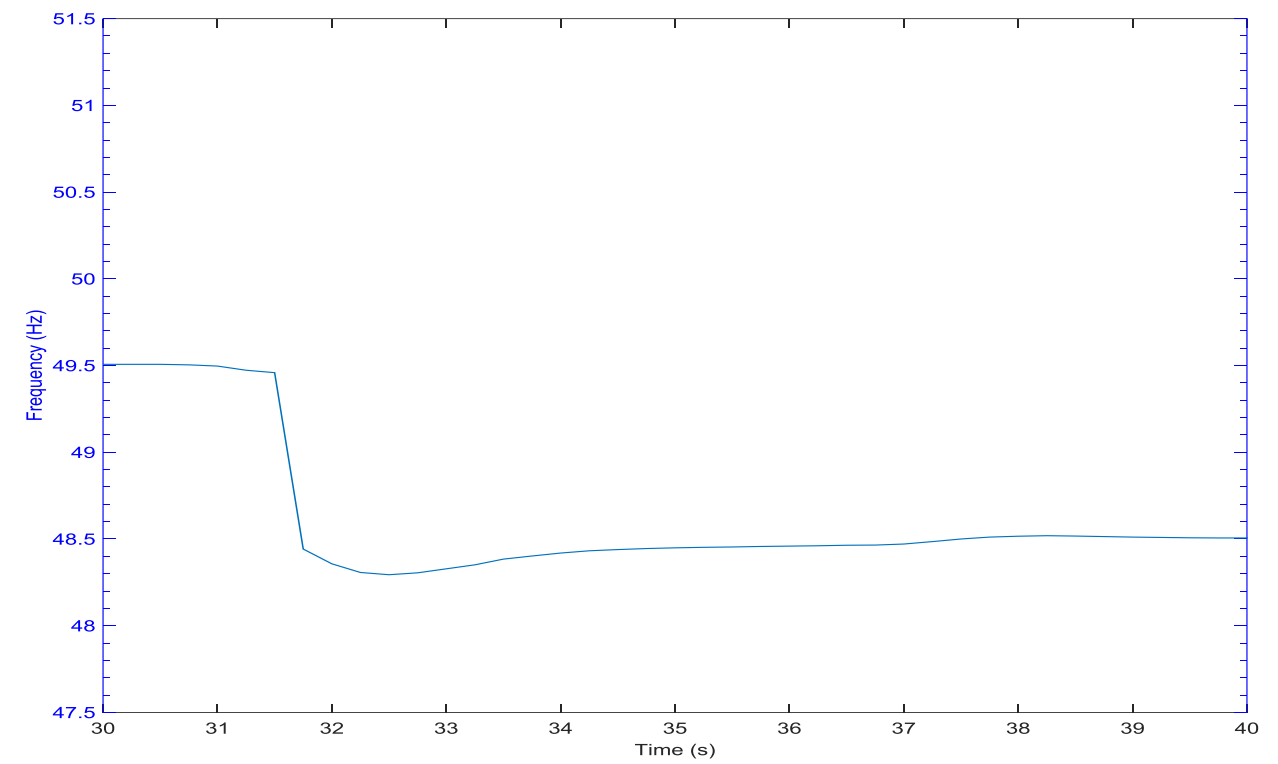


**Figure 73 Kaco inverter output active and reactive powers during -1Hz/s event**

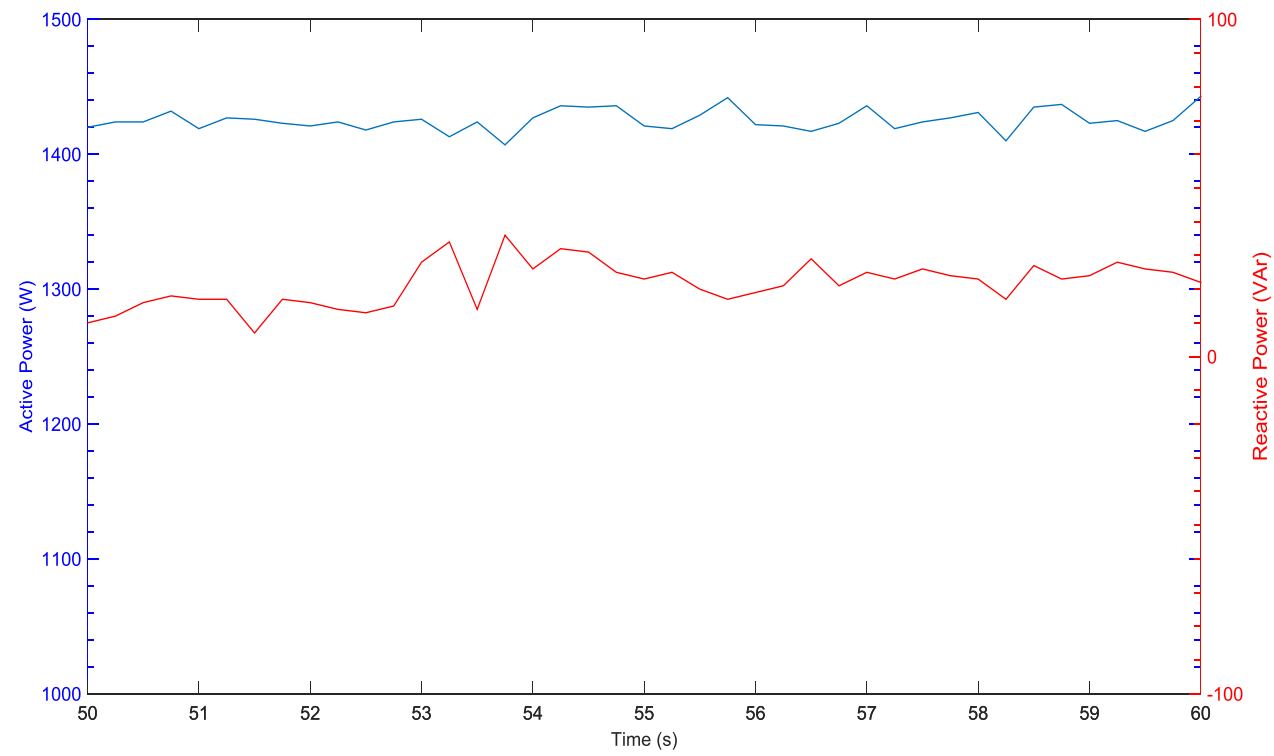
Fronius inverter only connected



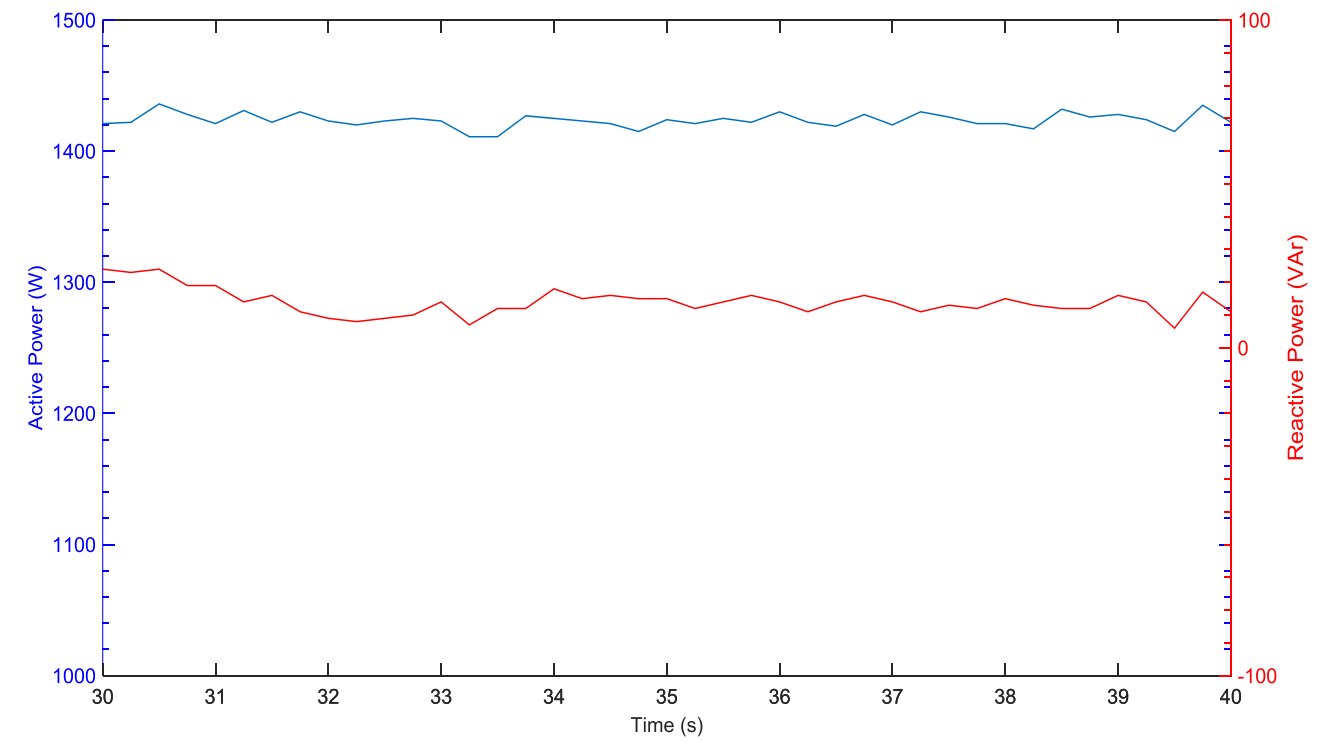
**Figure 74 Average frequency during +1Hz/s event**



**Figure 75 Average frequency during -1Hz/s event**



**Figure 76 Fronius inverter output active and reactive powers during +1Hz/s event**



**Figure 77 Fronius inverter output active and reactive powers during -1Hz/s event**

SMA single phase inverter only connected

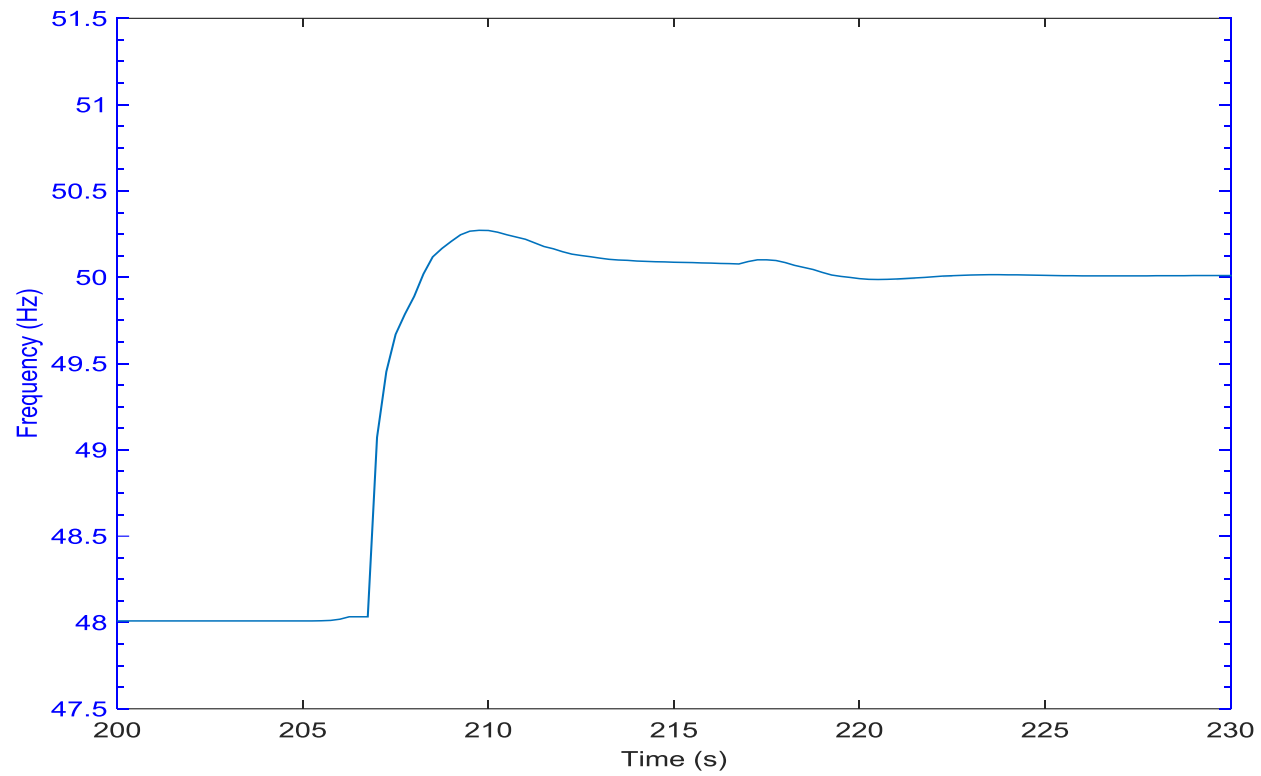


Figure 78 Average frequency during +1Hz/s event

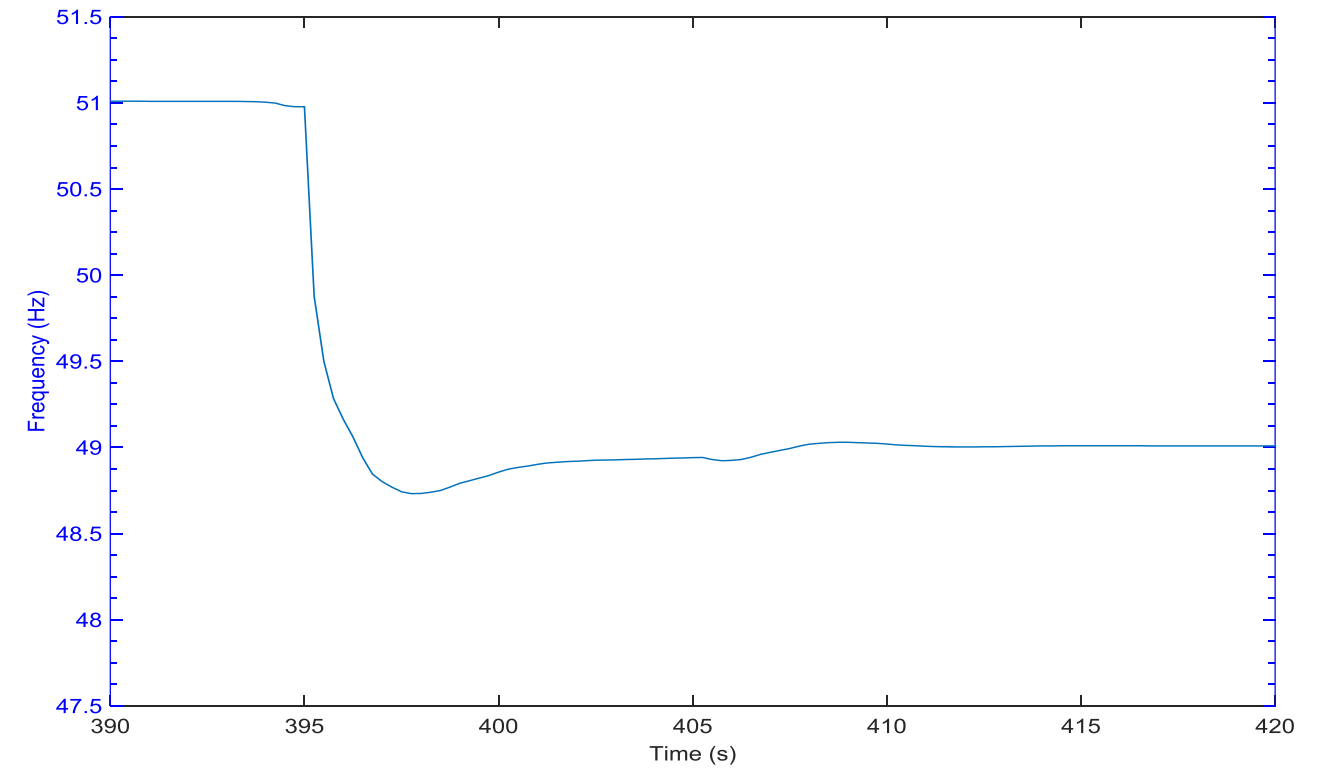


Figure 79 Average frequency during -1Hz/s event

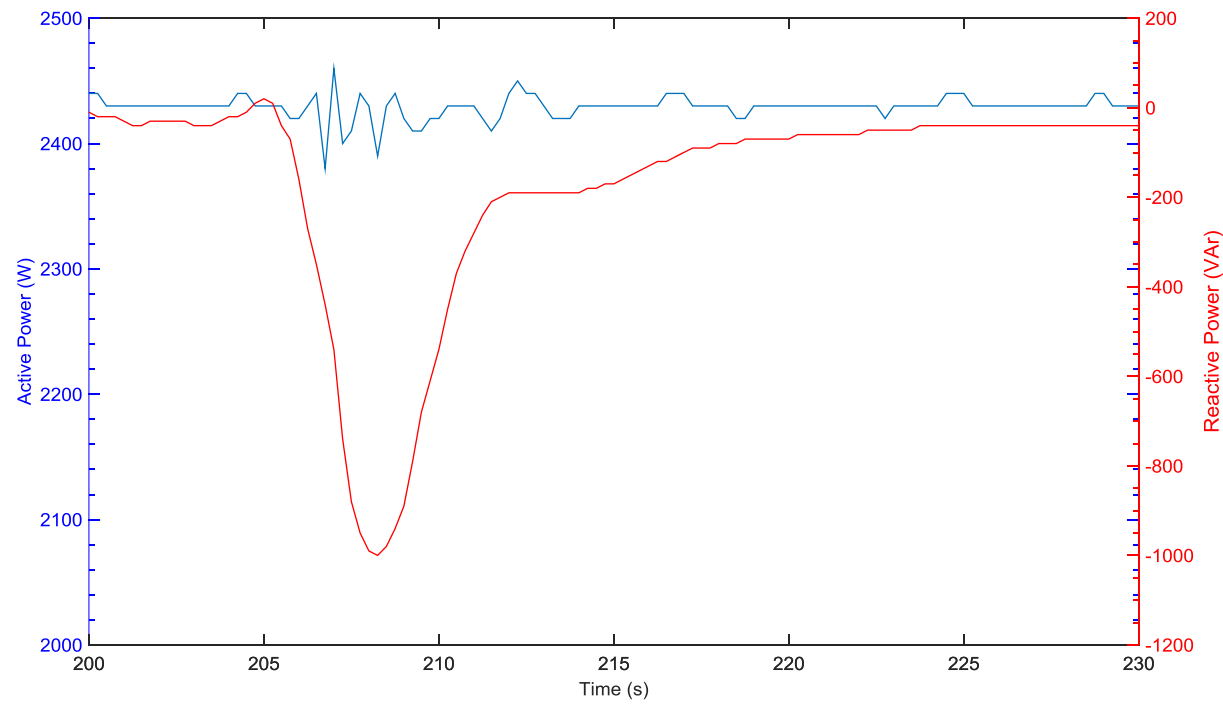


Figure 80 SMA inverter output active and reactive powers during +1Hz/s event

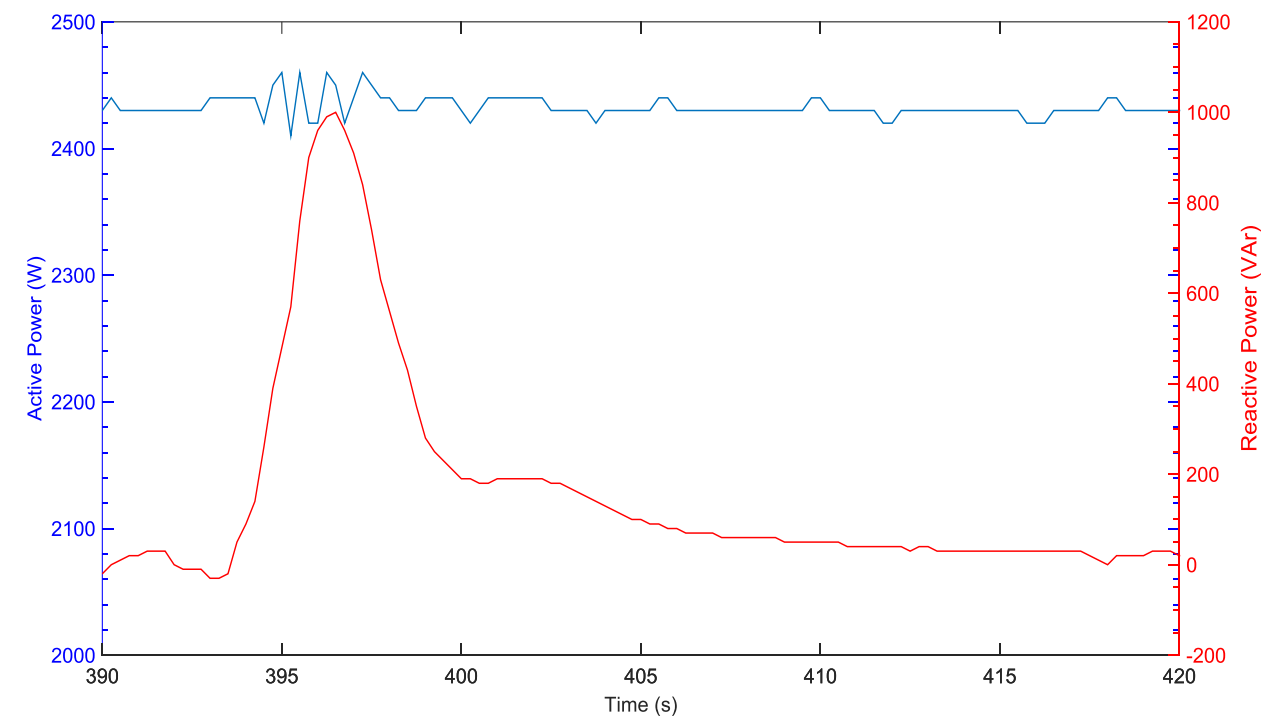
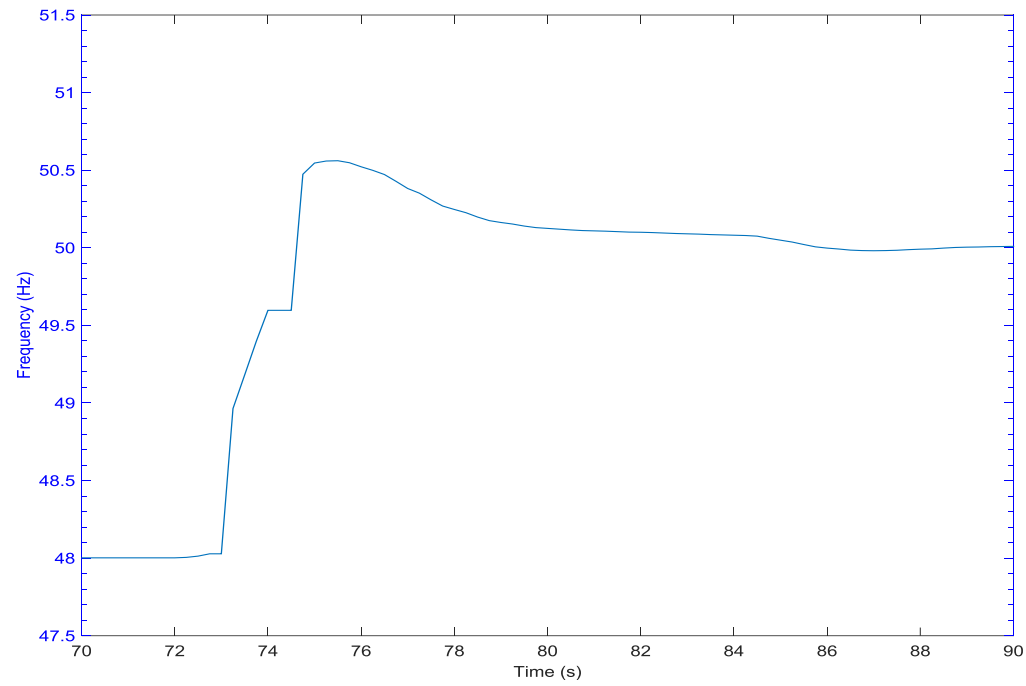
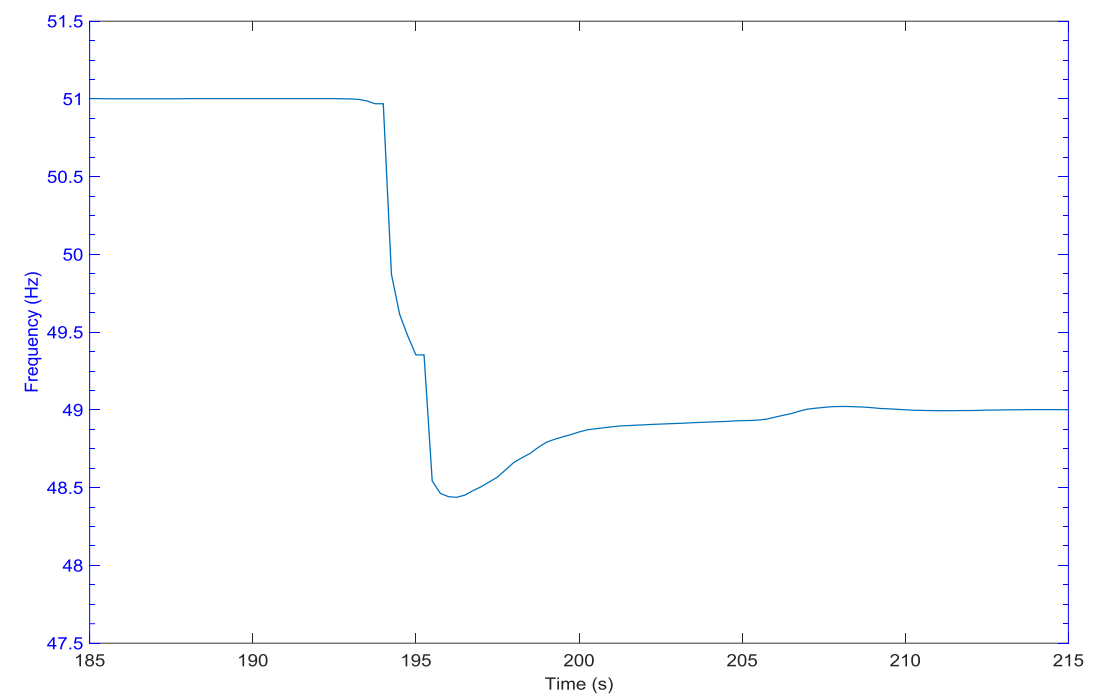


Figure 81 SMA inverter output active and reactive powers during -1Hz/s event

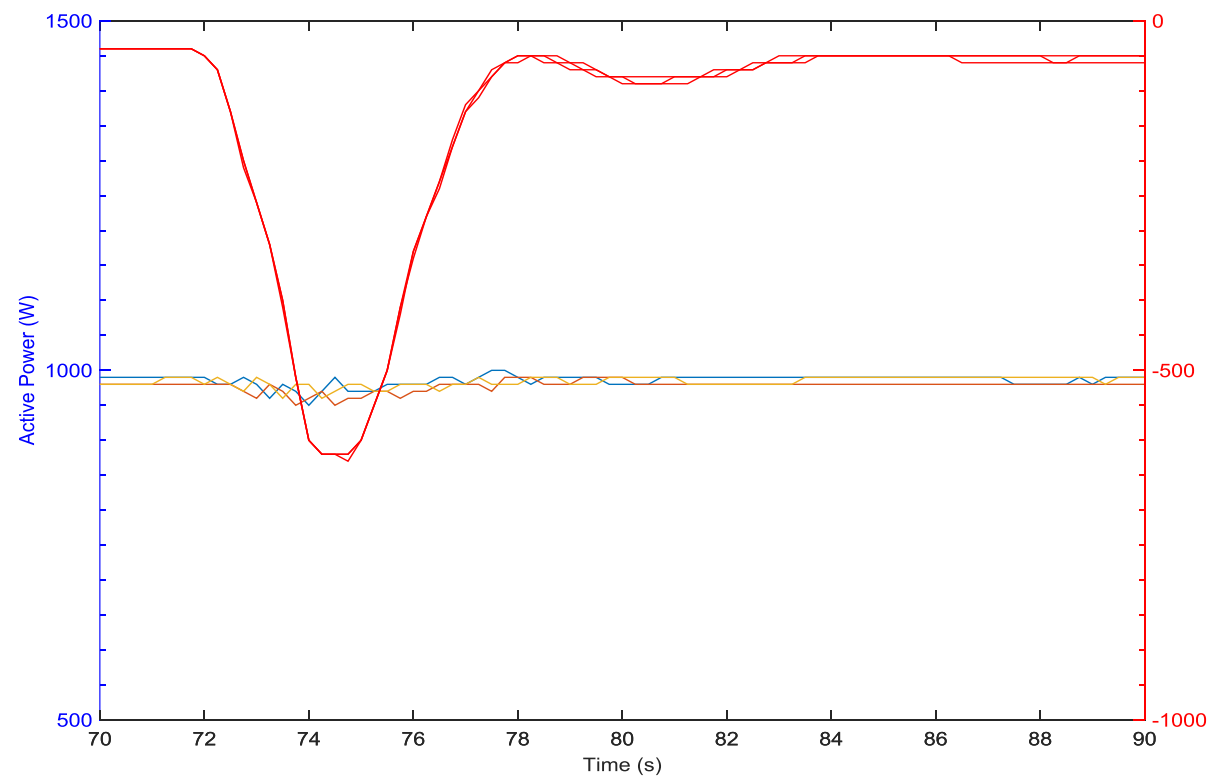
SMA three phase inverter only connected



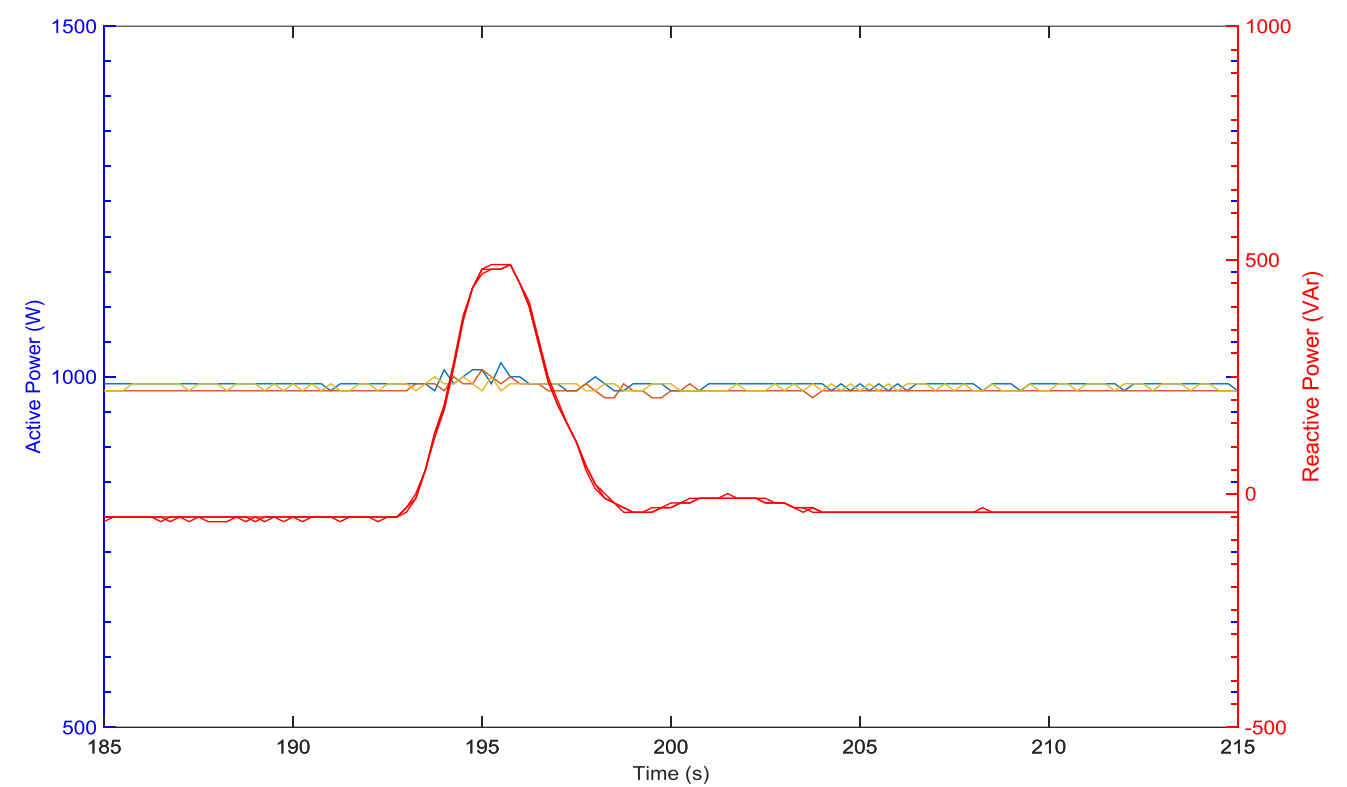
**Figure 82 Average frequency during +1Hz/s event**



**Figure 83 Average frequency during -1Hz/s event**

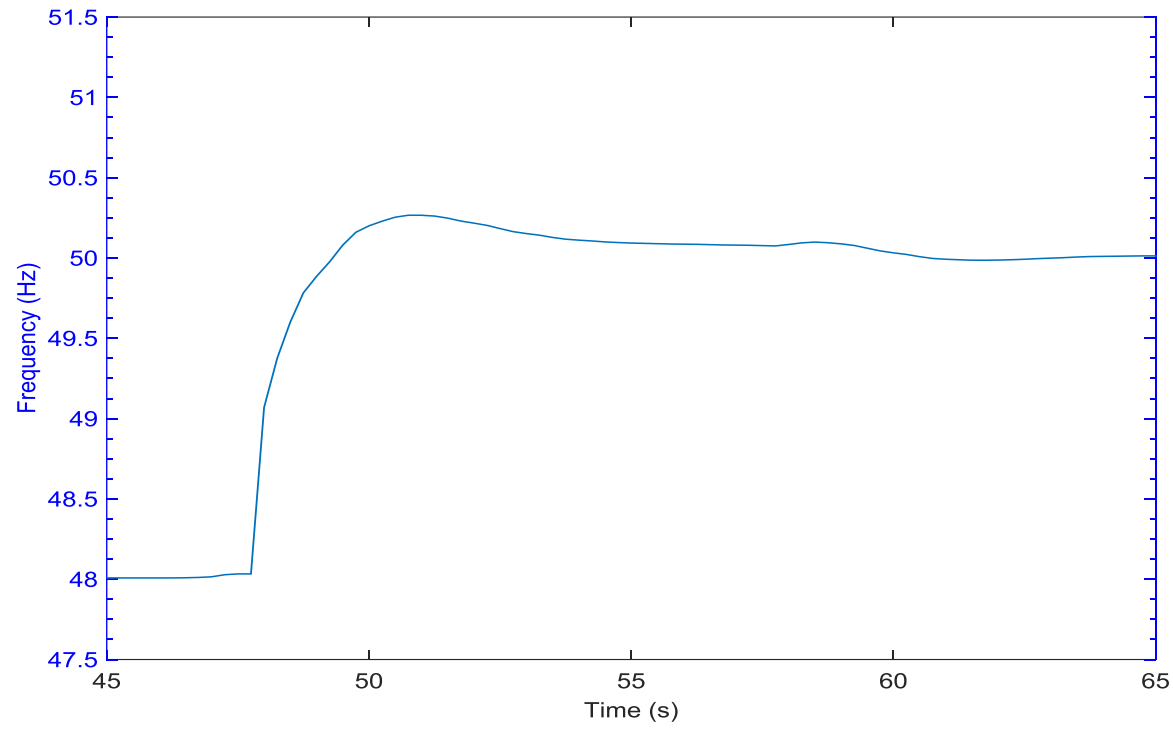


**Figure 84 SMA inverter output active and reactive powers during +1Hz/s event**

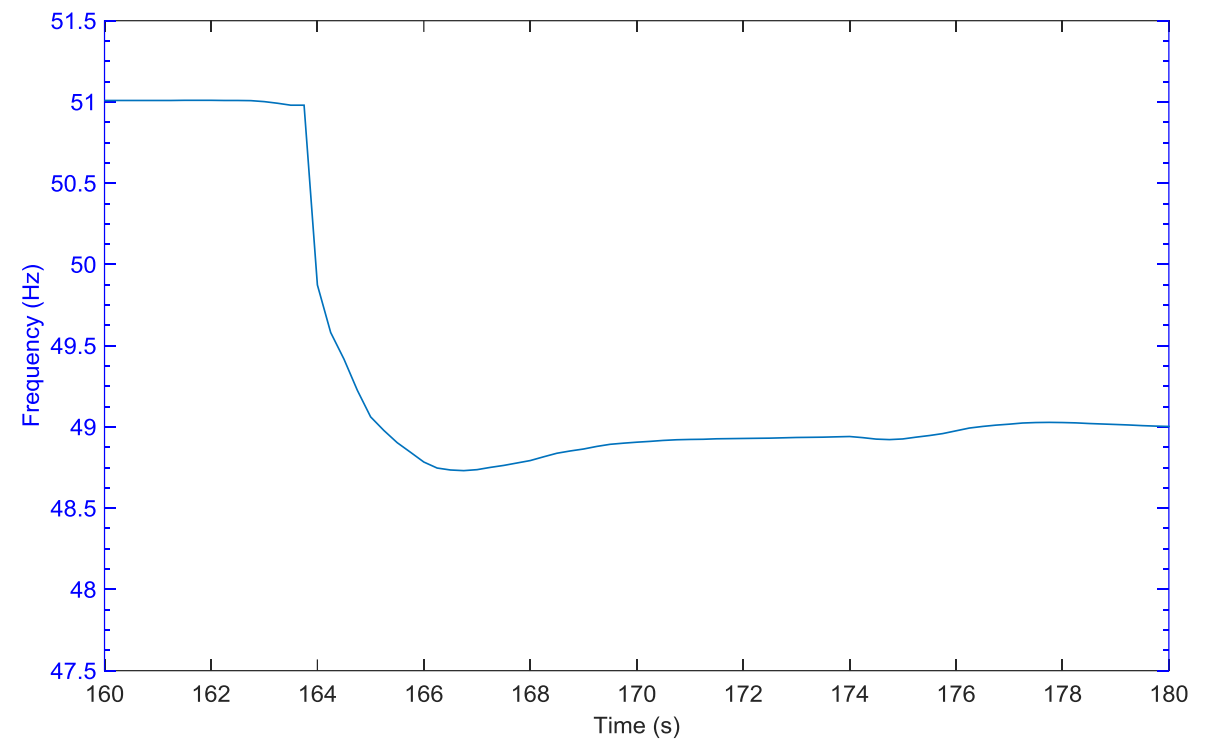


**Figure 85 SMA inverter output active and reactive powers during -1Hz/s event**

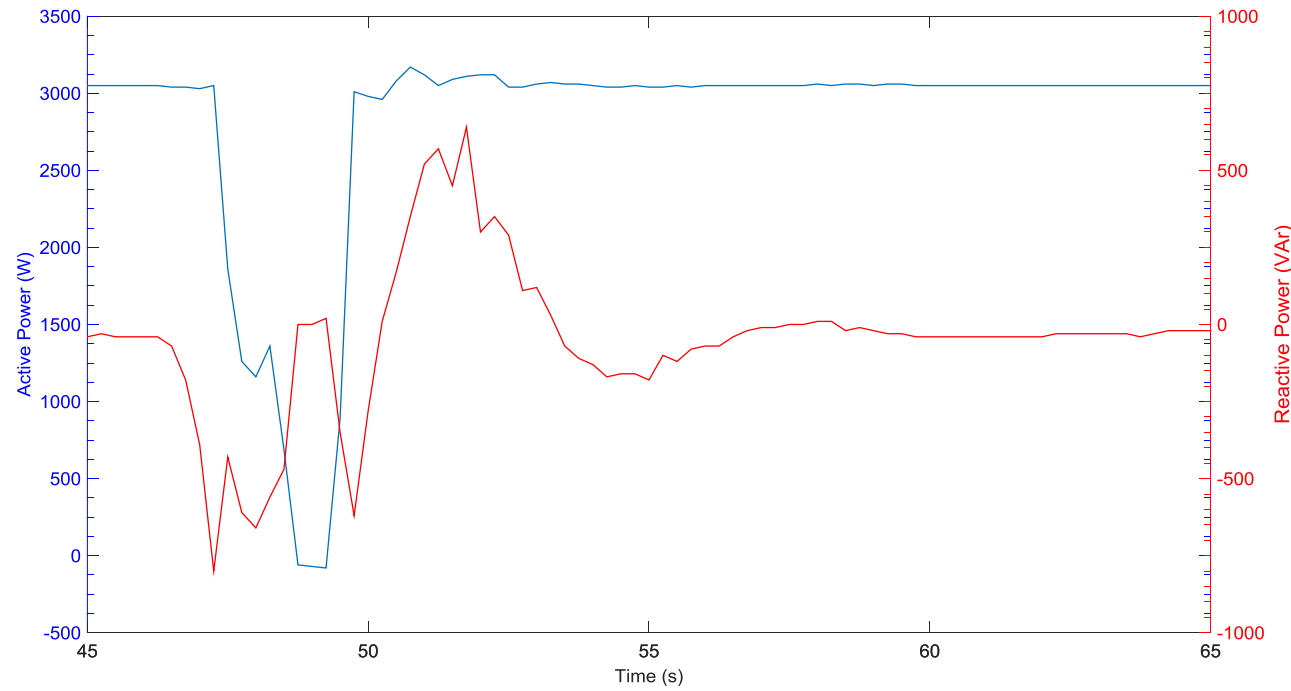
ABB and SMA inverters connected simultaneously



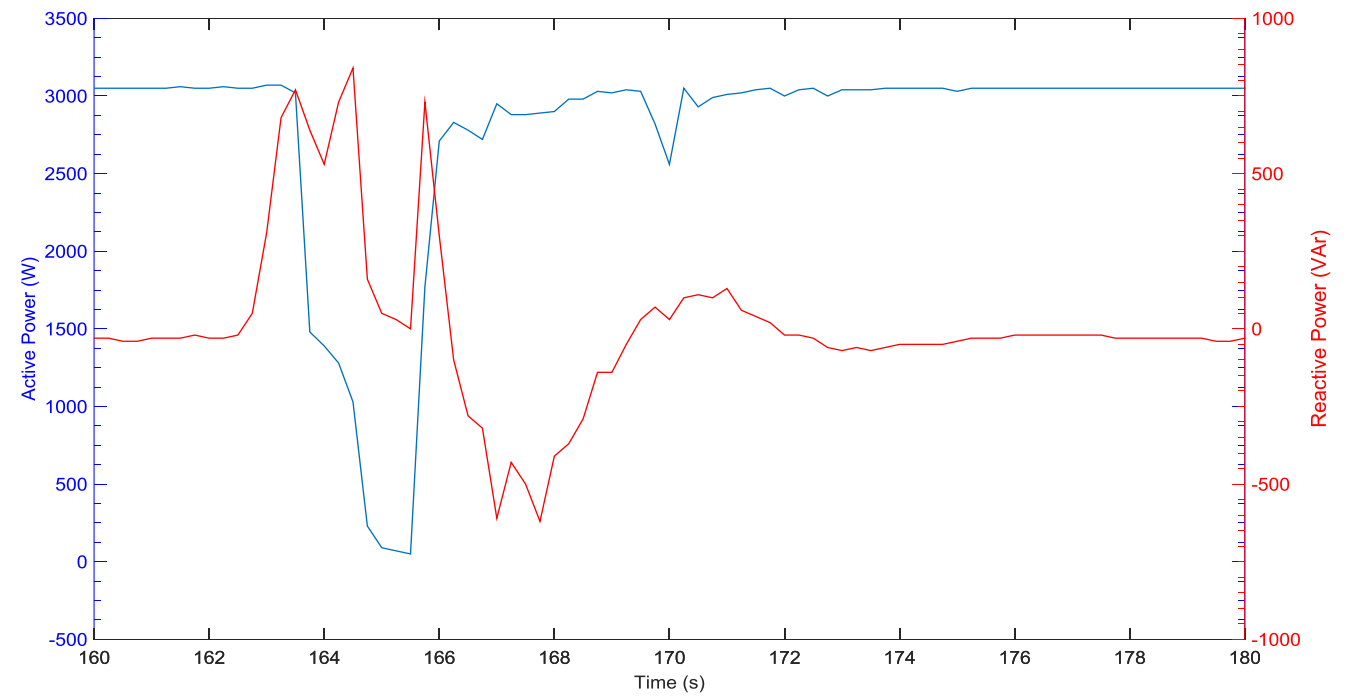
**Figure 86 Average frequency during +1Hz/s event**



**Figure 87 Average frequency during -1Hz/s event**



**Figure 88 ABB inverter output active and reactive powers during +1Hz/s event**



**Figure 89 ABB inverter output active and reactive powers during -1Hz/s event**

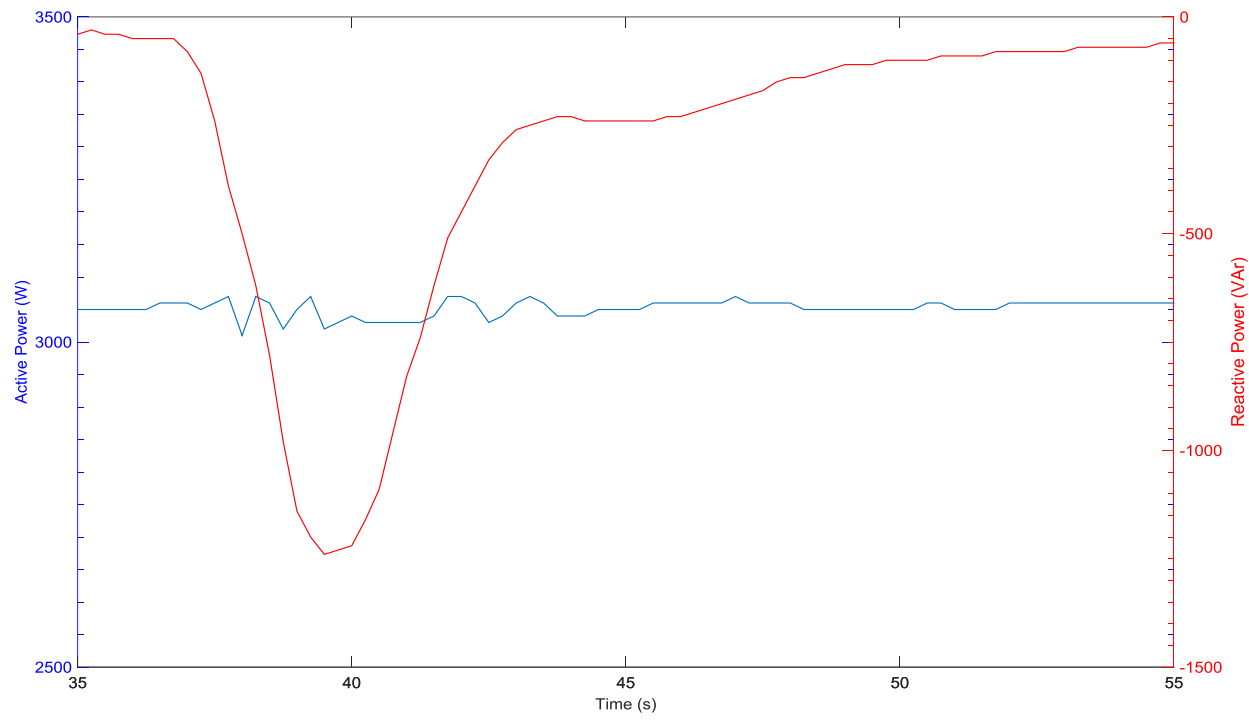


Figure 90 SMA inverter output active and reactive powers during +1Hz/s event

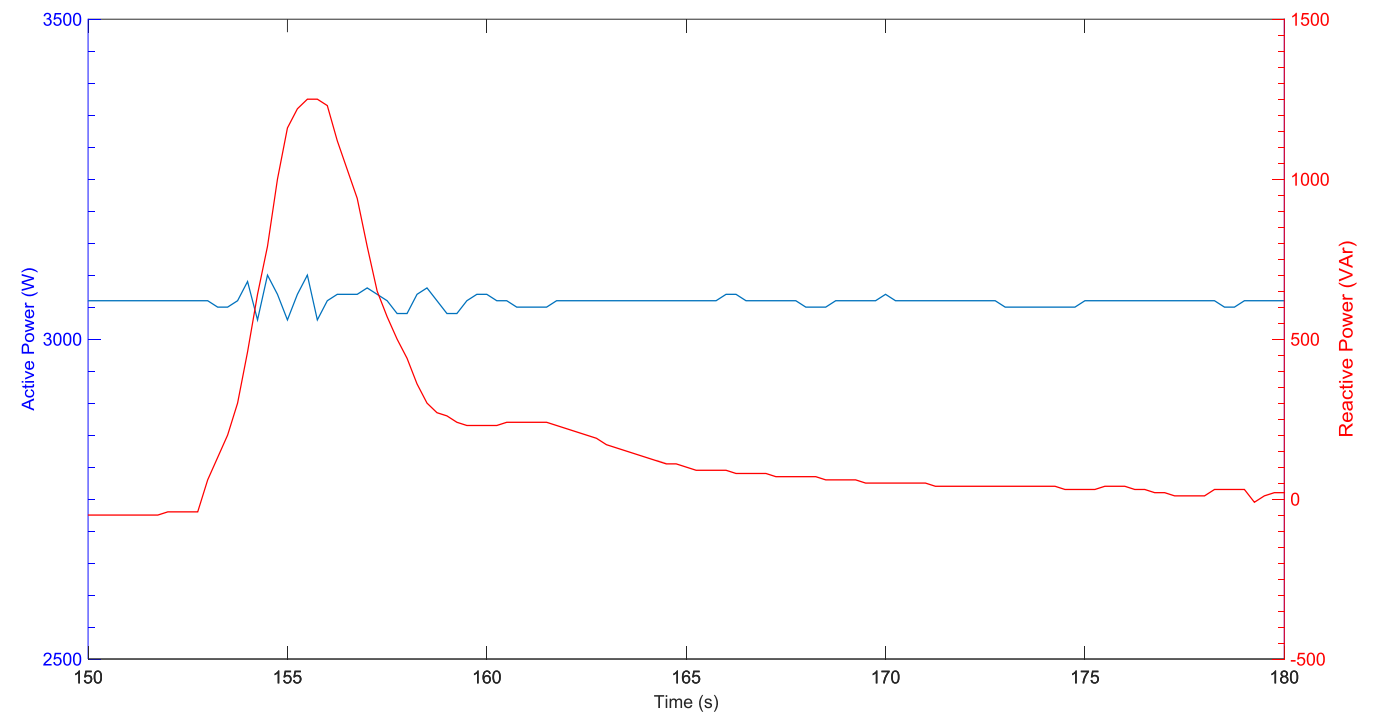


Figure 91 SMA inverter output active and reactive powers during -1Hz/s event

ABB and KACO inverters connected simultaneously

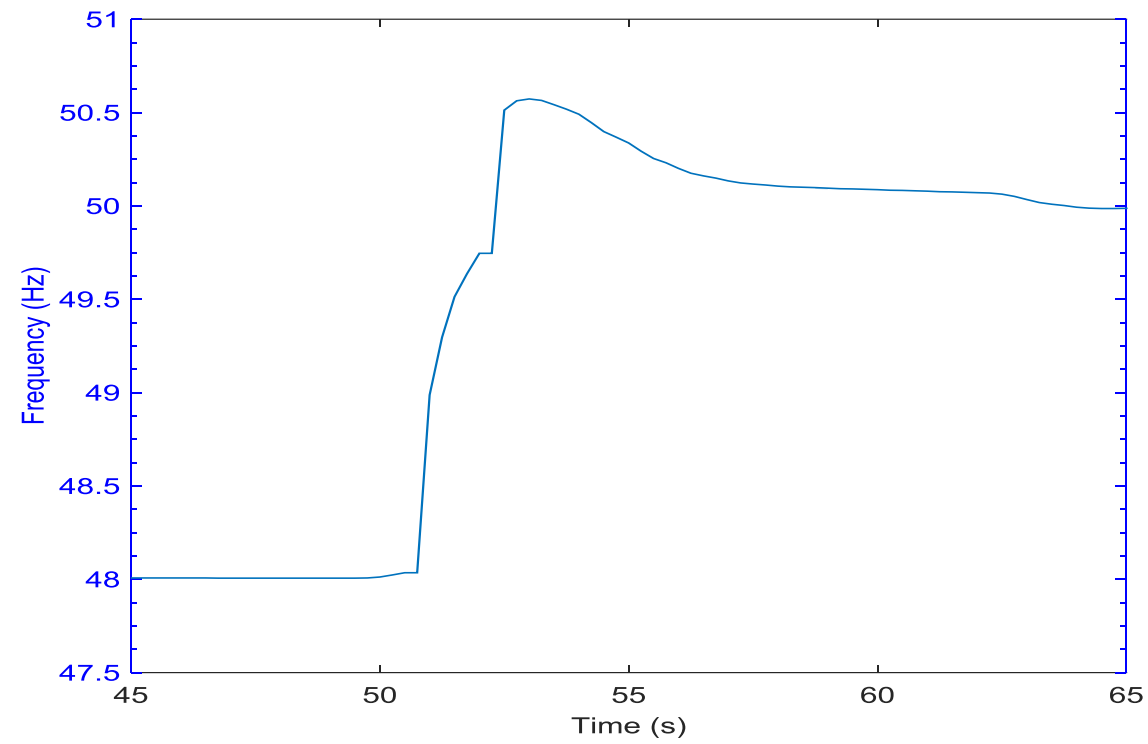


Figure 92 Average frequency during +1Hz/s event

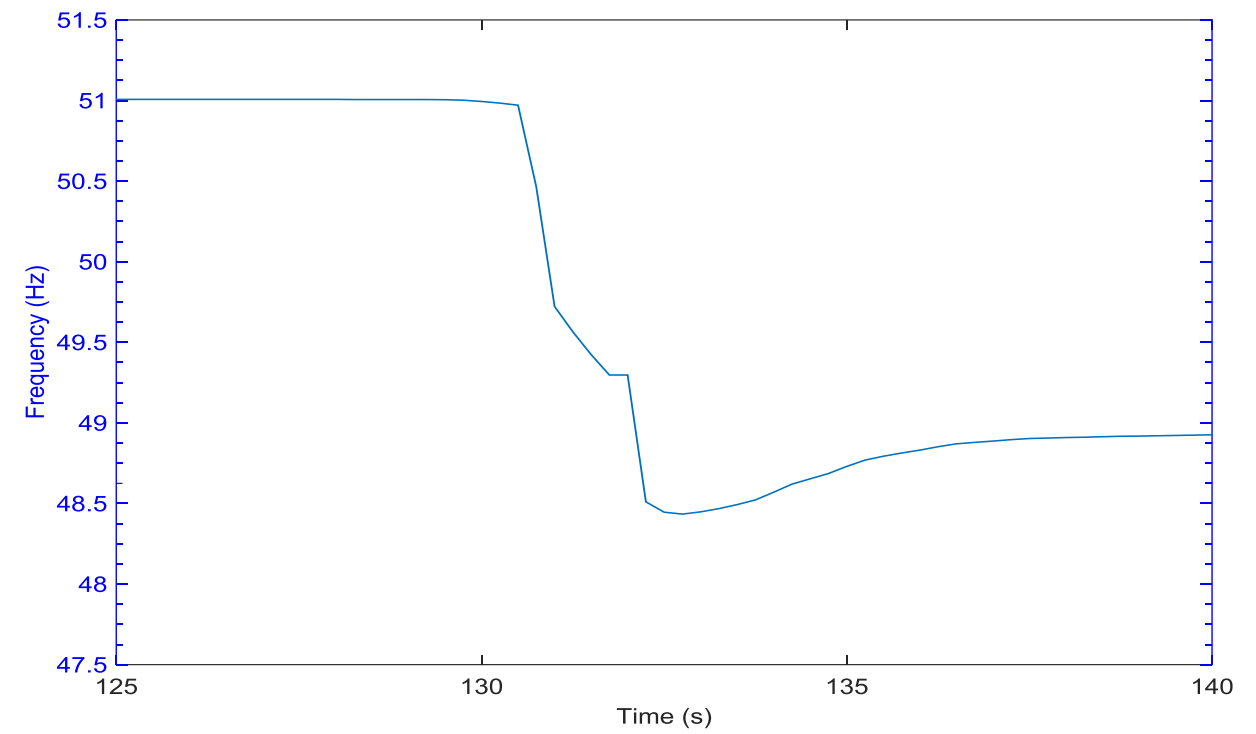


Figure 93 Average frequency during -1Hz/s event

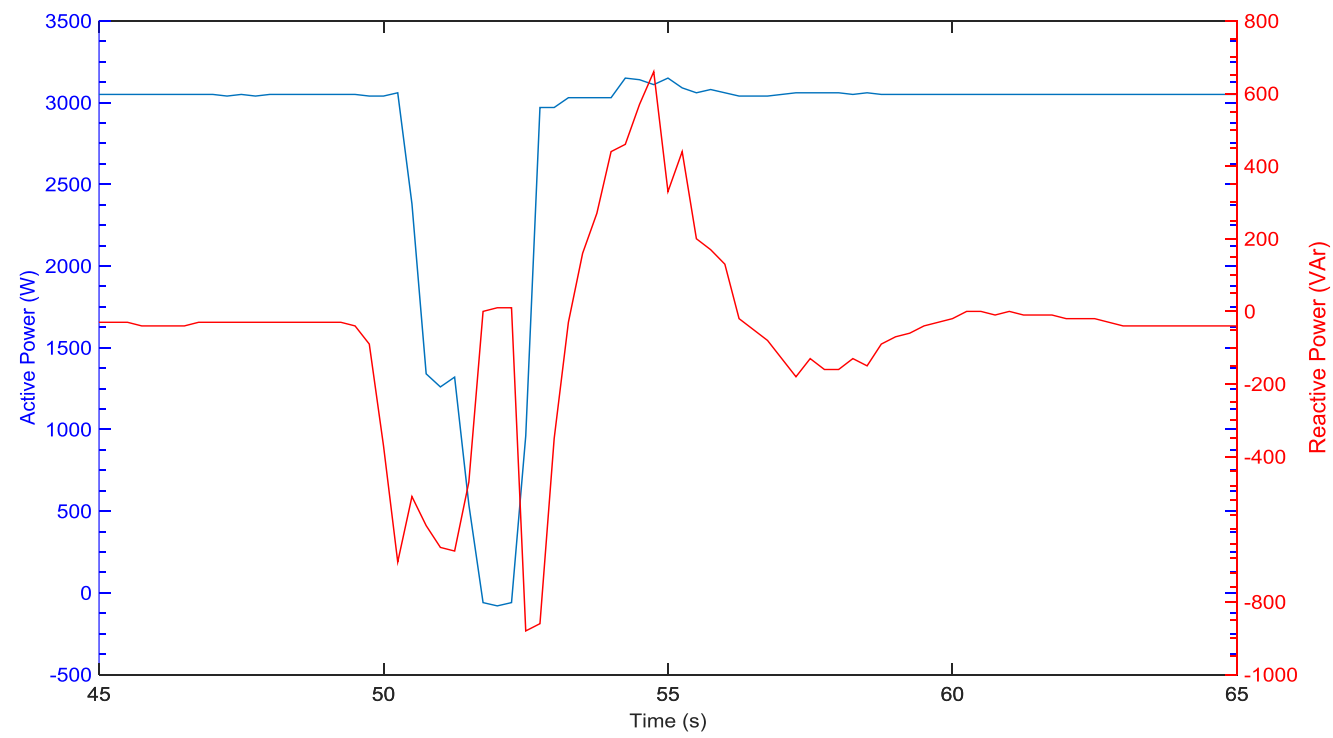


Figure 94 ABB inverter output active and reactive powers during +1Hz/s event

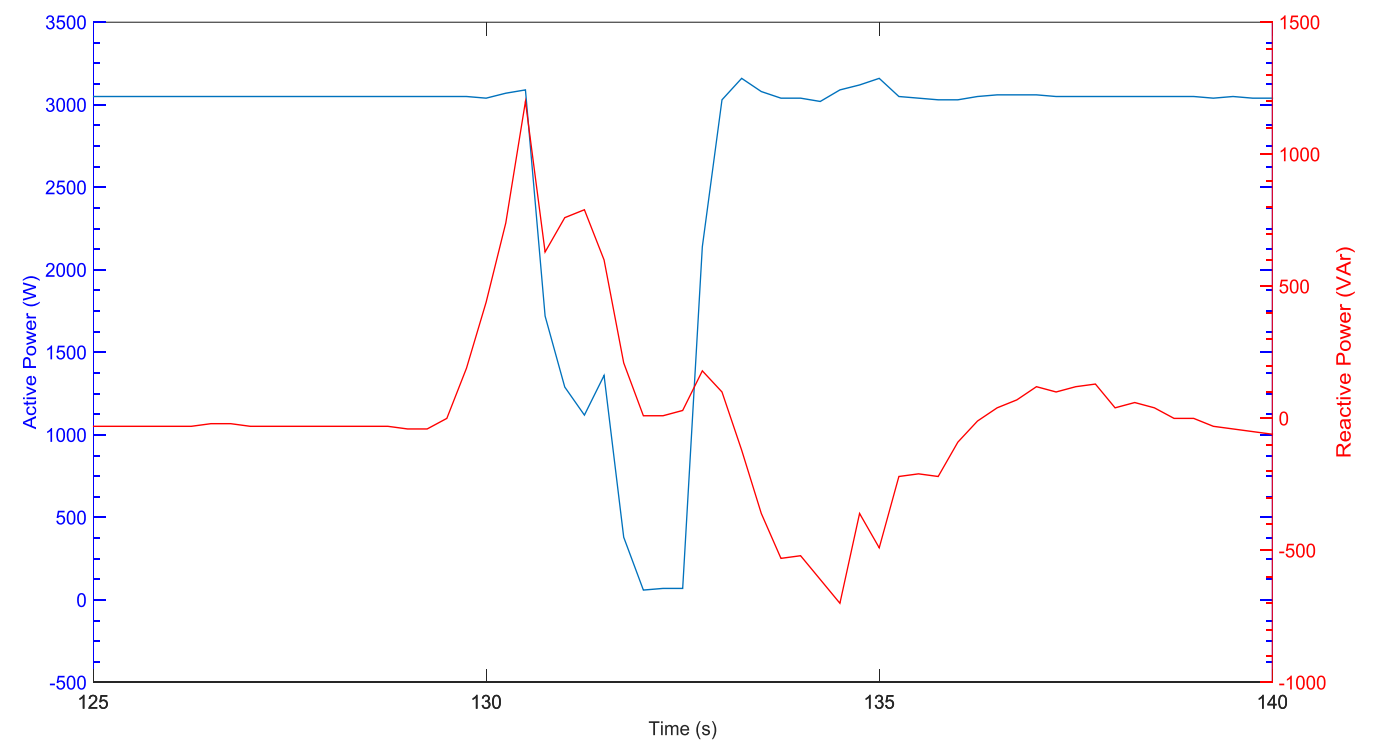


Figure 95 ABB inverter output active and reactive powers during -1Hz/s event

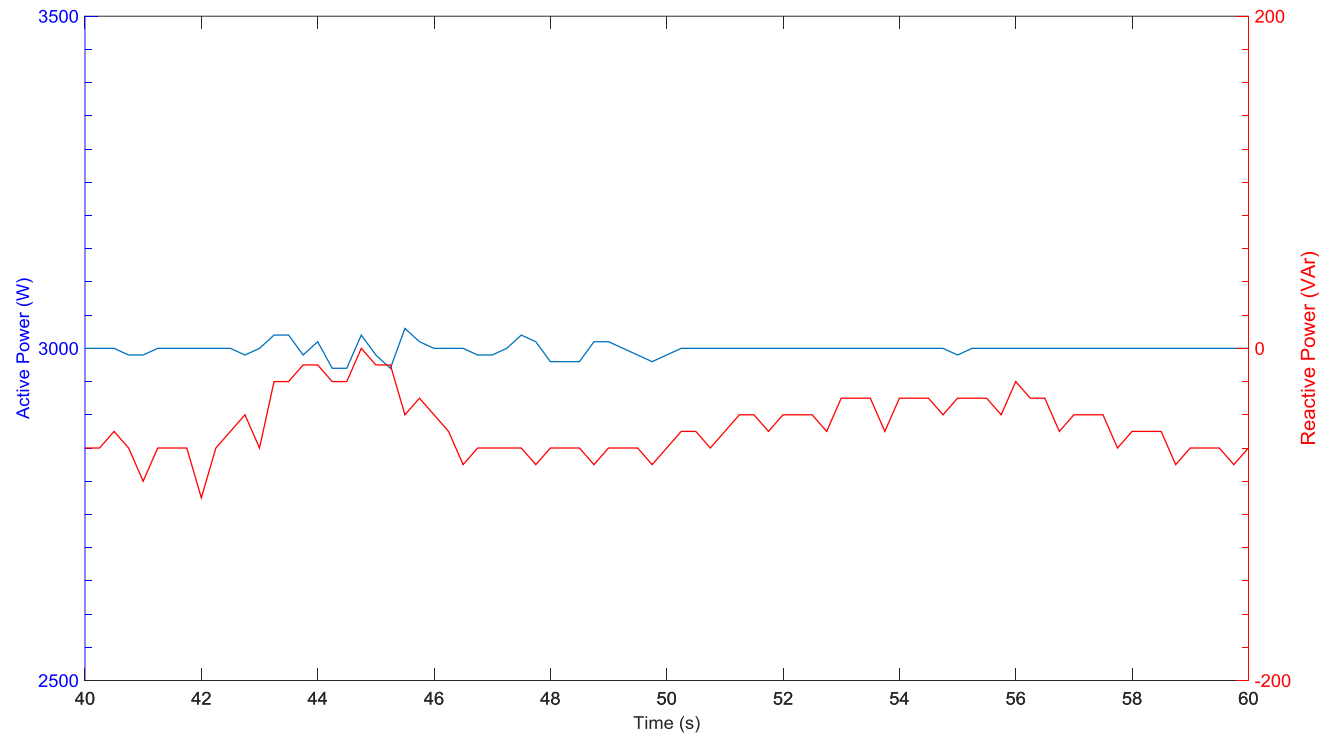


Figure 96 Kaco inverter output active and reactive powers during +1Hz/s event

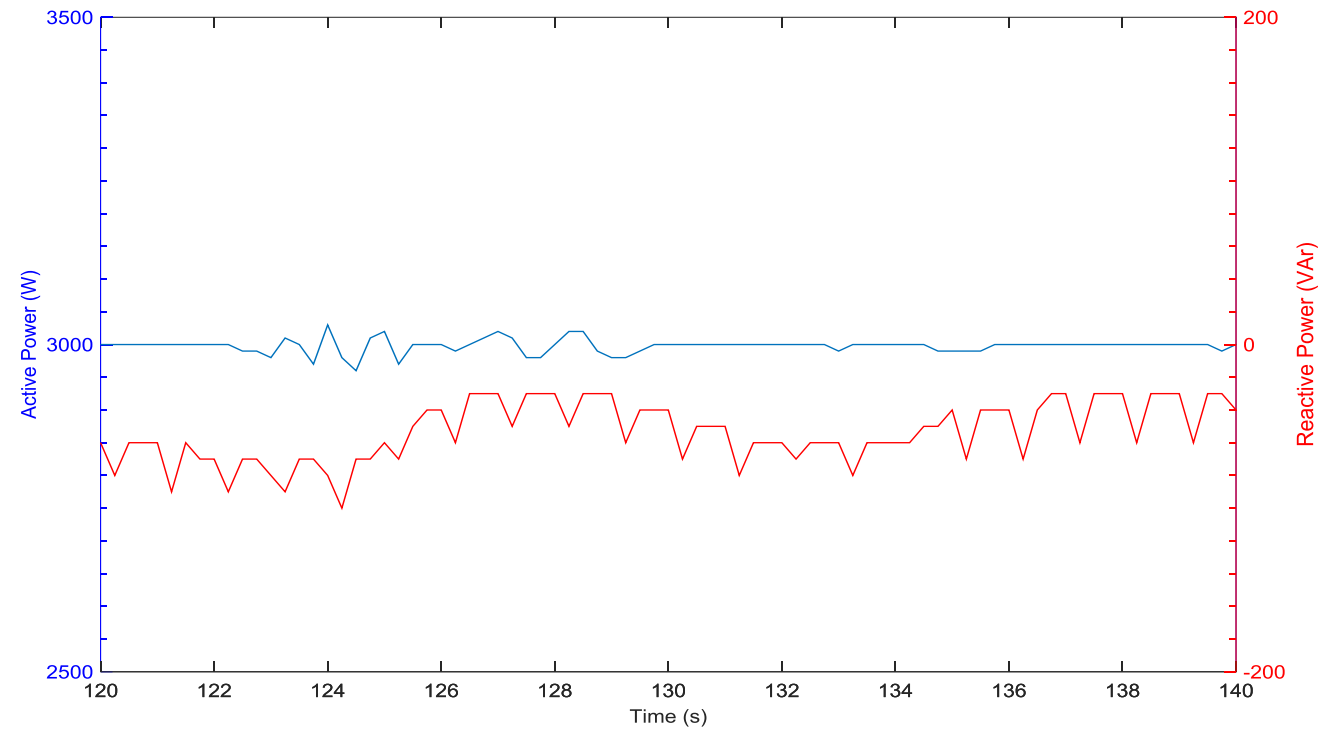


Figure 97 Kaco inverter output active and reactive powers during -1Hz/s event



Fronius and Kaco inverters connected simultaneously

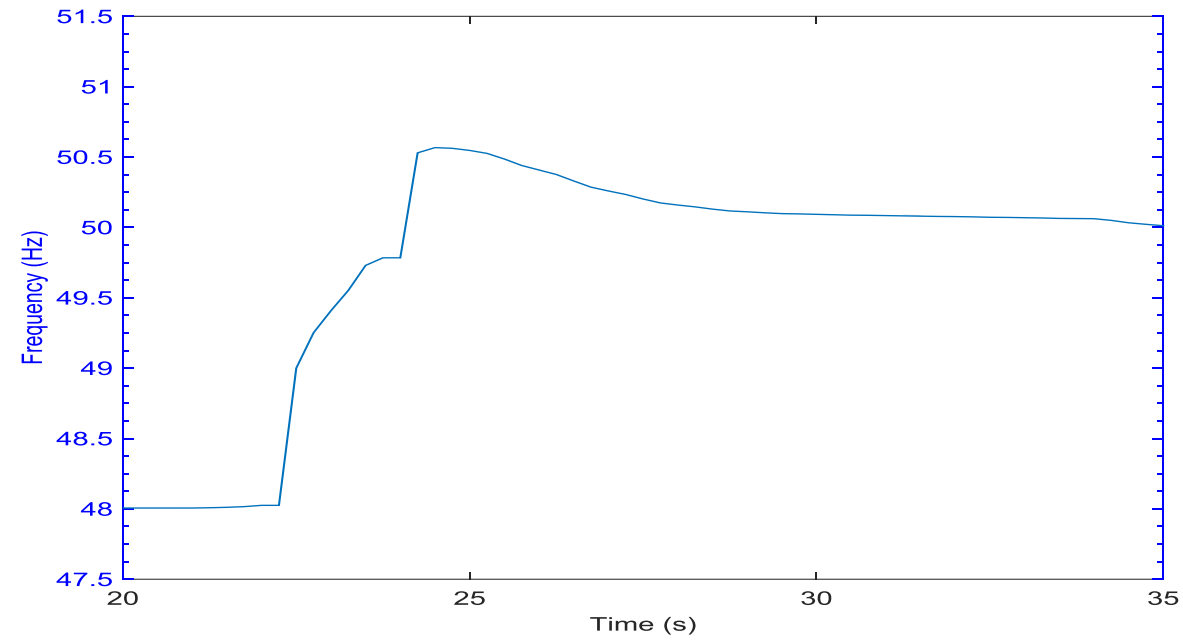


Figure 98 Average frequency during +1Hz/s event

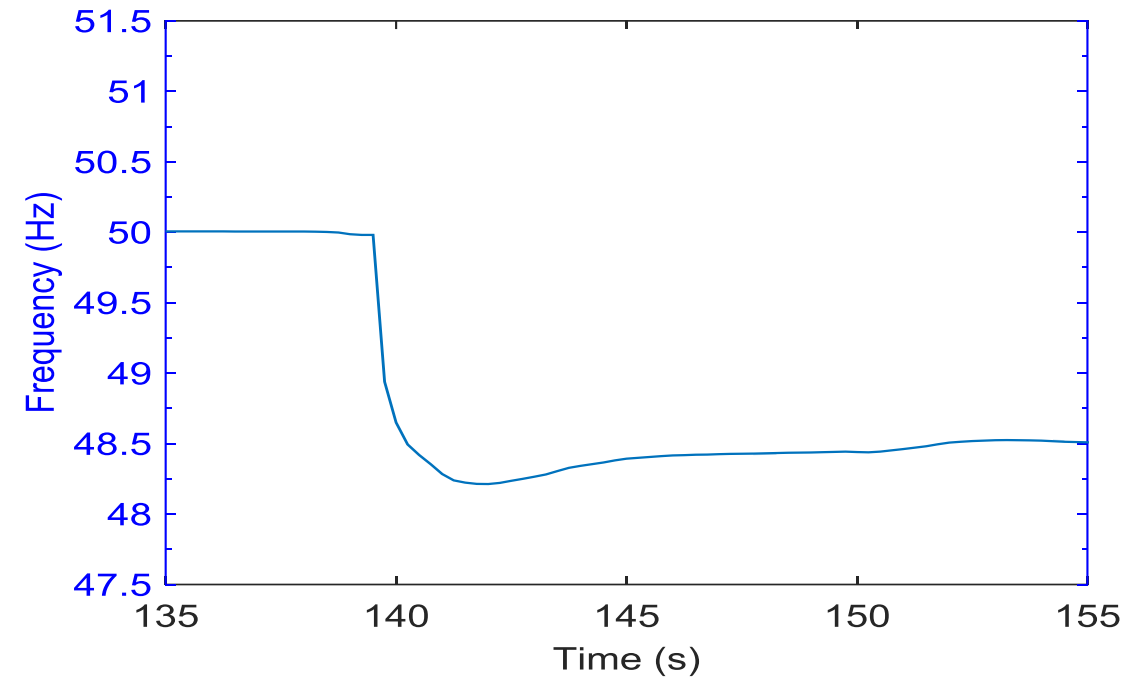


Figure 99 Average frequency during -1Hz/s event

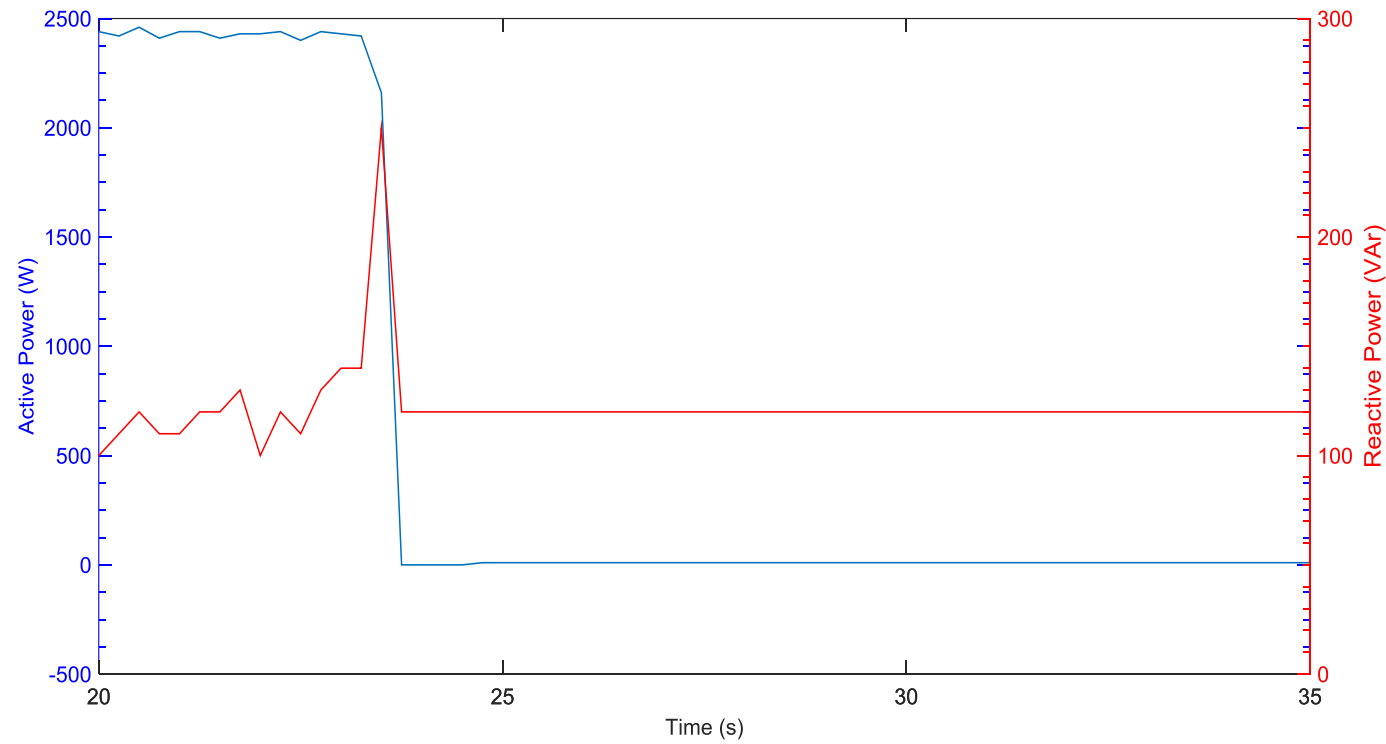


Figure 100 Fronius inverter output active and reactive powers during +1Hz/s event

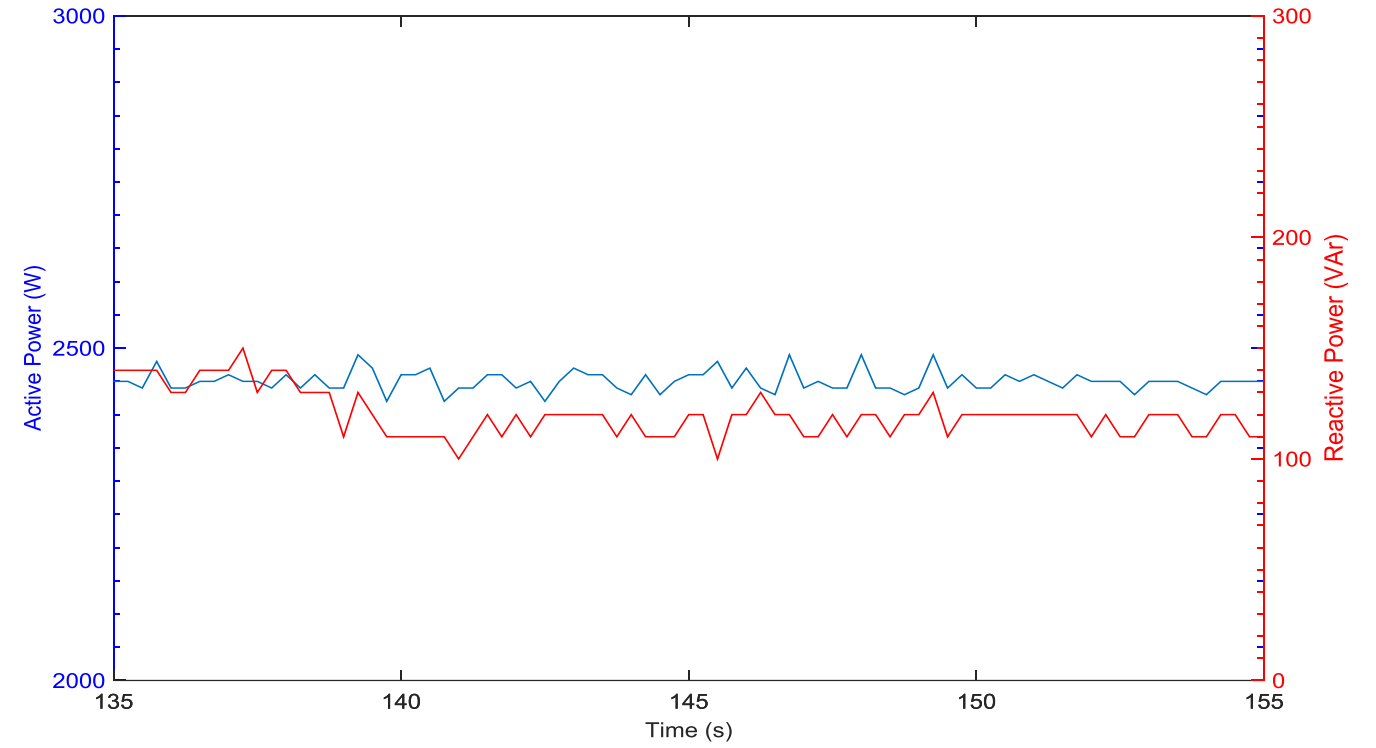


Figure 101 Fronius inverter output active and reactive powers during -1Hz/s event

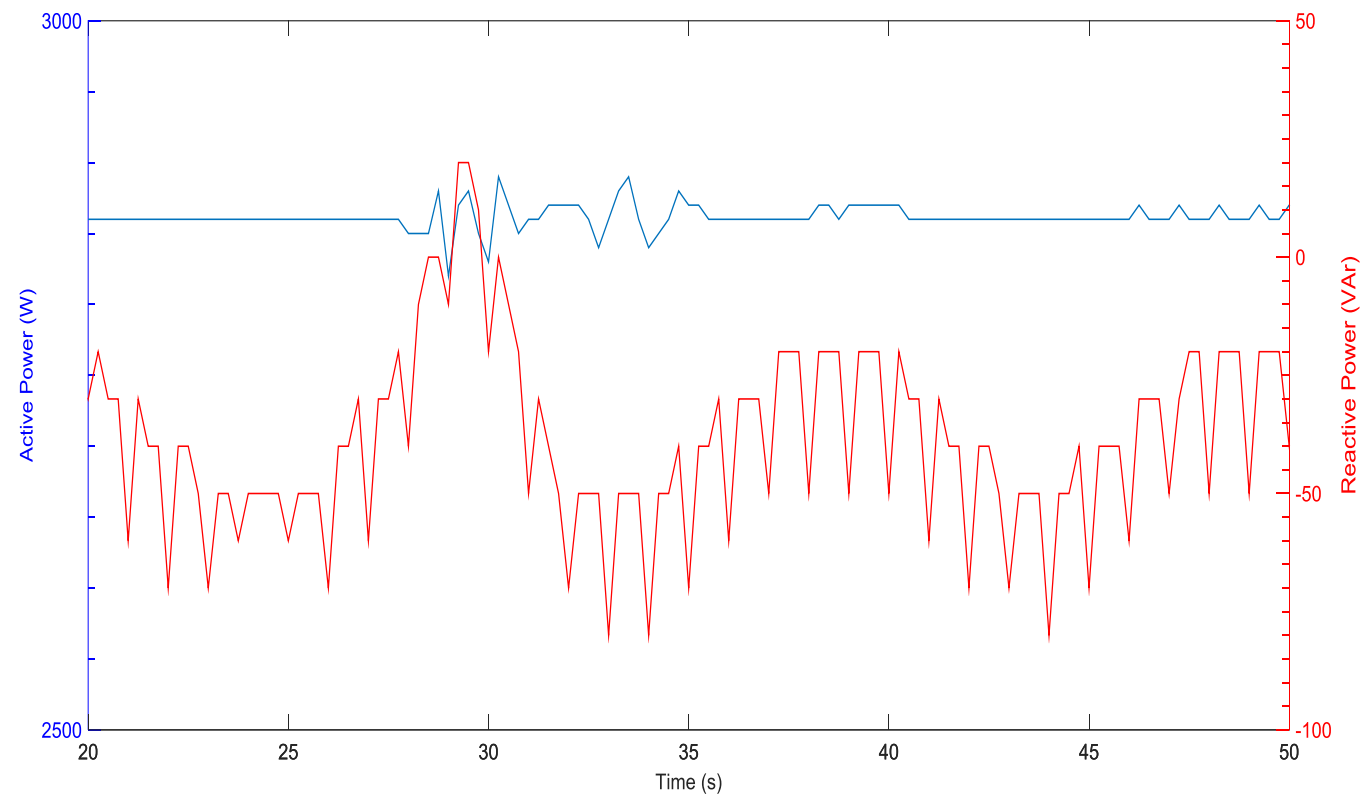


Figure 102 Kaco inverter output active and reactive powers during +1Hz/s event

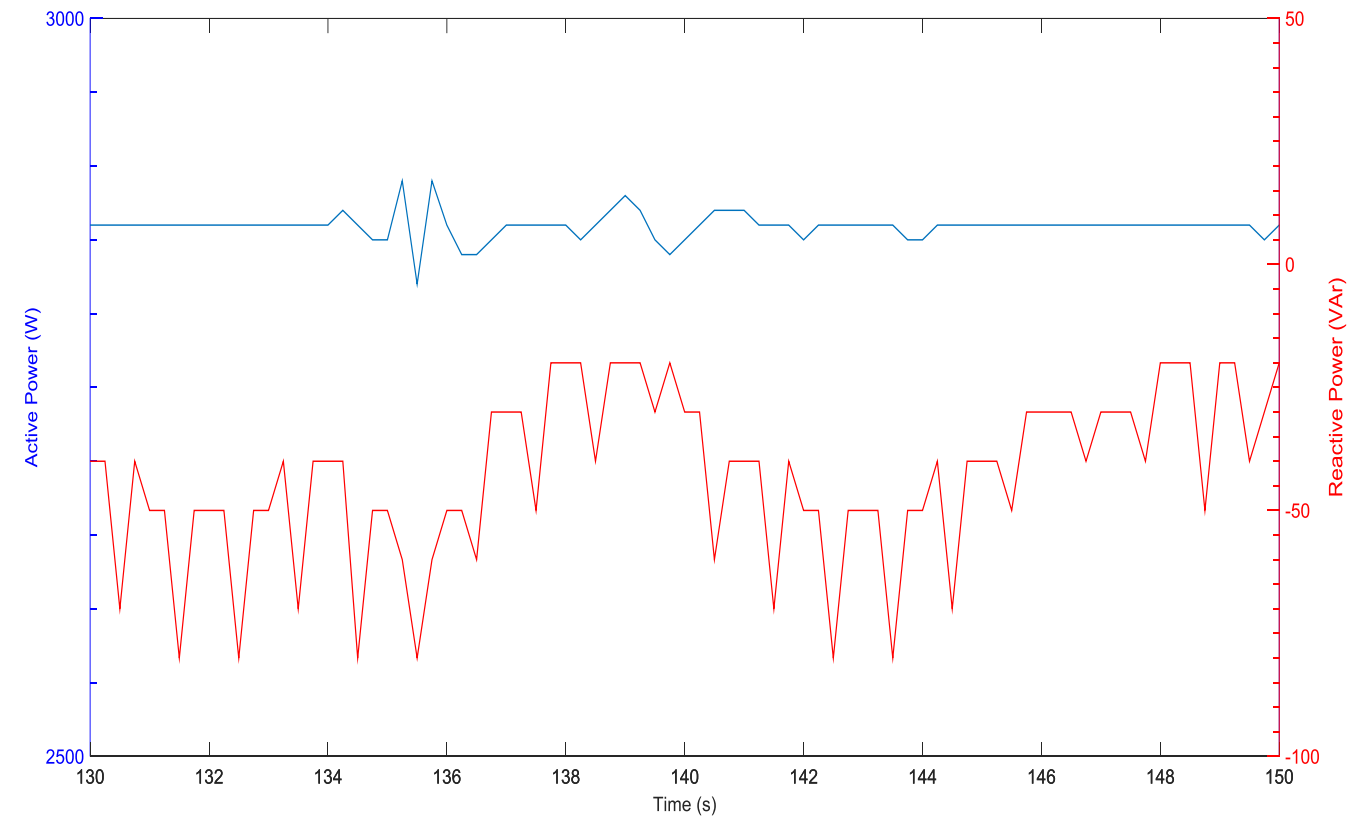
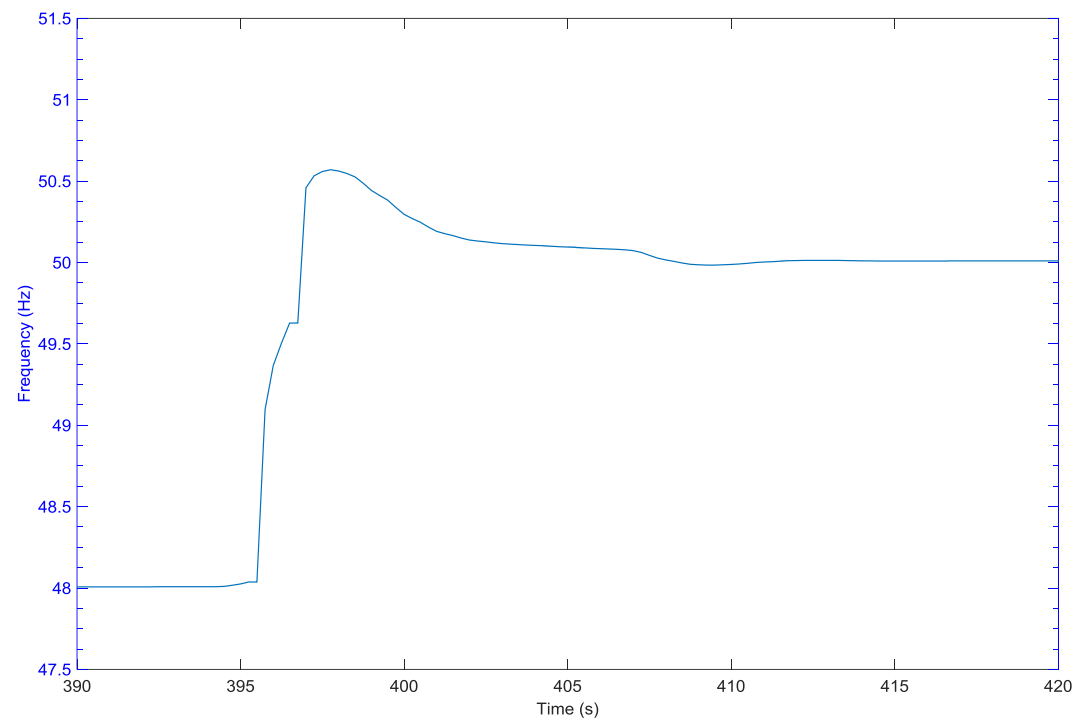
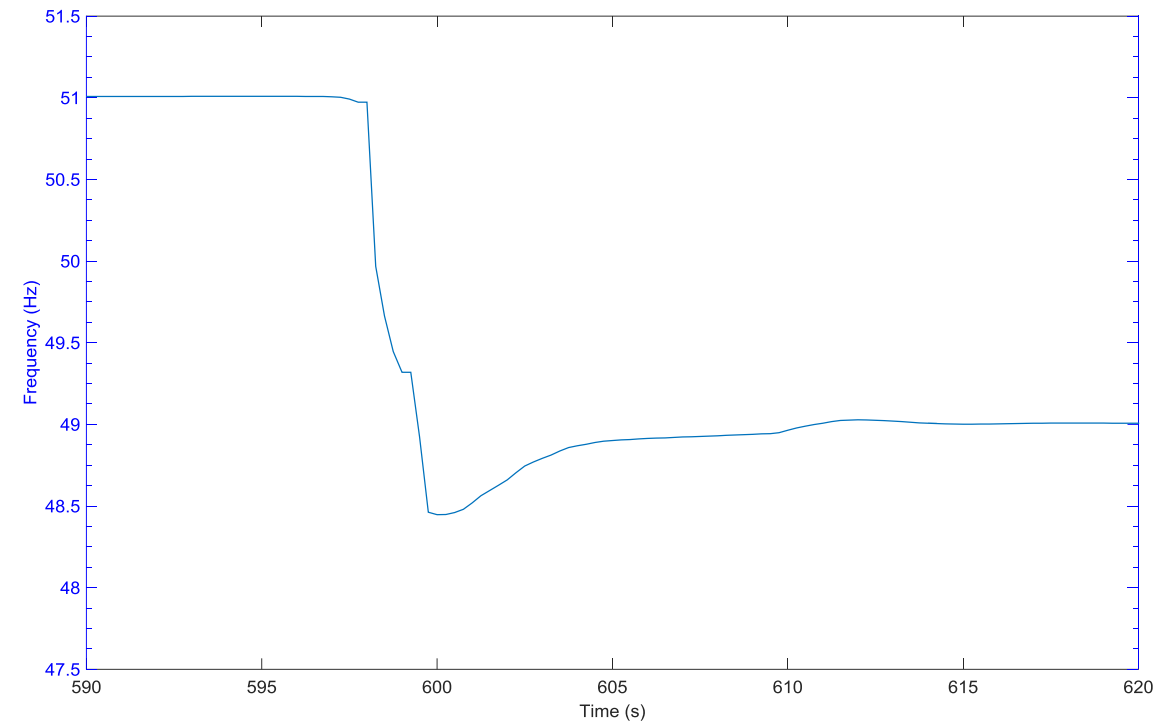


Figure 103 Kaco inverter output active and reactive powers during -1Hz/s event

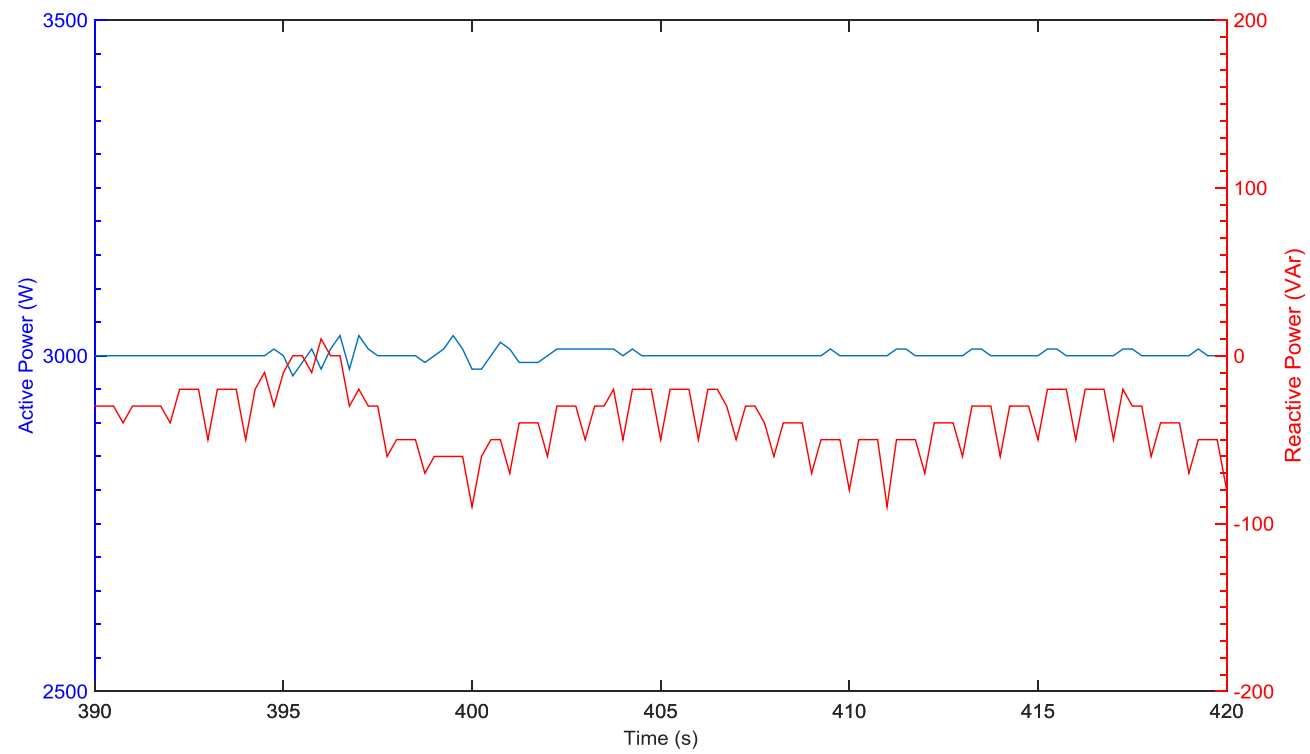
Kaco and SMA inverters connected simultaneously



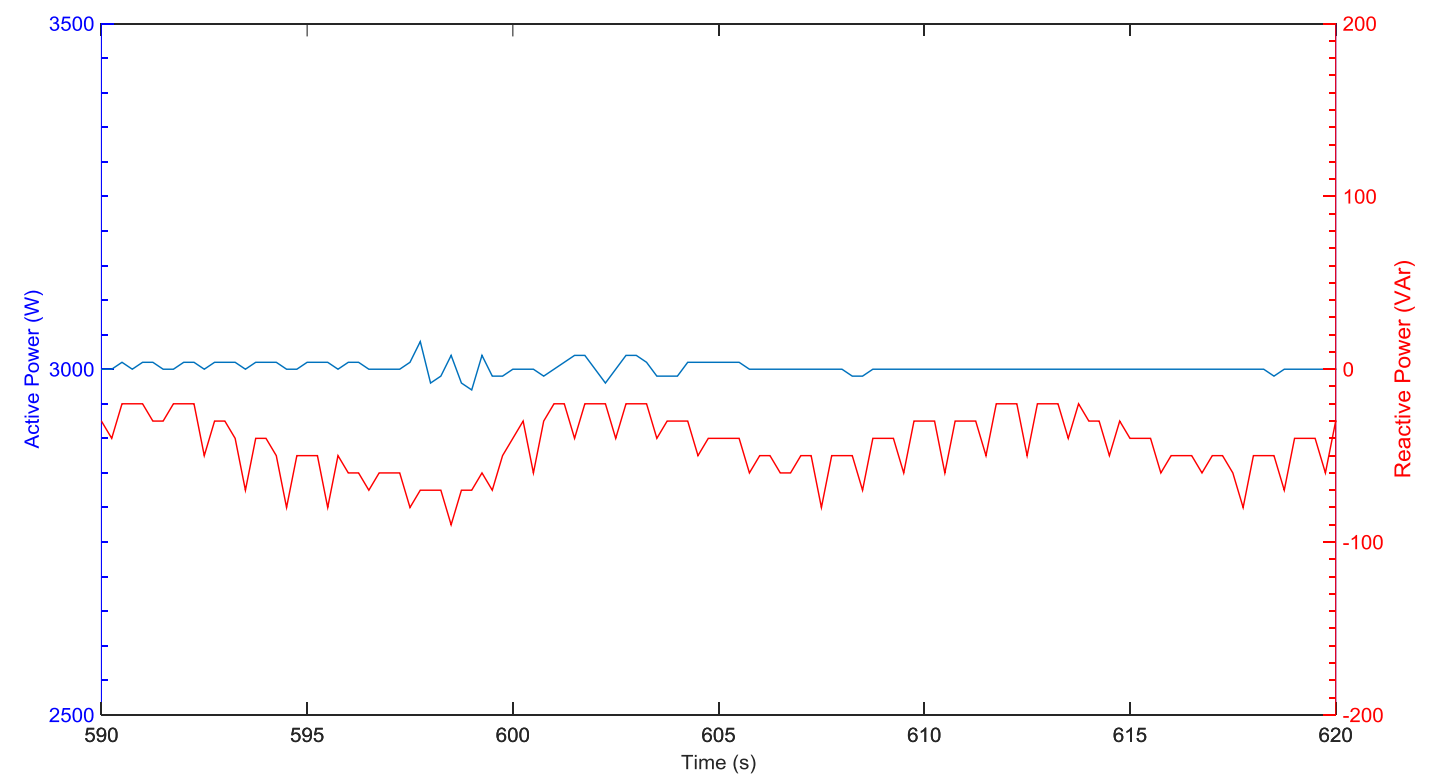
**Figure 104 Average frequency during +1Hz/s event**



**Figure 105 Average frequency during -1Hz/s event**



**Figure 106 Kaco inverter output active and reactive powers during +1Hz/s event**



**Figure 107 Kaco inverter output active and reactive powers during -1Hz/s event**

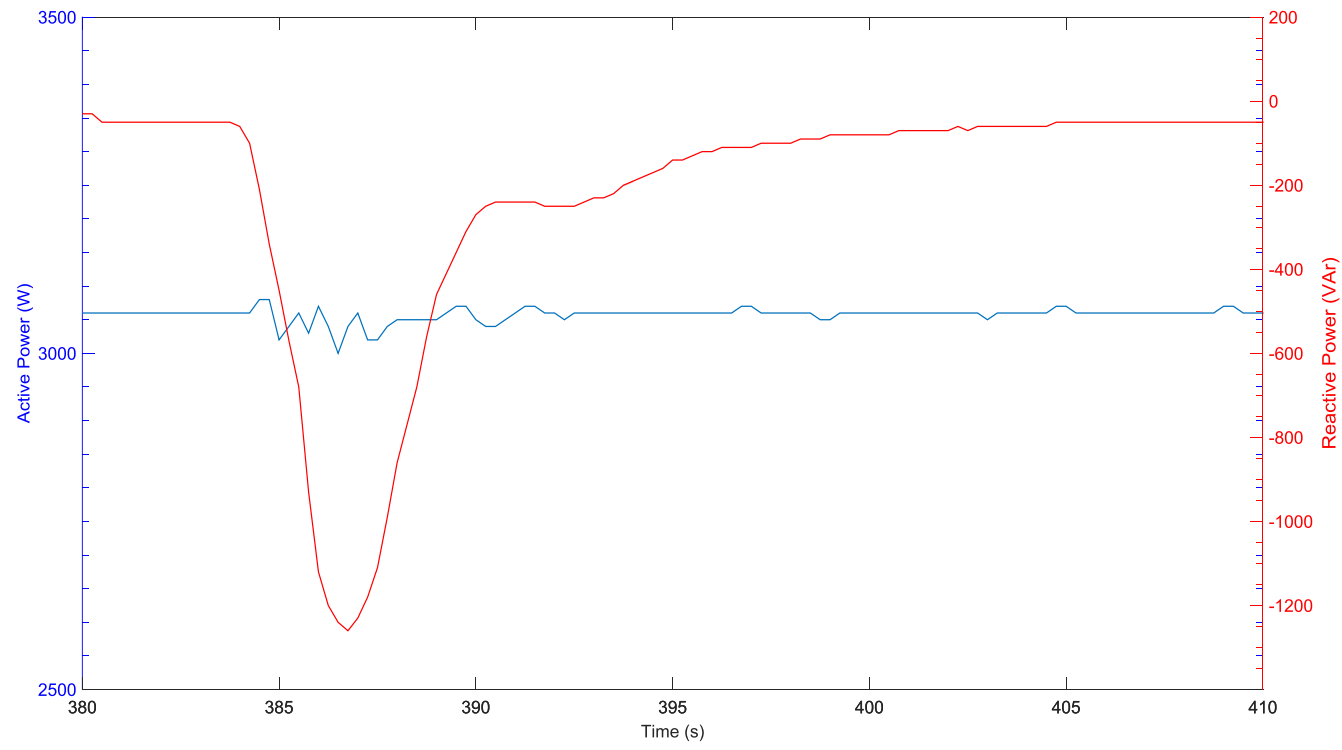


Figure 108 SMA inverter output active and reactive powers during +1Hz/s event

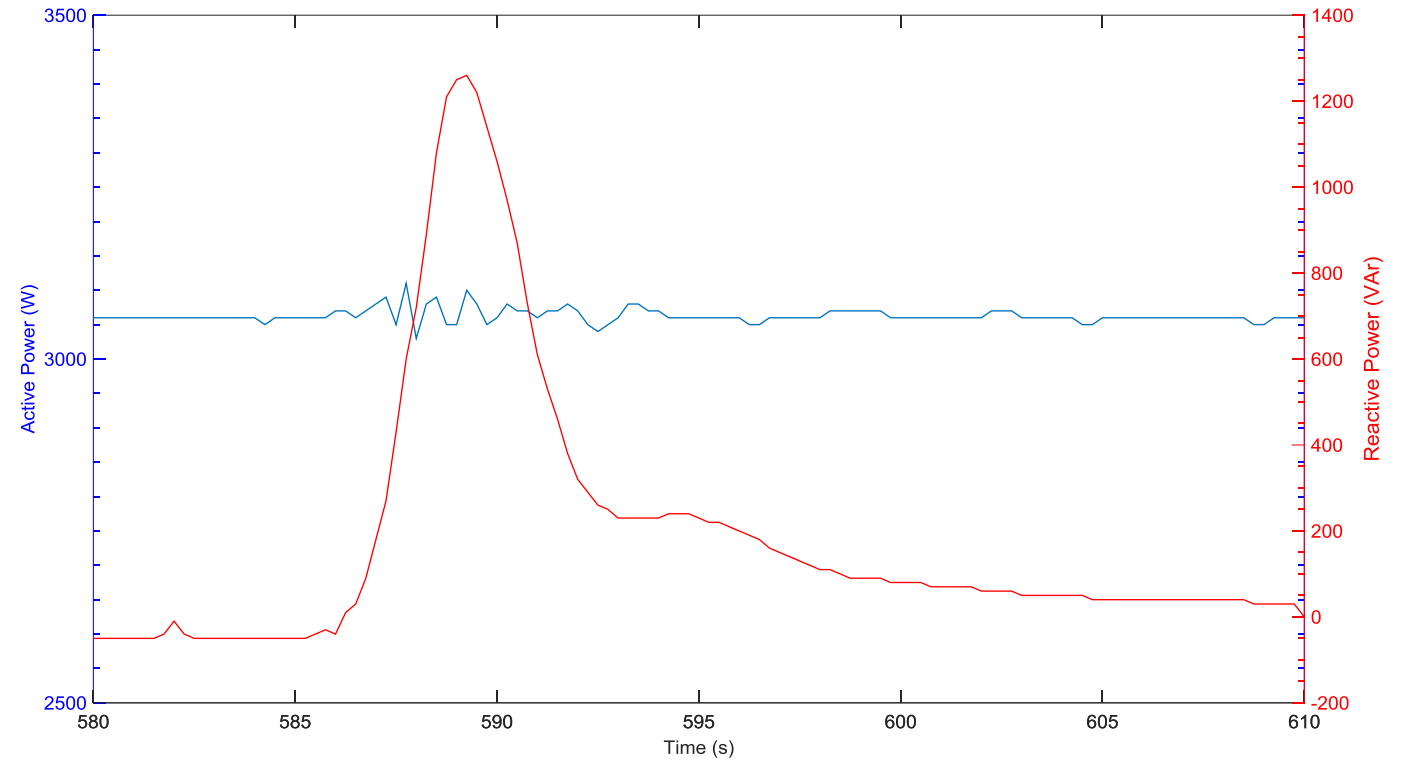


Figure 109 SMA inverter output active and reactive powers during -1Hz/s event

## Appendix C – Graphs of category 3 test measurements

ABB and Kaco inverters connected simultaneously

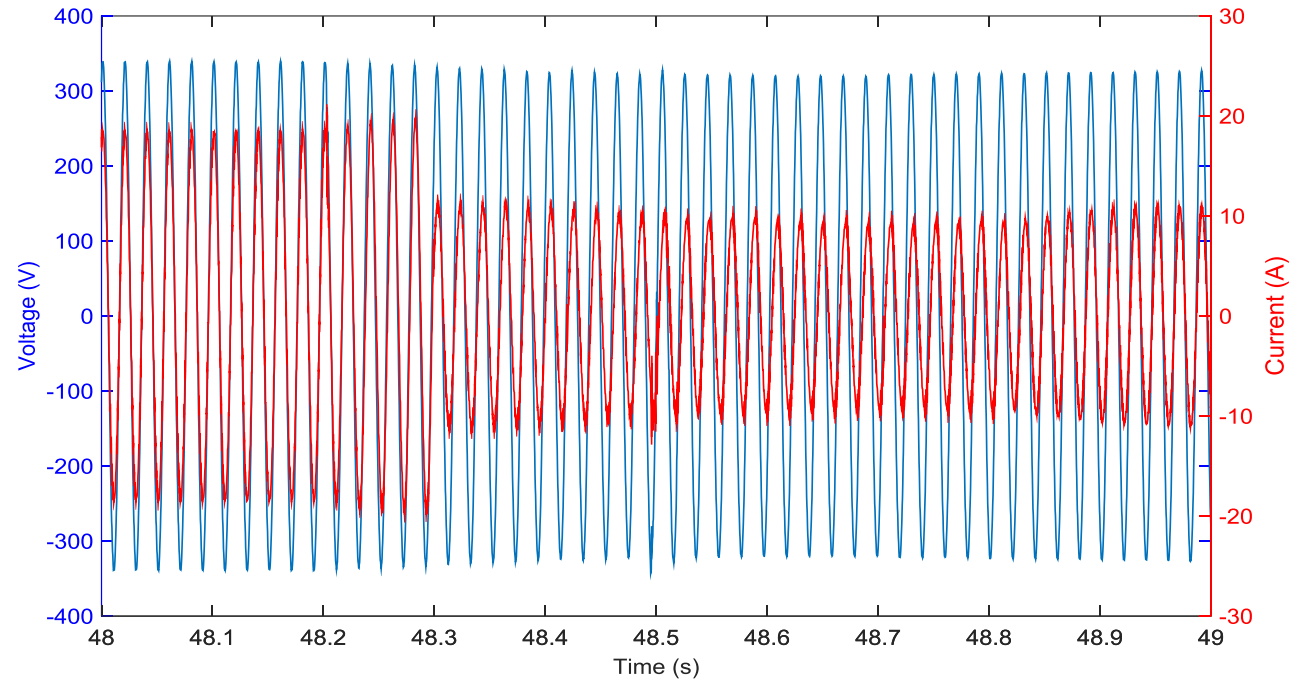


Figure 110 ABB inverter output during event

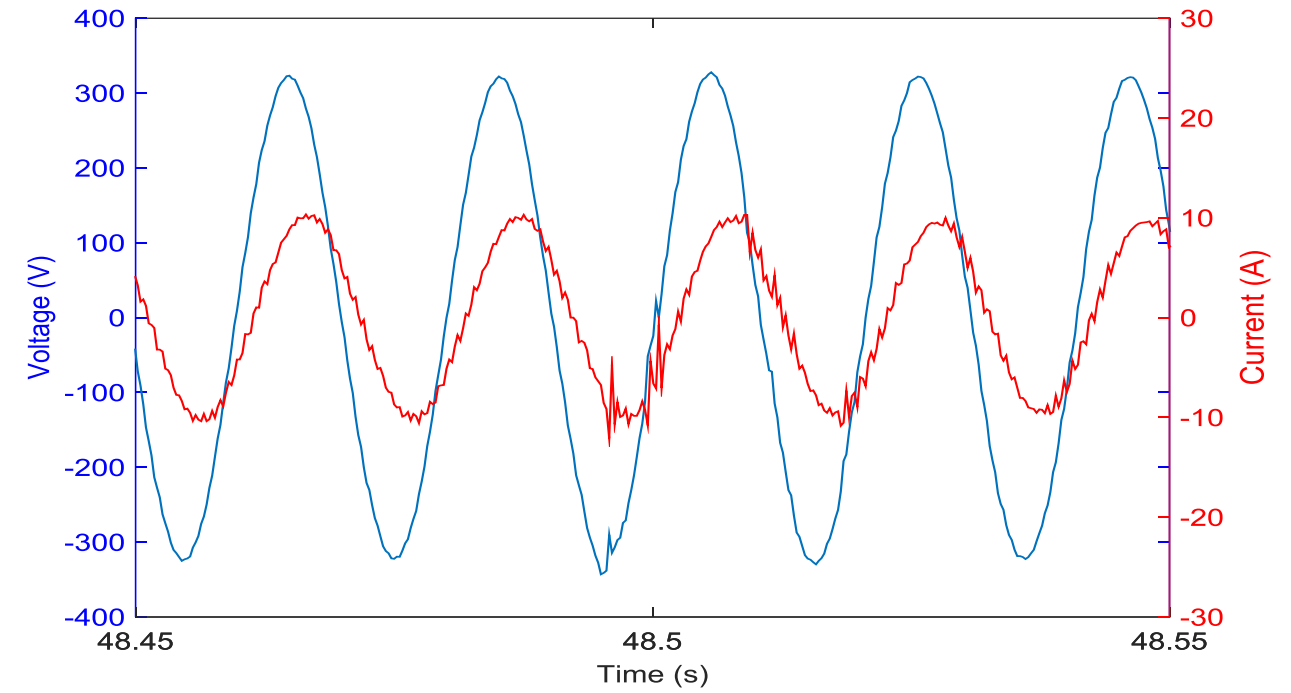


Figure 111 ABB inverter output close up of waveform showing voltage phase shift

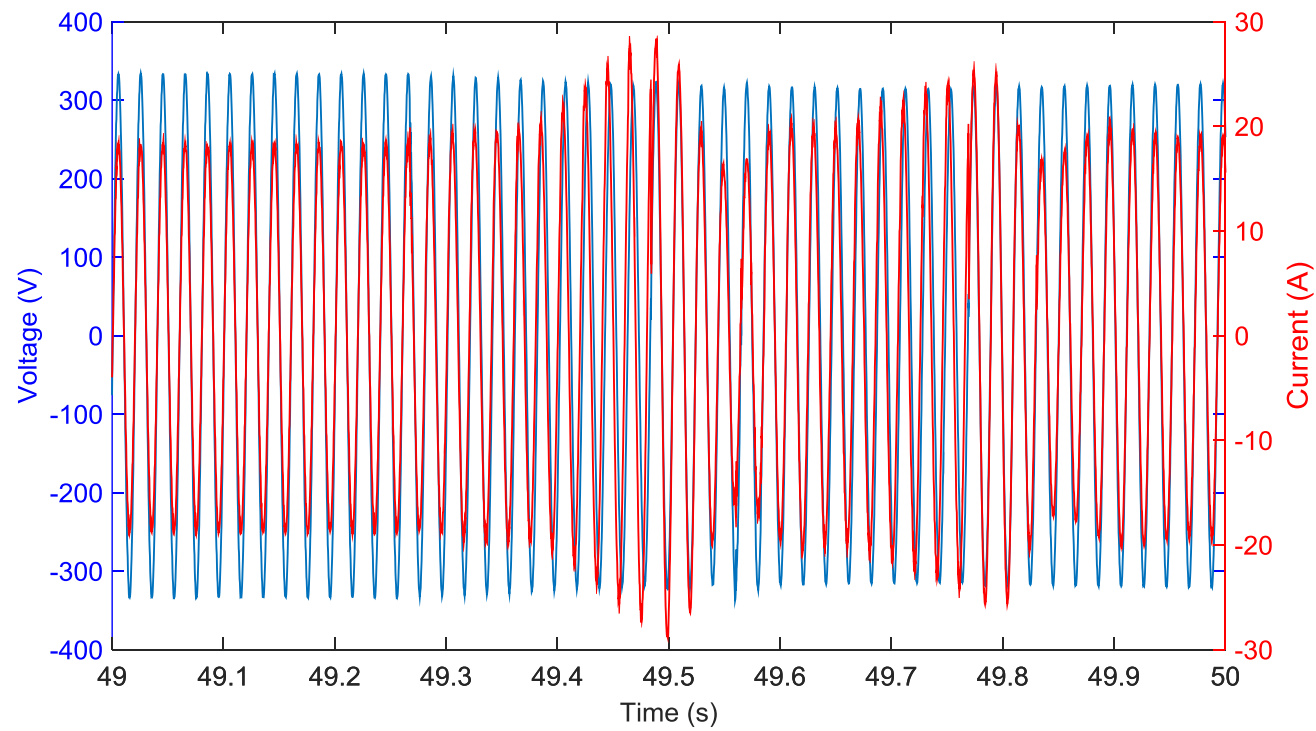


Figure 112 Kaco inverter output during event

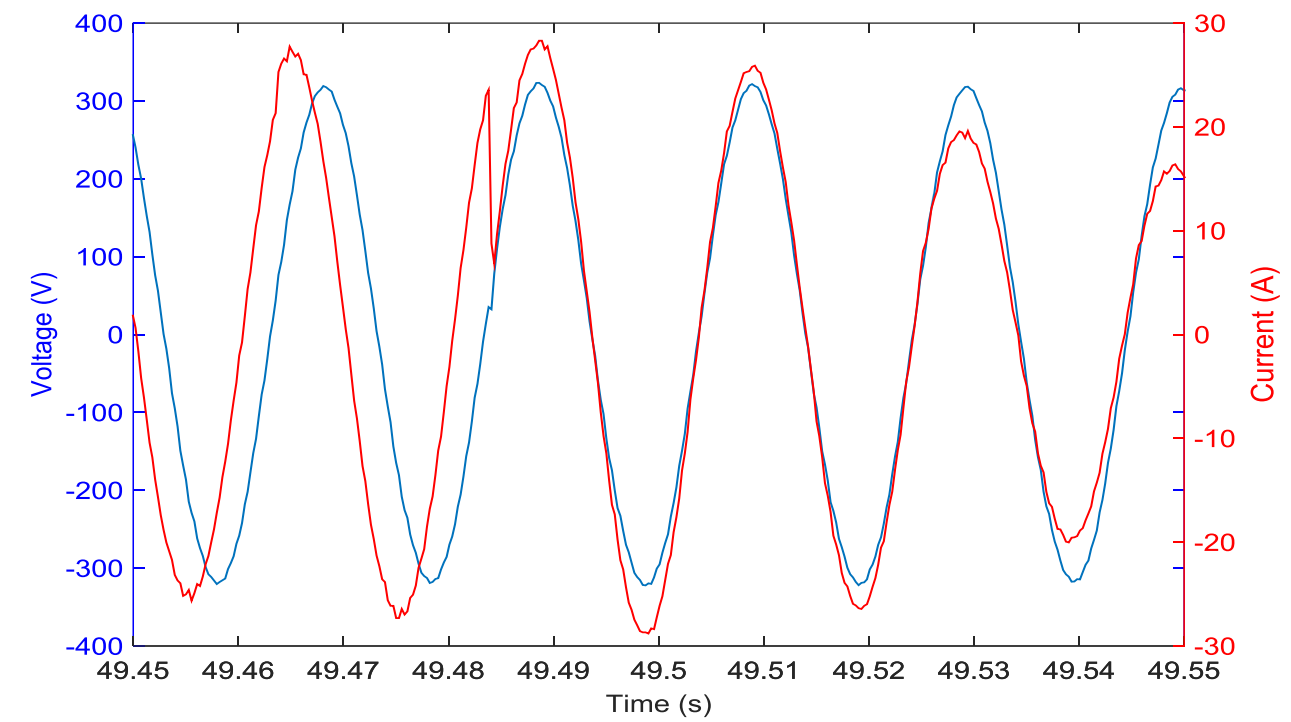


Figure 113 Kaco inverter output close up of waveform showing voltage phase shift

Fronius and SMA inverters connected simultaneously

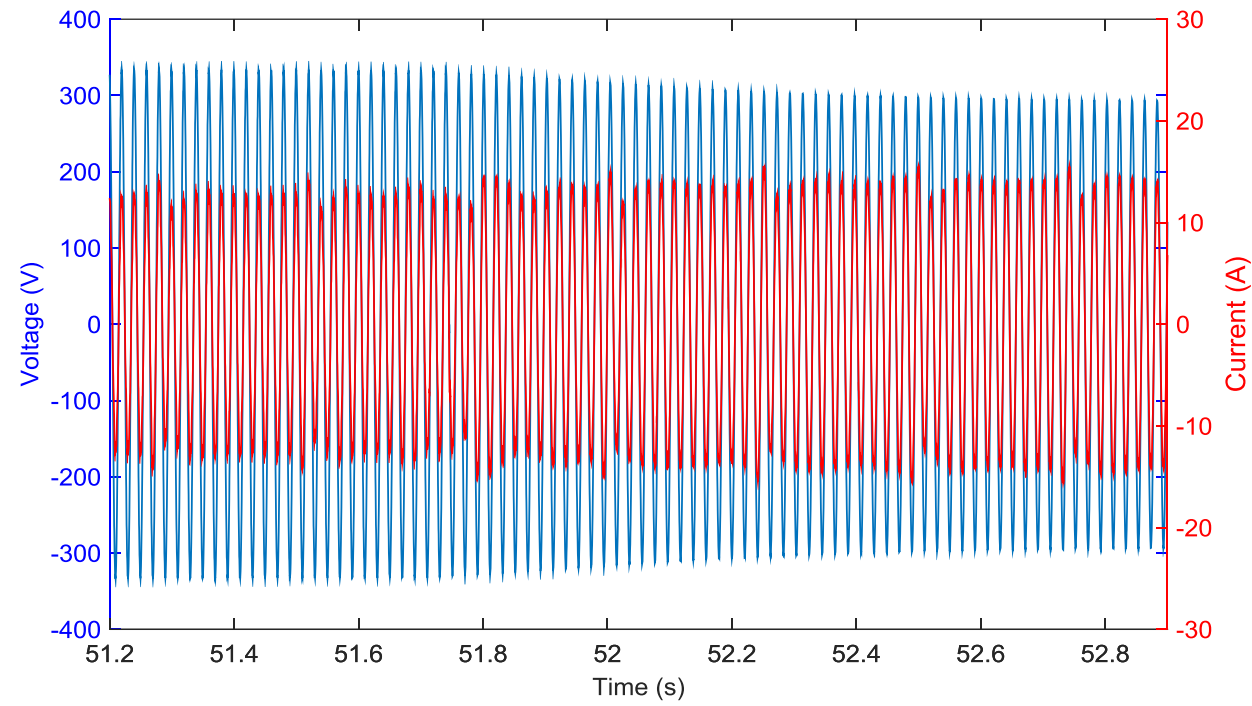


Figure 114 Fronius inverter output during event

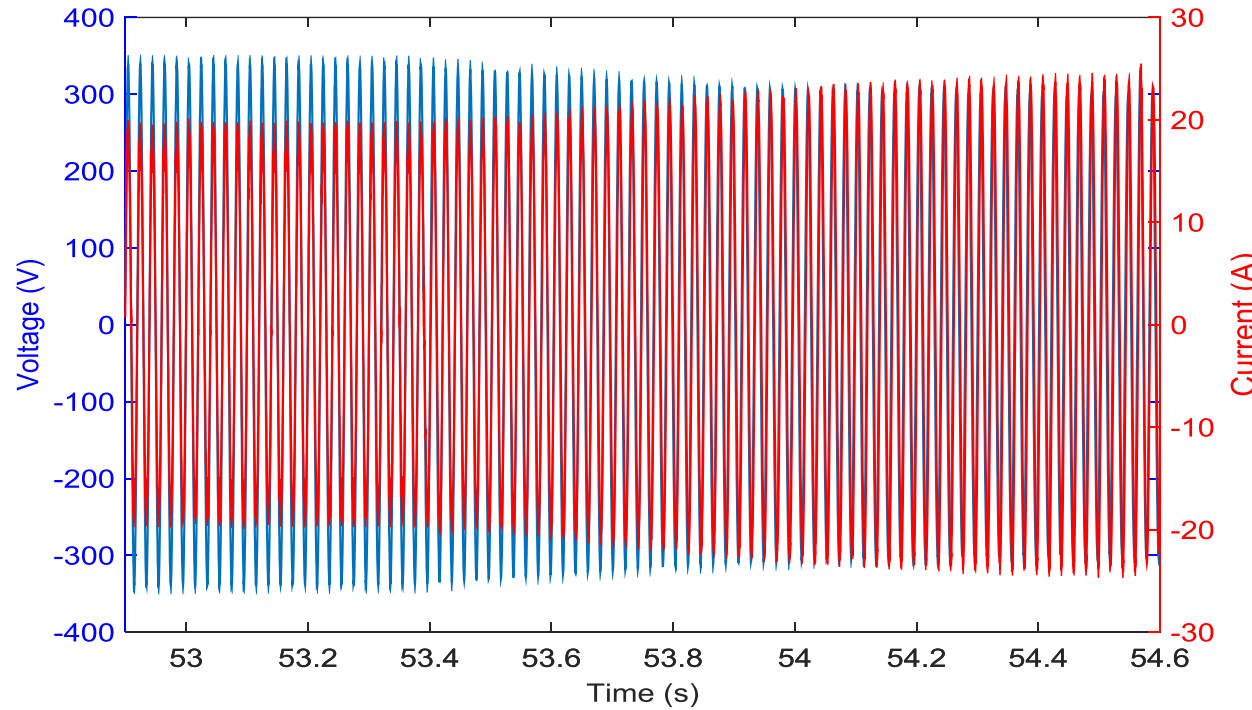


Figure 116 SMA inverter output during event

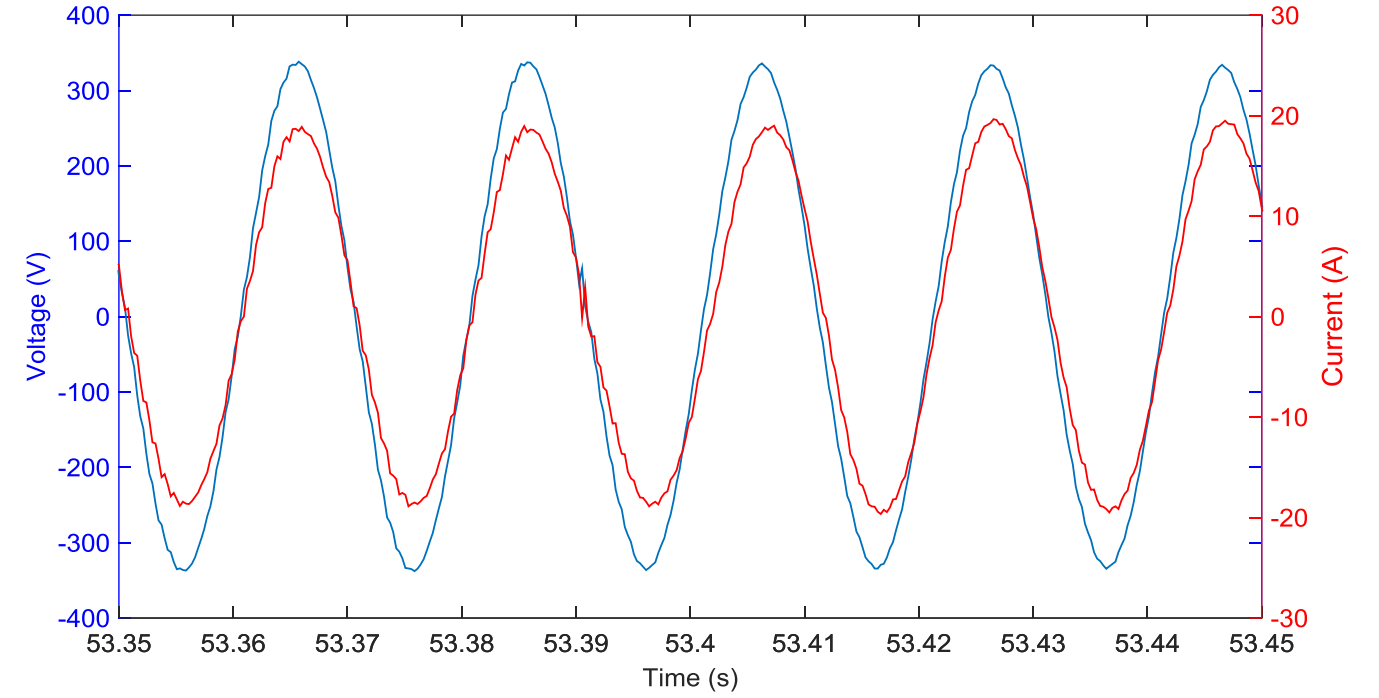


Figure 115 Fronius inverter output close up of waveform showing voltage phase shift

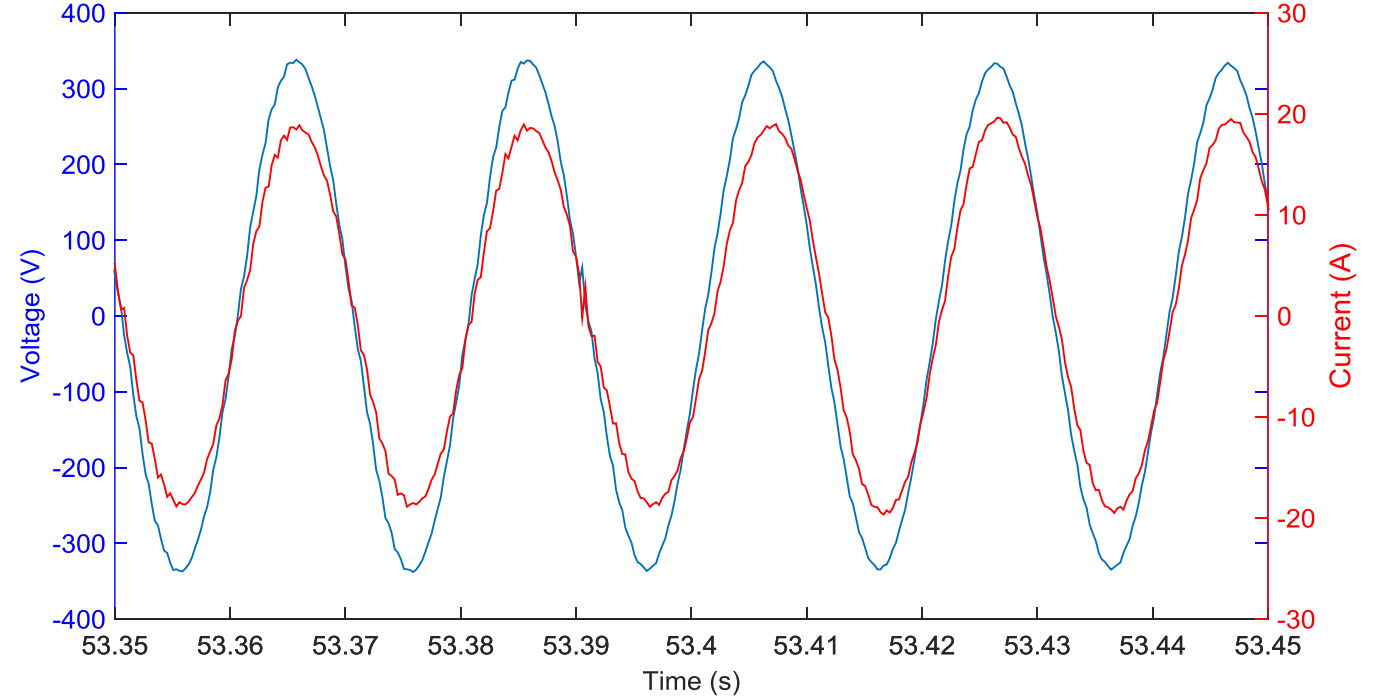
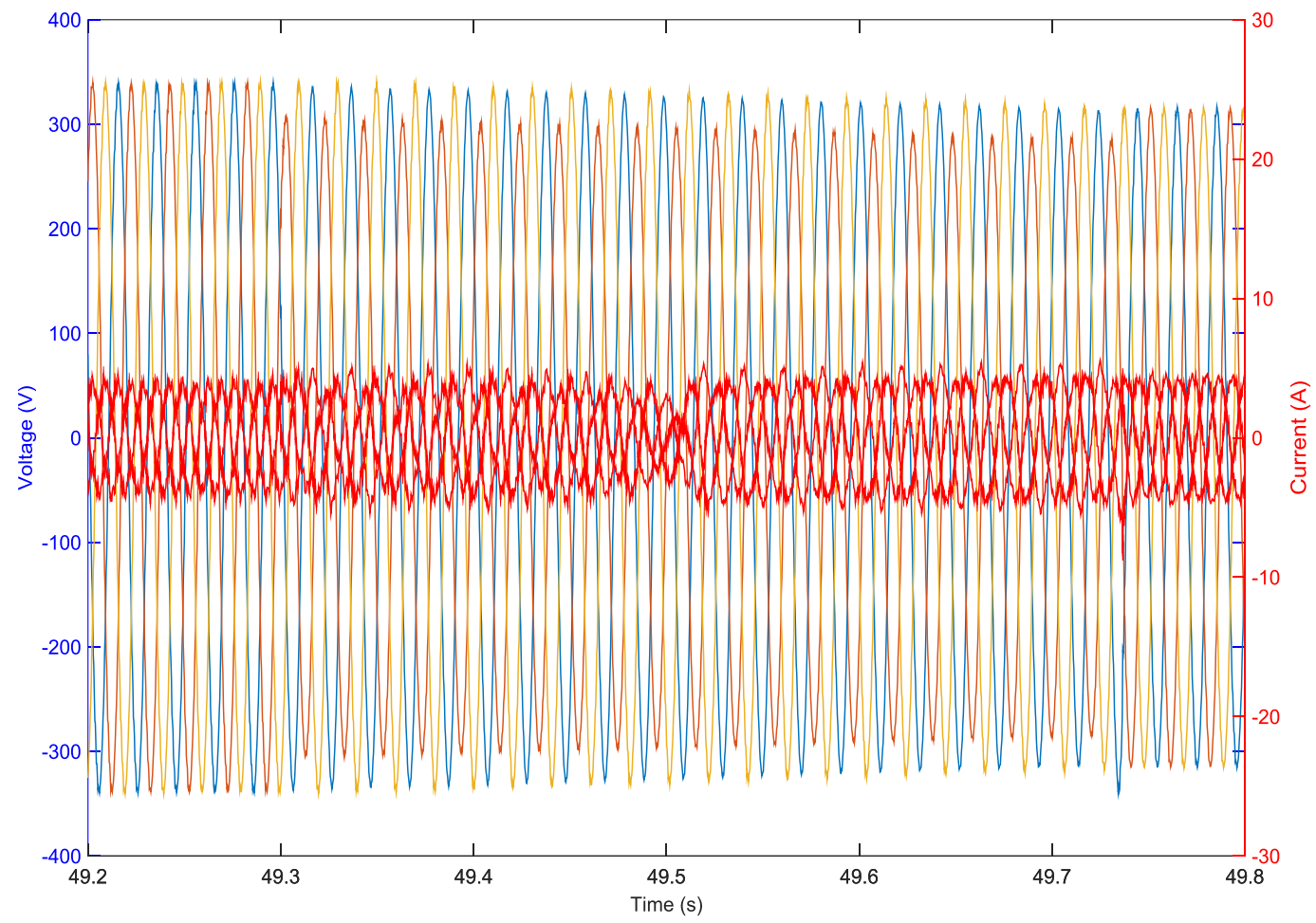
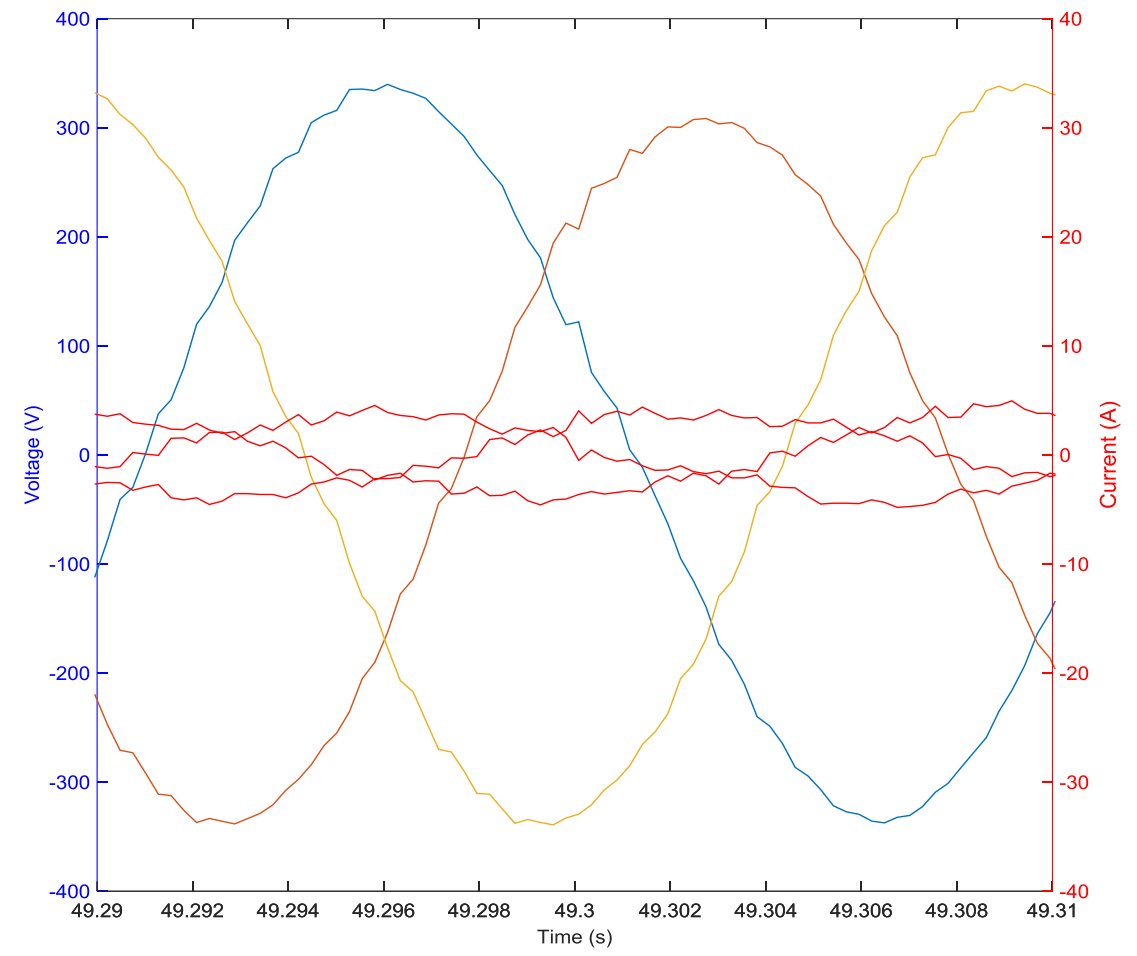


Figure 117 SMA inverter output close up of waveform showing voltage phase shift

SMA three phase inverter only connected



**Figure 118 SMA inverter output during event**



**Figure 119 SMA inverter output close up of waveform showing voltage phase shift**