

Assessment of Risks Resulting from the Adjustment of ROCOF Based Loss of Mains Protection Settings

Phase II

Authors

Dr Adam Dyśko
Dimitrios Tzelepis
Dr Campbell Booth

This work was commissioned by the Energy Networks Association and prepared for the workgroup “Frequency changes during large system disturbances” (GC0079)

October 2015

Institute for Energy and Environment
Department of Electronic and Electrical Engineering
University of Strathclyde
Glasgow

Table of Contents

Abbreviations and symbols	3
1 Executive Summary	4
2 Introduction	6
2.1 Methodology	6
3 WP2 – Simulation based assessment of NDZ	8
3.1 Network modelling	8
3.2 DG Models and Controls.....	8
3.2.1 Synchronous Generator	9
3.2.2 Photovoltaic Panels (PV).....	9
3.2.3 Doubly fed induction generator.....	10
3.3 NDZ Evaluation	11
3.3.1 Determining the NDZ.....	12
3.4 NDZ results	13
4 WP3 – Risk level calculation at varying NDZ.....	18
4.1 Risk Calculation Methodology	18
4.1.1 Expected number of LOM occurrences in a single islanding point	19
4.1.2 Load and generation profile analysis.....	19
4.1.3 Calculation of national LOM probability figures and individual risk	22
4.2 Initial assumptions and available data	24
4.2.1 Potential islanding scenarios and estimated frequency of occurrence	25
4.2.2 DG connection register analysis	26
4.2.3 Usage of ROCOF LOM protection	32
4.2.4 Load profile data.....	33
4.2.5 DG generation profiles.....	36
4.2.6 Generation load factor	38
4.3 Risk calculation results	39
4.3.1 Calculation of overall figures	39
5 Conclusions	41
6 References	44
Appendix A: Simulation model parameters	45
Appendix B: Detailed record of NDZ Assessment	47
B.1. Tabular Results.....	47
B.2. NDZ Graphs	51
Appendix C: Full record of risk assessment results	63
C.1. Summary Results.....	63
C.2. Detailed results for different generation mixes and load profiles.....	65
C.3. Result figures.....	75
Appendix D: Terms of Reference.....	80

Abbreviations and symbols

NDZ	- Non-Detection Zone
LOM	- Loss-Of-Mains
P_L, Q_L	- active and reactive power of the load
P_{DGG}, Q_{DGG}	- active and reactive power supplied by the group of distributed generators
NDZ_{PE}, NDZ_{QE}	- exporting NDZ (generator output is higher than the local load during LOM)
NDZ_{PI}, NDZ_{QI}	- importing NDZ (generator output is lower than the local load during LOM)
T_{NDZmax}	- maximum permissible duration of undetected islanding operation
n_{NDZ}	- number of detected NDZ periods
T_{load_record}	- total length of recorded load profile
$T_{NDZ(k)}$	- length of k -th NDZ period.
P_2	- probability of non-detection zone for generator group P_{DGG}, Q_{DGG}
P_3	- probability of non-detection zone duration being longer than T_{NDZmax}
$N_{LOG,IP}$	- expected number of incidents of losing supply to a single islanding point in 1 year
n_{LOG}	- number of Loss-Of-Grid incidents experienced during the period of T_{LOG} in a population of n_{IP} islanding points
$N_{LOM,1DGG}$	- expected annual number of undetected islanding operations longer than the assumed maximum period T_{NDZmax} for a single DG
T_{NDZavr}	- overall average duration of the NDZ
T_{LOMavr}	- overall average duration of the undetected islanded condition
T_{ARmax}	- expected maximum time of auto-reclose scheme operation
$n_{DGG(m)}$	- number of all connected distributed generator groups in a given generation mix m
$p_{ROCOF(m)}$	- proportion of generators with ROCOF protection in a given generation mix m
$LF_{(m)}$	- load factor for a given generation mix m
$N_{LOM(m)}$	- expected number of undetected islanding incidents in 1 year (in generation mix m)
$T_{LOM(m)}$	- total aggregated time of undetected islanding conditions in 1 year (in generation mix m)
$P_{LOM(m)}$	- probability of the occurrence of an undetected island within a period of 1 year (in generation mix m)
N_{LOM}	- expected national number of undetected islanding incidents in 1 year
T_{LOM}	- total aggregated time of undetected islanding conditions in 1 year
P_{LOM}	- overall probability of the occurrence of an undetected island within a period of 1 year
$P_{PER,E}$	- probability of a person in close proximity to an undetected energised islanded part of the system being killed
$P_{PER,G}$	- probability of a person in close proximity of the generator while in operation
IR	- annual probability related to individual risk
IR_E	- annual probability related to individual risk (injury or death of a person) from the energised parts of an undetected islanded network
P_{AR}	- probability of out-of-phase auto-reclosing action following the disconnection of a circuit supplying a primary substation
N_{OA}	- annual rate of occurrence of any generator being subjected to out-of-phase auto-reclosure during the islanding condition not detected by LOM protection
IR_{AR}	- annual probability related to individual risk from the generator destruction following an out-of-phase auto-reclosure.
WPD	- Western Power Distribution
ENW	- Electricity North West
UKPN	- UK Power Networks
SPD	- ScottishPower Distribution
NPG	- Northern Powergrid
SSE	- Scottish and Southern Energy

1 Executive Summary

This document contains a report on Phase II of the work undertaken by the University of Strathclyde and commissioned by the Energy Network Association on behalf of the workgroup “Frequency changes during large system disturbances” (GC0079). The workgroup is a joint activity of the UK Grid Code Review Panel (GCRP) and Distribution Code Review Panel (DCRP) which addresses the issue of system integrity under anticipated future low inertia conditions. The original terms of reference for this work issued by ENA in April 2014 are included in Appendix D of this report.

The aim of the work described in this report is to assess and quantify the risks associated with proposed changes to ROCOF protection settings from the point of view of undetected islands and the consequent risks to individuals’ safety, as well as the risk of potential equipment damage through unintentional out-of-phase auto-reclosing.

The report builds upon previous document [1] (prepared in Phase I) and ascertains whether the risk of non-detection, under the proposed setting changes, is acceptable in light of the Health and Safety at Work Act 1974 [2] and other related utility policies and guidelines. The current Phase II includes all distributed generator (DG) capacities below 5 MW, and covers the predominant existing generating technologies, namely synchronous, inverter and DFIG-based generation. To achieve the objectives of quantifying and assessing risk, detailed dynamic simulation work has been carried out to determine the potential islanding non-detection zone (NDZ) associated with different ROCOF settings (four setting options were stipulated by the workgroup members), and under a number of different islanding generation arrangements, including islanding of multiple generators.

The NDZ has been quantified in terms of the surplus/deficit power supplied by the DG prior to islanding and is expressed as a ratio of this power to the rating of the islanded DG (or the combined rating of multiple units when more than one generator is islanded). The dynamic simulation work uses a transient model of the utility network including generation, and a numerical model of a DG interface relay commonly used in the UK. Thus established NDZ levels have been subsequently utilised by the developed risk assessment methodology to determine the probability of islanding non-detection and to quantify the consequential associated risks. In addition to the NDZ data, the methodology makes use of recorded load profiles, and historical statistics relating to customer interruptions and network incidents.

During the NDZ assessment the operation of both ROCOF and G59 protection (Overvoltage - OV, Undervoltage - UV, Overfrequency - OF, Underfrequency – UF) was considered. The combined NDZ values are arrived at through assessment of the region of non-operation of all of these protection functions.

It has been shown that ROCOF protection becomes very ineffective, especially with the proposed setting of 1 Hz/s with 500 ms time delay, in many islanding situations when considering 3s as a maximum LOM detection time. This is due to the observed frequency fluctuations with certain generation mixes. It is likely that this effect is caused by inverter controller interactions on PV and DFIG generators. One of the ways this effect can be mitigated is the reduction of the ROCOF relay time delay setting. However, further work would be required to arrive at the best compromise time delay figure.

The impact of the proposed setting change in terms of risks resulting from undetected islanded operation of DG can be considered as high, even if the absolute numbers are not accurate due to pessimistic assumptions. There is a significant difference (approximately two orders of magnitude) in the probability of undetected islanded operation between the existing recommended ROCOF settings and the considered new setting options. Some of the pessimistic assumptions of this study, such as the presence of voltage controllers on all generators, as well as the absence of network faults during the islanding incident, could have contributed to higher than expected risk results. The difference in risk between the considered future setting options 3 and 4 is approximately 50%. This is much smaller than the difference between the existing practice and the two considered future options 3 and 4.

Risk related to accidental electrocution (IR_E) for one of the proposed ROCOF settings (1 Hz/s with 500 ms time delay) is in the region of 10^{-7} , and therefore lies within what is termed as a broadly acceptable region according to the Health and Safety at Work Act 1974.

Under the proposed setting of 1 Hz/s with 500 ms time delay the rate of occurrence of out-of-phase auto-reclosing appears to be high (nearly 50 expected incidents p.a. compared to 0.13 p.a. under the existing setting of 0.125 Hz/s), and therefore, cannot be neglected. Further assessment of the anticipated costs and consequences of out-of-phase auto-reclosing to individual generating technologies is required to realistically assess the proportion of those incidents which would cause serious damage to the generator or endanger personnel. The presented final figures make no such distinction and assume that the majority (i.e. 80%) of all out-of-phase re-closures are damaging.

It is concluded, therefore, that with the proposed change of ROCOF settings to generators of less than 5 MW of installed capacity the calculated levels of risk to individuals can be seen as broadly acceptable, while the obtained high rates of out-of-phase auto-reclosures call for further investigation, and potentially application of other methods to limit the increase of the maximum ROCOF values in the UK transmission system.

2 Introduction

This report describes the outcomes of Phase II of the work conducted at the University of Strathclyde to assess the risks associated with the adjustment of ROCOF-based loss of mains (LOM) protection settings (through increasing or relaxing the settings, and therefore potentially compromising the sensitivity). The work has been commissioned by the Energy Networks Association (ENA) on behalf of the workgroup “Frequency changes during large system disturbances” (GC0079). The original high priority objectives for this work issued by ENA in April 2014 are included in Appendix D of this report.

As with Phase I of the work, the main objective of Phase II is to evaluate the risk to DNO network equipment and individuals (i.e. members of the public and/or personnel) associated with increasing the applied ROCOF protection settings (currently 0.125 Hz/s) to 0.5 Hz/s or 1 Hz/s. Both settings increases are also considered with an optional application of a ROCOF time delay of 500ms. Phase I, which was completed in June 2013, analysed generation capacities of between 5 MW and 50 MW [1], whereas this document presents the results of a similar assessment for distributed generation with capacities of less than 5 MW.

The report contains two main sections corresponding to work packages WP2 and WP3 as outlined in the proposal [3]:

- WP1 – Hardware testing based characterisation of DG
- WP2 – Simulation-based assessment of Non Detection Zone (NDZ): in this section, the NDZ is determined experimentally under varying ROCOF settings using transient Matlab-based simulations which include a power network model and a detailed model of an LOM protection relay validated against a commercial device through hardware testing [4].
- WP3 – Calculation of probability of specific hazards under various ROCOF settings: in this section, a generic NDZ/risk characteristic is established based on the obtained NDZ values, available load profiles, and a number of other assumptions which are explained fully in the report.

A separate report (ref. PNDC/ENA-001/FR-01) prepared by PNDC staff on WP1 contains the results of hardware testing of typical PV inverters.

2.1 Methodology

In order to meet the objectives outlined above, the work adopts a risk assessment methodology similar to that previously applied by the researchers at Strathclyde to verify the requirement for NVD protection [7][8] and also applied successfully in Phase I of this work [1]. The underlying assumptions and risk tree used in Phase II are tailored to the specifics of smaller generation capacities and to various islanding scenarios. The generic outline of this methodology is illustrated in Figure 1.

A number of assumptions are made with regards to the network configuration, including load representation, generation technology and associated control systems. These are used to experimentally (through transient simulation) determine the extent of any NDZ for the assumed ROCOF setting options. This is marked as “NDZ knowledge base” in Figure 1.

Furthermore, load profile data and annual fault statistics are utilised to estimate probabilities of islanding incidents and occurrences of balanced (or very-near-balanced) conditions between local

load and distributed generation output in the formed island prior to islanding occurring. This arrangement is used collectively to assess the risk of LOM non-detection with the aid of the developed risk tree.

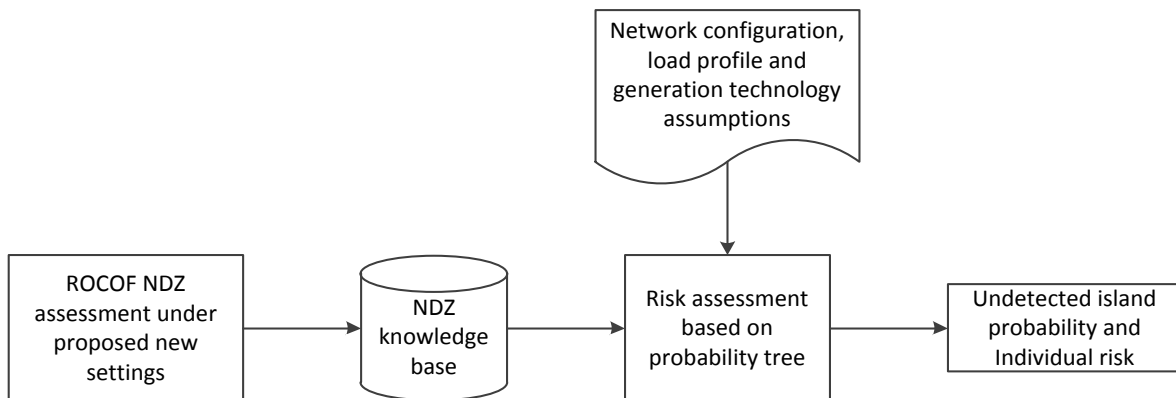

Figure 1. Risk assessment methodology

3 WP2 – Simulation based assessment of NDZ

This section describes the results and approach through which the NDZ has been determined experimentally for a range of ROCOF and G59 protection (OF, UF, OV, UV) settings. Three different generator technologies have been considered, including Synchronous Generator (SG), Photovoltaic Panels (PV) and Doubly-Fed Induction Generator (DFIG). Considering islanding of more than one generator, 12 different generation mixes have been considered which represent dominant generating groups across the UK distribution system. These dominant groups were established through detailed analysis of the DG connection registers made available to the project by the individual DNOs. The process of establishing the dominant groups is described in detail in section 4.2.2 of this report.

3.1 Network modelling

The network model used for the test is based on a reduced section of 11kV distribution network, representing a typical UK network. The network model is shown in Figure 2. The network and synchronous generator models were used previously to evaluate the performance of LOM protection and to recommend suitable settings in [1] and have been adapted for use in this study by adjusting the machine rating and tuning of controllers. The potentially-islanded section of the network incorporating the DG is connected through a Point of Common Coupling (PCC) to the main grid. An LOM condition is initiated by opening the circuit breaker at PCC. The measured voltage (from which frequency is derived) at busbar 'A' forms an input to the relay model under test. The network is modelled using Matlab/Simulink with SimPowerSystems toolbox. A model of a commercially-available DG interface relay commonly used in UK practice has been utilised in this test. The network parameters are detailed in Appendix A.

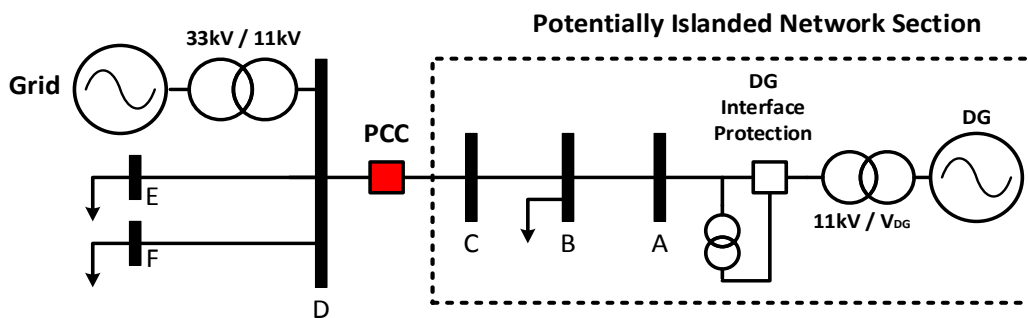

Figure 2. 11kV Test Network

3.2 DG Models and Controls

As previously mentioned, three different generator technologies have been included in the test programme, including SG, PV and DFIG. Different situations, including single generators and mixes of two and three different technologies, have been considered. For the purposes of the NDZ test the total installed capacity of the DG island is fixed at 2 MVA, while the rating of each generator is scaled up/down appropriately depending on the simulated mix. Each DG is connected to the grid through a step up transformer with unearthed HV winding to represent the typical DG connection arrangement in the UK.

3.2.1 Synchronous Generator

A synchronous machine with a power rating of 2 MVA is modelled as depicted in Figure 3. An active power and voltage (P-V) control scheme is employed for this machine. Generator parameters are detailed in Appendix A. A standard IEEE governor/turbine model is also used [5] (available in the SimPowerSystems component library). The block diagram for the excitation control is depicted in Figure 4. Controller parameters are detailed in Appendix A.

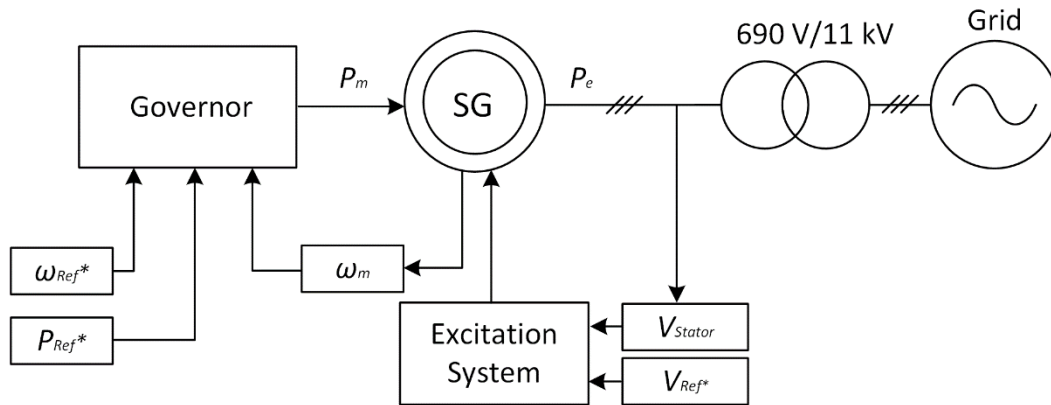

Figure 3. 11kV Synchronous Machine Model

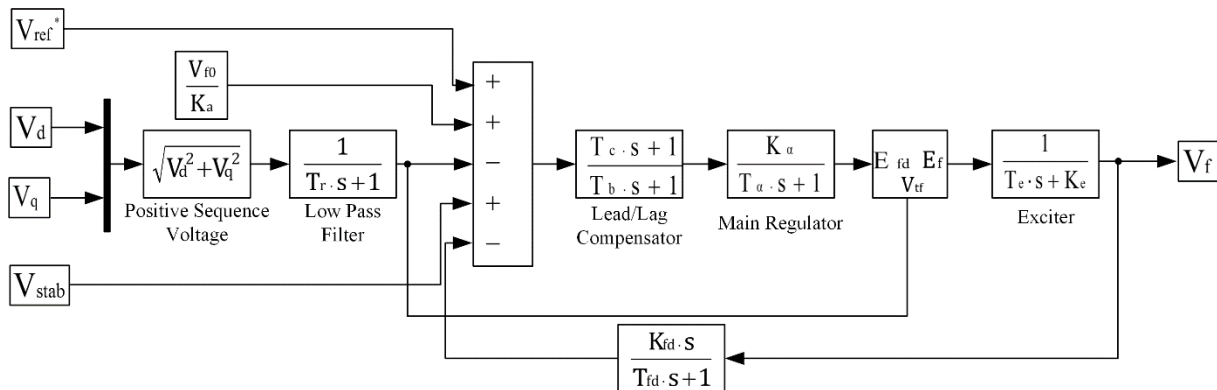

Figure 4. IEEE Type 1 Excitation System Block Diagram

3.2.2 Photovoltaic Panels (PV)

A PV park with a total capacity of 1.5 MVA (the size is adjusted for the purposes of different generation mixes) is modelled as shown in Figure 5. To represent solar panels the PV sources from the SimPowerSystems component library in Simulink have been used. PV panels are connected to the grid via a series of devices including a voltage boost converter, a three phase IGBT-based inverter, an RC filter and a power transformer. Maximum Power Point Tracking (MPPT) operation is integrated using the Perturb and Observe (P&O) algorithm [6]. Two controllers are integrated into the PV model. The first controls the DC voltage reference of the voltage boost converter by adjusting its duty cycle. The P&O algorithm is implemented within this controller. The second element controls the power flow and the three phase AC voltages. This is achieved by continuously adjusting the generated pulses through the use of Pulse Width Modulation (PWM). The parameters of the PV model are detailed in Appendix A.

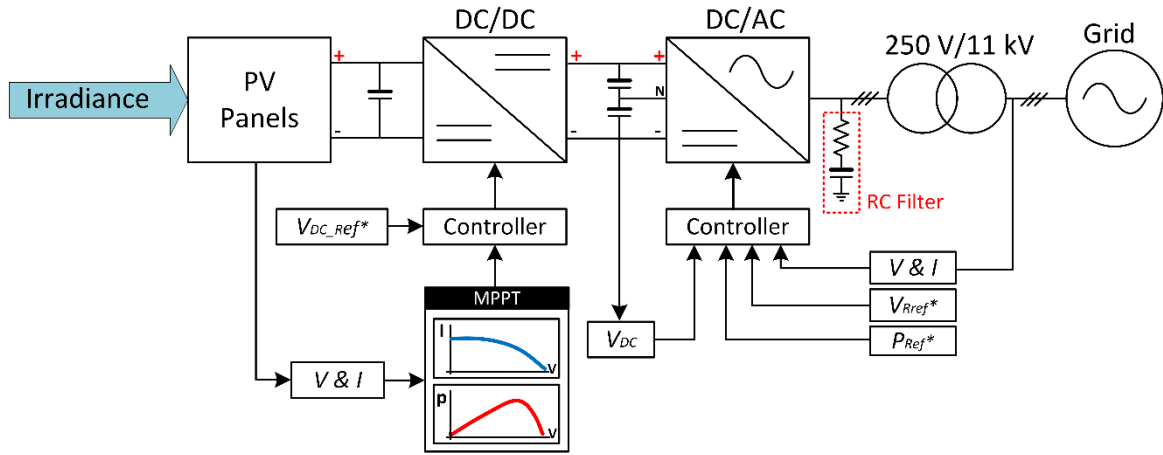

Figure 5. PV Model

3.2.3 Doubly fed induction generator

A DFIG with a maximum capacity of 2 MVA is modelled as shown in Figure 6. The DFIG consists of a wound-rotor induction generator, driven by a wind turbine and an AC/DC/AC IGBT-based PWM converter. The stator winding is connected through a transformer to the 11 kV 50 Hz grid, while the rotor is fed at variable frequency through the AC/DC/AC converter. The power converter offers the capability for variable speed operation while decoupled control of active and reactive power can be achieved.

Two controllers are utilised within the model. The Grid Side Converter (GSC) controller consists of an inner and outer control loop. The inner loop regulates the currents while the outer loop regulates the DC link voltage. The GSC operates at a fixed frequency (equal to the grid frequency) as it is connected directly to the grid. The main objective of the Rotor Side Converter (RSC) is to control the rotor currents which will define the torque produced by the DFIG. This is achieved by supplying the rotor with a voltage which corresponds to these currents. In order to control the output power of the DFIG, the GSC can use either a torque, a speed, or an active power controller. The parameters of the DFIG model are detailed in Appendix A.

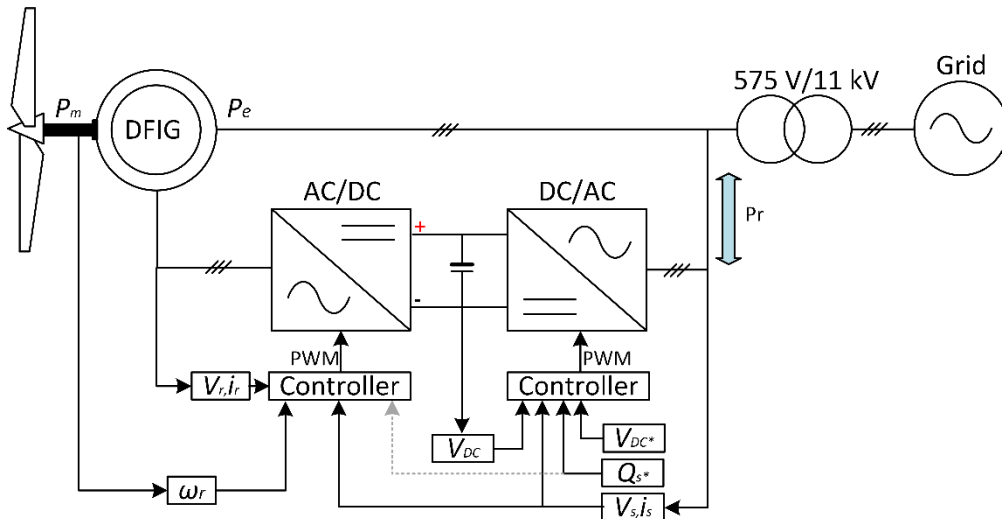

Figure 6. DFIG Model connected to 11kV Network

3.3 NDZ Evaluation

The objective of this experimental evaluation is to determine the non-detection zone (NDZ) of the ROCOF and G59 (OV, UV, OF, UF) protection as a percentage of DG MVA rating. The imbalance of active and reactive power through the point of common coupling (PCC) is adjusted independently to determine the NDZ.

A dynamic model of a commercially available DG interface relay commonly used in UK practice has been utilised in this test. The NDZ was assessed separately for the following protective functions:

- ROCOF with four different setting options as indicated in Table 1
- G59 protection including under and over voltage (OV, UV), and under and over frequency (OF, UF), with two stages according to most recent recommendations included in G59/3 [9] (refer to Table 2).

The tripping signal for each protection function is monitored separately to determine which functions (OV/UV/OF/UF/ROCOF) are activated for each test case and are recorded where appropriate.

Table 1. Assumed ROCOF setting options

Setting Option	ROCOF [Hz/s]	Time Delay [s]
1	0.13	0
2	0.2	0
3	0.5	0.5
4	1.0	0.5

Table 2. G59/3 Voltage and Frequency protection settings [9]

Voltage- Dependent		$V_{\Phi-\Phi}$ [%]	Time Delay [s]
Under Voltage	Stage 1	-13	2.5
	Stage 2	-20	0.5
Over Voltage	Stage 1	+10	1.0
	Stage 2	+13	0.5
Frequency Dependent		Frequency [Hz]	Time Delay [s]
Under Frequency	Stage 1	47.5	20
	Stage 2	47	0.5
Over Frequency	Stage 1	51.5	90
	Stage 2	52	0.5

3.3.1 Determining the NDZ

The NDZ was determined for both levels of pre-island active and reactive power imports and exports across the PCC. The imbalance of one type of power (e.g. active) is changed while holding the other type of power imbalance (e.g. reactive) at 0% by adjusting the local demand (and generator reactive power output if necessary). The power imbalance is expressed as a percentage of the DG rating. An automatic search routine developed specifically for this study was employed to iteratively change the power imbalances and monitor the relay trip response. With each incremental change in power imbalance across the PCC, the numerical relay model was injected with the simulated bus 'A' 3-phase voltages. The reported values of NDZ (considering separately power import and export) for active and reactive power are expressed according to the following equations (1).

$$\begin{aligned}
 NDZ_{PI} &= \frac{P_{PCCI}}{S_{DG}} \times 100\%, & NDZ_{PE} &= \frac{P_{PCCE}}{S_{DG}} \times 100\% \\
 NDZ_{QI} &= \frac{Q_{PCCI}}{S_{DG}} \times 100\%, & NDZ_{QE} &= \frac{Q_{PCCE}}{S_{DG}} \times 100\%
 \end{aligned} \tag{1}$$

Where:

NDZ_{PI}, NDZ_{PE} - Real power NDZ assessed for import and export respectively

NDZ_{QI}, NDZ_{QE} - Reactive power NDZ assessed for import and export respectively

P_{PCCI}, P_{PCCE} - Active power across the PCC defined separately for import and export

Q_{PCCI}, Q_{PCCE} - Reactive power across the PCC defined separately for import and export

S_{DG} - DG MVA Rating

The NDZ has been assessed for 12 different situations (termed here as generation mixes) which include single generators as well as combinations of two and three different technologies. The total rating is fixed at 2MVA for all 12 cases, as shown in Table 3.

Table 3. DG Technology Mixes

Grouping	Generation Mix	Generator Technology		
		Synchronous Generator	PV	DFIG
Single	1 (100% SG)	2 MVA	-	-
	2 (100% PV)	-	2 MVA	-
	3 (100% DFIG)	-	-	2 MVA
Groups of 2	4 (75% SG + 25% PV)	1.5 MVA	0.5 MVA	-
	5 (50% SG + 50% PV)	1 MVA	1 MVA	-
	6 (25% SG + 75% PV)	0.5 MVA	1.5 MVA	-
	7 (75% PV + 25% DFIG)	-	1.5 MVA	0.5 MVA
	8 (50% PV + 50% DFIG)	-	1 MVA	1 MVA
	9 (25% PV + 75% DFIG)	-	0.5 MVA	1.5 MVA
Groups of 3	10 (70% SG + 15% PV + 15% DFIG)	1.4 MVA	0.3 MVA	0.3 MVA
	11 (15% SG + 70% PV + 15% DFIG)	0.3 MVA	1.4 MVA	0.3 MVA
	12 (15% SG + 15% PV + 70% DFIG)	0.3 MVA	0.3 MVA	1.4 MVA

3.4 NDZ results

The combined NDZ results (with both ROCOF and G59 protection enabled) are summarised for all the 12 generation mixes in Tables 4 to 15. Values denoted by * indicate that G59 protection (combined operation of OF, UF, OV, and UF protection) has a narrower NDZ than the ROCOF protection (considering 3s as a maximum operation time). The values presented as zero indicate that at the given setting option it was not possible to achieve stable islanding operation for a period of at least 3s without ROCOF protection operation. The results in full detail are presented in Appendix B, where NDZ values are shown for ROCOF and G59 protection separately.

Table 4. Combined ROCOF-G59 NDZ results for generation mix 1 (100% SG)

Setting Option	NDZ_{PI} Import [%]	NDZ_{PE} Export [%]	NDZ_{QI} Import [%]	NDZ_{QE} Export [%]
1 (0.13Hz/s – 0s)	1.03	0.53	2.12	1.42
2 (0.2Hz/s – 0s)	1.03	0.78	2.45	1.92
3 (0.5Hz/s – 0.5s)	3.05	1.58	7.36	14.56
4 (1Hz/s – 0.5s)	5.85	3.14*	12.16*	23.67*

Table 5. Combined ROCOF-G59 NDZ results for generation mix 2 (100% PV)

Setting Option	NDZ_{PI} Import [%]	NDZ_{PE} Export [%]	NDZ_{QI} Import [%]	NDZ_{QE} Export [%]
1 (0.13Hz/s – 0s)	0	0	0	0
2 (0.2Hz/s – 0s)	0	0	0	0
3 (0.5Hz/s – 0.5s)	0.65*	0.87*	0.28*	0.43*
4 (1Hz/s – 0.5s)	0.65*	0.87*	0.28*	0.43*

Table 6. Combined ROCOF-G59 NDZ results for generation mix 3 (100% DFIG)

Setting Option	NDZ_{PI} Import [%]	NDZ_{PE} Export [%]	NDZ_{QI} Import [%]	NDZ_{QE} Export [%]
1 (0.13Hz/s – 0s)	0	0	0	0
2 (0.2Hz/s – 0s)	0	0	0	0
3 (0.5Hz/s – 0.5s)	0.83	1.44	4.68	2.29
4 (1Hz/s – 0.5s)	1.98	2.38	7.20	5.04

Table 7. Combined ROCOF-G59 NDZ results for generation mix 4 (75% SG + 25% PV)

Setting Option	NDZ_{PI} Import [%]	NDZ_{PE} Export [%]	NDZ_{QI} Import [%]	NDZ_{QE} Export [%]
1 (0.13Hz/s – 0s)	0.92	0.32	1.27	1.73
2 (0.2Hz/s – 0s)	0.92	0.32	1.99	1.9
3 (0.5Hz/s – 0.5s)	4.86	2.49*	8.65*	17.45*
4 (1Hz/s – 0.5s)	5.37*	2.49*	8.65*	17.45*

Table 8. Combined ROCOF-G59 NDZ results for generation mix 5 (50% SG + 50% PV)

Setting Option	<i>NDZ_{PI}</i> Import [%]	<i>NDZ_{PE}</i> Export [%]	<i>NDZ_{QI}</i> Import [%]	<i>NDZ_{QE}</i> Export [%]
1 (0.13Hz/s – 0s)	0	0	0	0
2 (0.2Hz/s – 0s)	0	0	0	0
3 (0.5Hz/s – 0.5s)	3.85*	1.66*	5.26*	11.23*
4 (1Hz/s – 0.5s)	3.85*	1.66*	5.26*	11.23*

Table 9. Combined ROCOF-G59 NDZ results for generation mix 6 (25% SG + 75% PV)

Setting Option	<i>NDZ_{PI}</i> Import [%]	<i>NDZ_{PE}</i> Export [%]	<i>NDZ_{QI}</i> Import [%]	<i>NDZ_{QE}</i> Export [%]
1 (0.13Hz/s – 0s)	0	0	0	0
2 (0.2Hz/s – 0s)	0	0	0	0
3 (0.5Hz/s – 0.5s)	2.43*	1.10*	2.31*	6.33*
4 (1Hz/s – 0.5s)	2.43*	1.10*	2.31*	6.33*

Table 10. Combined ROCOF-G59 NDZ results for generation mix 7 (75% PV + 25% DFIG)

Setting Option	<i>NDZ_{PI}</i> Import [%]	<i>NDZ_{PE}</i> Export [%]	<i>NDZ_{QI}</i> Import [%]	<i>NDZ_{QE}</i> Export [%]
1 (0.13Hz/s – 0s)	0	0	0	0
2 (0.2Hz/s – 0s)	0	0	0	0
3 (0.5Hz/s – 0.5s)	2.21*	0.47*	1.06*	2.59*
4 (1Hz/s – 0.5s)	2.21*	0.47*	1.06*	2.59*

Table 11. Combined ROCOF-G59 NDZ results for generation mix 8 (50% PV + 50% DFIG)

Setting Option	<i>NDZ_{PI}</i> Import [%]	<i>NDZ_{PE}</i> Export [%]	<i>NDZ_{QI}</i> Import [%]	<i>NDZ_{QE}</i> Export [%]
1 (0.13Hz/s – 0s)	0	0	0	0
2 (0.2Hz/s – 0s)	0	0	0	0
3 (0.5Hz/s – 0.5s)	20.08*	1.08*	2.69*	4.83*
4 (1Hz/s – 0.5s)	20.08*	1.08*	2.69*	4.83*

Table 12. Combined ROCOF-G59 NDZ results for generation mix 9 (25% PV + 75% DFIG)

Setting Option	<i>NDZ_{PI}</i> Import [%]	<i>NDZ_{PE}</i> Export [%]	<i>NDZ_{QI}</i> Import [%]	<i>NDZ_{QE}</i> Export [%]
1 (0.13Hz/s – 0s)	0	0	0	0
2 (0.2Hz/s – 0s)	0	0	0	0
3 (0.5Hz/s – 0.5s)	6.11*	1.77*	5.41*	7.02*
4 (1Hz/s – 0.5s)	6.11*	1.77*	5.41*	7.02*

Table 13. Combined ROCOF-G59 NDZ results for generation mix 10 (70% PV + 15% PV + 15% DFIG)

Setting Option	<i>NDZ_{PI}</i> Import [%]	<i>NDZ_{PE}</i> Export [%]	<i>NDZ_{QI}</i> Import [%]	<i>NDZ_{QE}</i> Export [%]
1 (0.13Hz/s – 0s)	0.34	0.41	1.57	1.39
2 (0.2Hz/s – 0s)	0.60	0.41	2.01	2.16
3 (0.5Hz/s – 0.5s)	5.23*	2.18	9.69	19.24*
4 (1Hz/s – 0.5s)	5.23*	2.45*	10.14*	19.24*

Table 14. Combined ROCOF-G59 NDZ results for generation mix 11 (15% PV + 70% PV + 15% DFIG)

Setting Option	<i>NDZ_{PI}</i> Import [%]	<i>NDZ_{PE}</i> Export [%]	<i>NDZ_{QI}</i> Import [%]	<i>NDZ_{QE}</i> Export [%]
1 (0.13Hz/s – 0s)	0	0	0	0
2 (0.2Hz/s – 0s)	0	0	0	0
3 (0.5Hz/s – 0.5s)	2.60*	0.93*	2.77*	6.44*
4 (1Hz/s – 0.5s)	2.60*	0.93*	2.77*	6.44*

Table 15. Combined ROCOF-G59 NDZ results for generation mix 12 (15% PV + 15% PV + 70% DFIG)

Setting Option	<i>NDZ_{PI}</i> Import [%]	<i>NDZ_{PE}</i> Export [%]	<i>NDZ_{QI}</i> Import [%]	<i>NDZ_{QE}</i> Export [%]
1 (0.13Hz/s – 0s)	0	0	0	0
2 (0.2Hz/s – 0s)	0	0	0	0
3 (0.5Hz/s – 0.5s)	3.80*	2.29*	7.52	12.78*
4 (1Hz/s – 0.5s)	3.80*	2.29*	8.93*	12.78*

From tables 4-15 it can be observed that:

- For setting options 1 and 2 ROCOF protection has narrower NDZ than G59 protection (OF,UF,OV,UV) in 100% of the cases (48 out of 48).
- For setting option 3 ROCOF protection has narrower NDZ than G59 protection (OF,UF,OV,UV) in 18.75% of the cases (9 out of 48).
- For setting option 4 ROCOF protection has narrower NDZ than G59 protection (OF,UF,OV,UV) in 4% of the cases (2 out of 48).

By analysing the tables presented in Appendix B it can be seen that for setting options 3 and 4, the NDZ is relatively wide in many cases. As the power imbalances of up to 50% have been considered only, in the extreme cases where no operation was encountered up to this level the NDZ is indicated as “>50%”, i.e. NDZ is wider than 50%. The reason for such poor ROCOF performance can be seen in Figure 7 and Figure 8 where the frequency and ROCOF response are depicted for generation mix 7 (75% PV + 25% DFIG). In particular, Figure 7 represents the system response for 25% active power import across the PCC, while in Figure 8 the local network exports 15% reactive power prior to LOM.

In both cases following the LOM event the frequency drifts away from the nominal value, but at the same time, becomes oscillatory. This leads to an oscillatory ROCOF response with frequent zero crossings. With the application of sufficient time delay the relay resets at every zero crossing before the delay is elapsed, and hence, no tripping is present. This apparent lack of response from the relay can be observed when the proposed time delay setting of 500ms is applied. To investigate this further experimentally, a reduced time delay of 200ms (maintaining the ROCOF threshold at 1.0 Hz/s) was applied which successfully initiated a tripping signal for both example cases depicted in Figures 7 and 8. While the investigation of optimal time delay is beyond the scope of this work it has been demonstrated that the time delay setting can have a significant impact on the width of the NDZ, and therefore, on the resulting risk level of undetected LOM. This may require future work and can be considered by the ENA and the appropriate panel members.

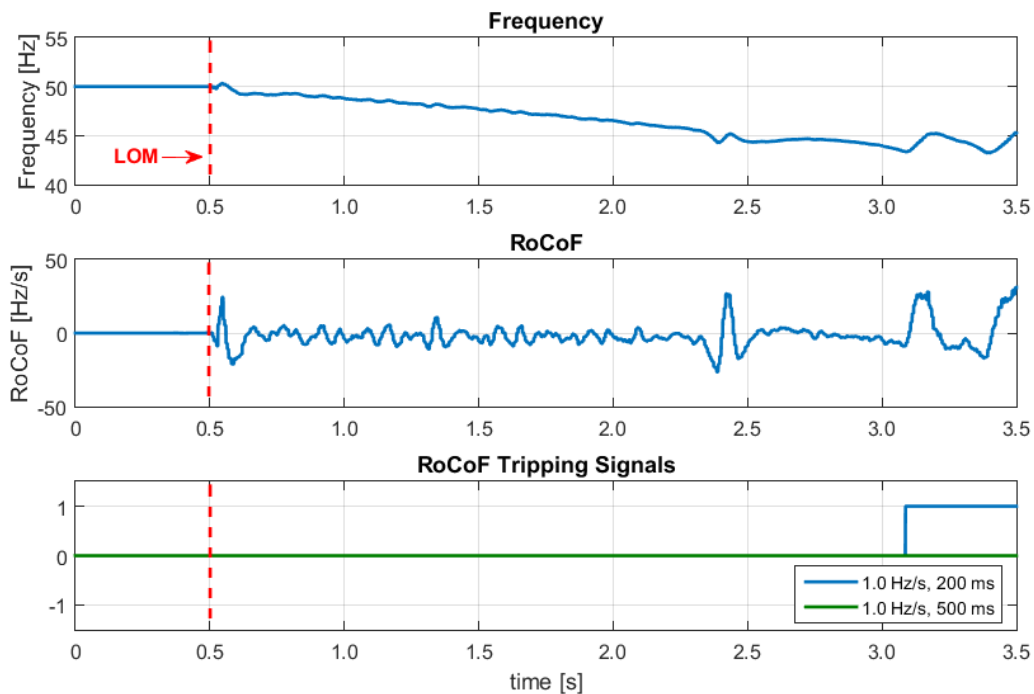

Figure 7. Islanded system response for generation mix 7 (75% PV + 25% DFIG) – 25% active power import

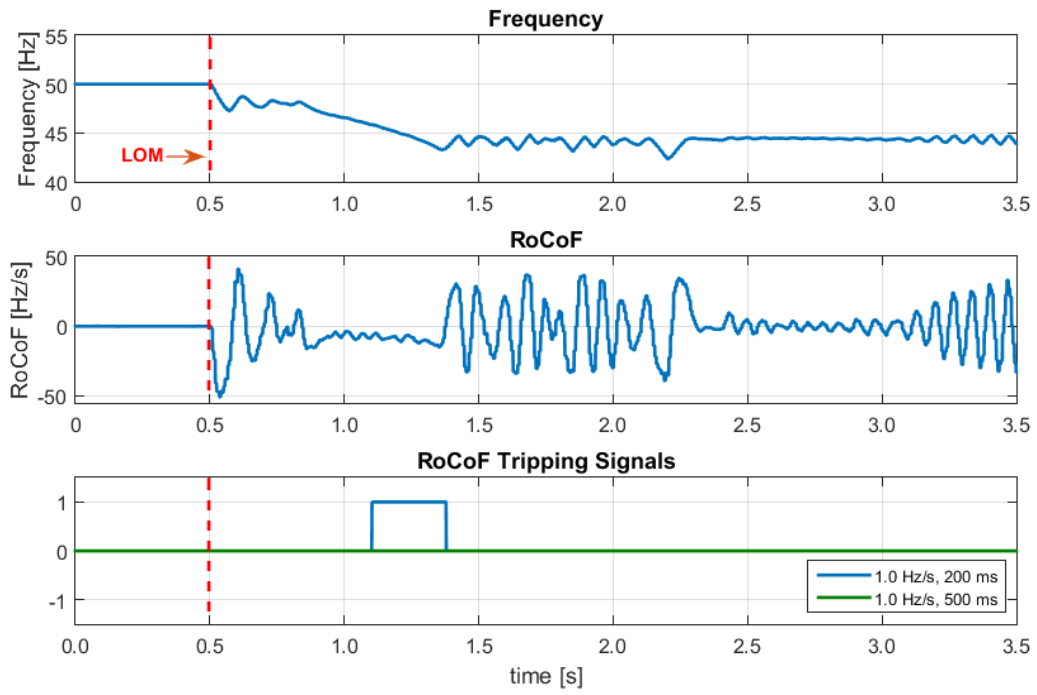

Figure 8. Islanded system response for generation mix 7 (75% PV + 25% DFIG) – 15% reactive power export

4 WP3 – Risk level calculation at varying NDZ

4.1 Risk Calculation Methodology

The risk calculation methodology adopted in this work is similar to the method previously applied in Phase I of this work [1]. This approach is based on a statistical analysis of a probability tree depicting perceived probability of specific hazards (including safety of people or damage to equipment).

The methodology makes a number of assumptions regarding the type of utility network, type and size of the distributed generators and generation technology (refer to section 4.2 for details). It utilises the width of the Non Detection Zone (NDZ) established through detailed dynamic simulation described earlier in section 3 of this document (WP2). Recorded typical utility load profiles, generation profiles, as well as statistics of utility network incidents including loss of supply to primary substations and short term interruptions are also utilised to estimate probabilities of islanding incidents and load-generation matching.

Additionally, detailed DG connection registers (provided by a number of DNOs) were utilised to establish the predominant types of generation mixes in the identified typical islanding situations. Assuming that the fault tree as presented in Figure 9 is used, the calculations, described in the following sub-sections, are performed to assess:

- personal safety hazard (the term Individual Risk IR_E is used in this report to denote the annual probability of death resulting from an undetected LOM condition), and
- damage to generator occurring as a result of sustained undetected islanded operation of DG combined with likely out-of-phase auto-reclosure (the annual rate of occurrence of out-of-phase auto-reclosure N_{OA} is used in this report).

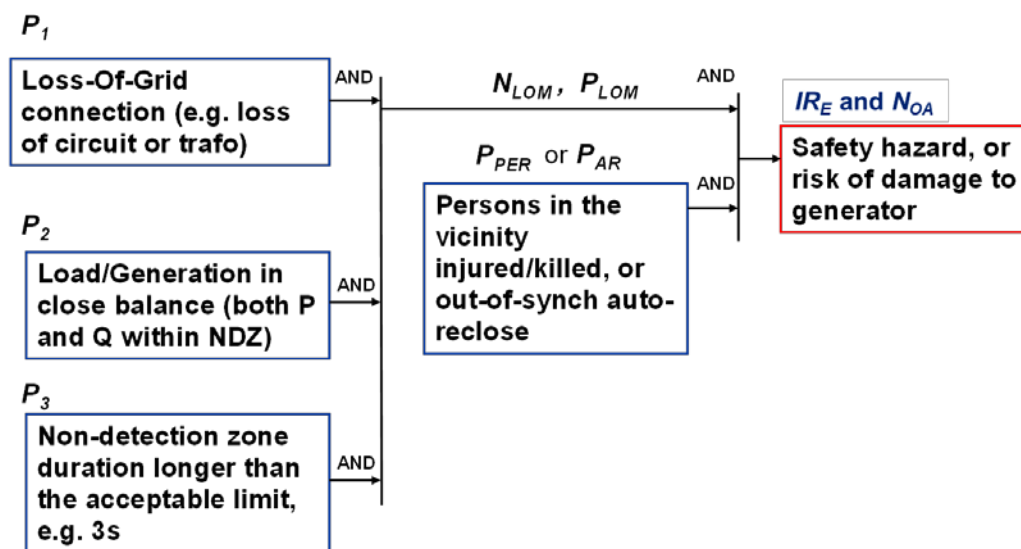

Figure 9. LOM Safety Hazard Probability Tree

Due to the variety of islanding scenarios (section 4.2.1), in conjunction with the range of possible different generation mixes (section 4.2.1), the risk tree calculation is systematically repeated through all combinations of islanding situations and the final probability figures are obtained as a sum or weighted average of the individual results. The following subsections explain this process in detail.

4.1.1 Expected number of LOM occurrences in a single islanding point

For a single islanding point (whether an entire substation or an individual circuit), the possibility of an undetected islanding situation arises from the loss of grid supply. Accordingly, the expected number of incidents of losing supply to an individual islanding point ($N_{LOG,1IP}$) during the period of one year can be estimated as follows:

$$N_{LOG,1IP} = \frac{n_{LOG}}{n_{IP} \cdot T_{LOG}} \quad (2)$$

where n_{LOG} is the total number of loss of supply incidents experienced during the period of T_{LOG} in a population of n_{IP} islanding points. The assumed values of n_{LOG} and n_{IP} for each islanding scenario have been derived from the network incident statistics, as described in section 4.2.1.

4.1.2 Load and generation profile analysis

For each generation mix and each islanding scenario $m = 1, 2, \dots, 21$ (12 mixes in scenario 1 and 9 mixes in scenario 2 = 21 cases) the probabilities $P_{2(m)}$ and $P_{3(m)}$ (refer to Figure 9) are calculated jointly by systematic analysis of the example recorded load and generation profiles recorded over a period of 1 week with 1s resolution. This is performed iteratively in two nested loops. The inner loop (iteration i) progresses through the whole duration of the given record, while the outer loop (iteration j) covers the range of generation mix capacities according to the histogram characteristic of the given mix of technologies. The histograms for all predominant generation mixes are derived from the available DG connection registers as described in section 4.2.1. In each capacity band j there is a certain number of islanding points $n_{IP(m,j)}$. It should be noted that generator maximum output and generator rating are synonymous in the context of this calculation.

Within the inner loop at each time step (iteration i), the instantaneous load values $P_{L(i)}$ and $Q_{L(i)}$ are compared with the scaled version of the generation profile ($P_{DGG(m,j,i)}$ and $Q_{DGG(m,j,i)}$) to check if the difference falls within the NDZ established for the specific generation mix. This condition is described by (3).

$$\begin{aligned} -NDZ_{PE(m)} < P_{L(i)} - P_{DGG(m,j,i)} < NDZ_{PI(m)} \\ \wedge \\ -NDZ_{QE(m)} < Q_{L(i)} - Q_{DGG(m,j,i)} < NDZ_{QI(m)} \end{aligned} \quad (3)$$

Where:

- $P_{L(i)}, Q_{L(i)}$ - recorded samples of active and reactive load power
- $P_{DGG(m,j,i)}, Q_{DGG(m,j,i)}$ - scaled active and reactive generation profile for the generation mix m and capacity band j
- $NDZ_{PE(m)}, NDZ_{QE(m)}$ - NDZ when generator output is higher than the local load (export) for generation mix m
- $NDZ_{PI(m)}, NDZ_{QI(m)}$ - NDZ when generator output is lower than the local load (import) for generation mix m

When consecutive samples conform to the conditions specified in equation (3), the time is accumulated until the local load exits the NDZ. After all NDZ instances (i.e. their durations) are recorded, the NDZ duration cumulative distribution function (CDF) is derived, an example of which is presented in Figure 10. As illustrated in the figure, the probability $P_{3(m,j)}$ that the NDZ is longer than T_{NDZmax} can easily be obtained from the CDF.

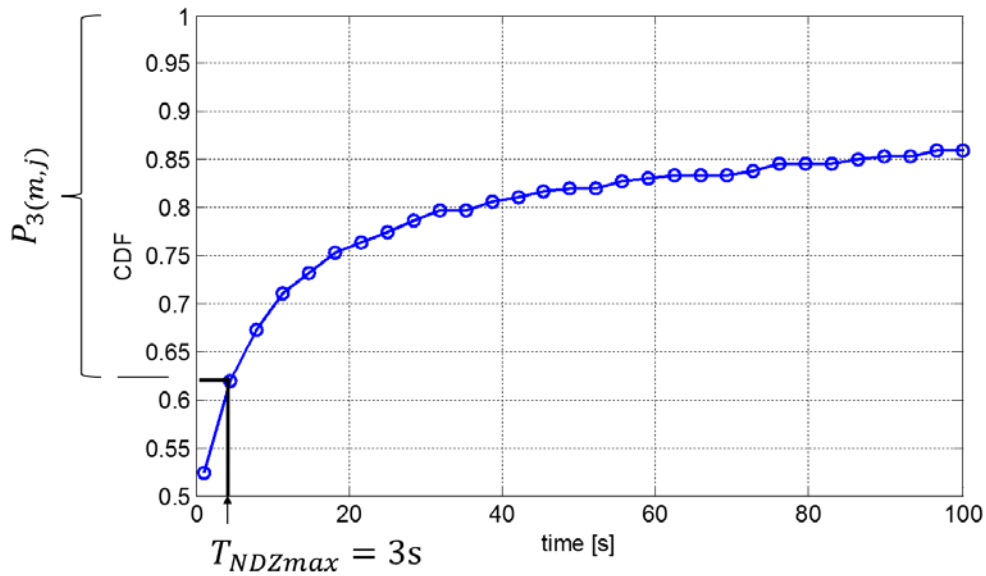

Figure 10. CDF of an example NDZ duration time

At the same time, the probability $P_{2(m,j)}$ of both P and Q being within the NDZ is also calculated as a sum of all recorded NDZ periods with respect to the total length of the recorded load profile (4).

$$P_{2(j)} = \sum_{k=1}^{n_{NDZ(m,j)}} \frac{T_{NDZ(m,j,k)}}{T_{load_record}} \quad (4)$$

Where:

- $n_{NDZ(m,j)}$ - number of detected NDZ periods within the capacity band j
- T_{load_record} - total length of the recorded load profile
- $T_{NDZ(m,j,k)}$ - length of k -th NDZ period.

Finally, the joint probability $P_{23(m,j)}$ for each capacity band j can be calculated as (5) which leads to the development of the probability density as shown in Figure 11.

$$P_{23(m,j)} = \frac{n_{DGG(m,j)}}{n_{DGG(m)}} P_{2(m,j)} \cdot P_{3(m,j)} \quad (5)$$

where:

- $n_{DGG(m,j)}$ - number of DG islanding groups in the mix m and the capacity band j
- $n_{DGG(m)}$ - total number of DG groups in the generation mix m

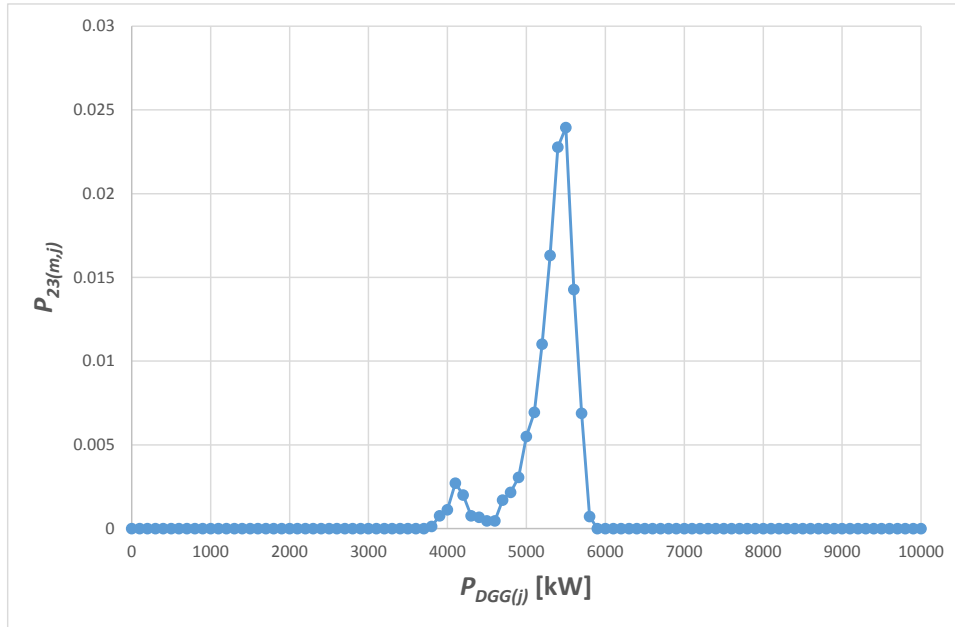

Figure 11. Non-detection zone probability at varying DG group capacity

Consequently, according to the principle of marginal probability [12], the combined probability $P_{23(m)}$, considering all DG groups of certain mix, is calculated using a simple summation as shown in (6).

$$P_{23(m)} = \sum_{j=1}^{n_{CB(m)}} P_{23(m,j)} \quad (6)$$

Where $n_{CB(m)}$ is the number of capacity bands.

The expected annual number of undetected islanding operations longer than the assumed maximum period T_{NDZmax} for an individual DG mix can be calculated as (7).

$$N_{LOM,1DGG(m)} = N_{LOG,1IP} \cdot P_{23(m)} \quad (7)$$

Additionally, the overall average duration of the NDZ for a given mix ($T_{NDZavr(m)}$) is calculated by adding all NDZ durations longer than T_{NDZmax} from all generator groups and dividing the sum by the total number of NDZ occurrences.

The above process described by equations (3)-(7) is repeated for all considered 21 islanding cases. The final figures of T_{NDZavr} are calculated as a weighted average (8) from all different generation mixes and islanding scenarios ($m = 1,2, \dots, 12$ for scenarios 1 and $m = 13,14, \dots, 21$ for scenario 2).

$$T_{NDZavr,s1} = \frac{\sum_{m=1}^{12} n_{DGG(m)} \cdot T_{NDZavr(m)}}{\sum_{m=1}^{12} n_{DGG(m)}}$$

$$T_{NDZavr,s2} = \frac{\sum_{m=13}^{21} n_{DGG(m)} \cdot T_{NDZavr(m)}}{\sum_{m=13}^{21} n_{DGG(m)}} \quad (8)$$

$$T_{NDZavr} = \frac{\sum_{m=1}^{21} n_{DGG(m)} \cdot T_{NDZavr(m)}}{\sum_{m=1}^{21} n_{DGG(m)}}$$

4.1.3 Calculation of national LOM probability figures and individual risk

In each case of generation mix m the expected annual number of undetected LOM events $N_{LOM(m)}$ and the probability of an undetected islanded system at any given time $P_{LOM(m)}$ are established. Firstly, using the known total number of connected DG groups ($n_{DGG(m)}$) with an assumed proportion of ROCOF based LOM protection ($p_{ROCOF(m)}$) and load factor ($LF(m)$), the expected annual number of undetected islanding incidents (within mainland UK) can be estimated from:

$$N_{LOM(m)} = N_{LOM,1DG(m)} \cdot n_{DGG(m)} \cdot p_{ROCOF(m)} \cdot LF(m) \quad (9)$$

The expected cumulative time of undetected islanding conditions for all considered DG groups $n_{DGG(m)}$ in mix m can be estimated using:

$$T_{LOM(m)} = N_{LOM(m)} \cdot (T_{LOMavr(m)} - T_{NDZmax}) \quad (10)$$

where $T_{LOMavr(m)}$ is the average time that an undetected island can be sustained in mix m . This time is selected as the minimum value between $T_{NDZavr(m)}$ and assumed maximum operation time of the auto-reclosing scheme (T_{ARmax}). It is assumed that sustained islanded operation following an auto-reclose operation is not possible.

Finally, the overall probability in mix m of an undetected islanded system at any given time and at specific assumed ROCOF settings is calculated as:

$$P_{LOM(m)} = \frac{T_{LOM(m)}}{T_a} \quad (11)$$

Where:

T_a – period of 1 year

The final figures of P_{LOM} are calculated as a direct sum of probabilities obtained for individual generation mixes ($m = 1,2, \dots, 12$ for scenarios 1 and $m = 13,14, \dots, 21$ for scenario 2).

$$P_{LOM,s1} = \sum_{m=1}^{12} P_{LOM(m)}$$

$$P_{LOM,s2} = \sum_{m=13}^{21} P_{LOM(m)} \quad (12)$$

$$P_{LOM} = \sum_{m=1}^{21} P_{LOM(m)}$$

For a single DG group with ROCOF protection in mix m , the probability can be calculated as:

$$P_{LOM,1DGG(m)} = \frac{P_{LOM(m)}}{n_{DGG(m)} \cdot p_{ROCOF(m)}} \quad (13)$$

In this case the final figures of $P_{LOM,DGG}$ are calculated as a weighted average (proportional to the number of DG groups) from all different generation mixes and islanding scenarios ($m = 1,2, \dots, 12$ for scenarios 1 and $m = 13,14, \dots, 21$ for scenario 2).

$$P_{LOM,1DGG,s1} = \frac{\sum_{m=1}^{12} n_{DGG(m)} \cdot P_{LOM,1DGG(m)}}{\sum_{m=1}^{12} n_{DGG(m)}}$$

$$P_{LOM,1DGG,s2} = \frac{\sum_{m=13}^{21} n_{DGG(m)} \cdot P_{LOM,1DGG(m)}}{\sum_{m=13}^{21} n_{DGG(m)}} \quad (14)$$

$$P_{LOM,1DGG} = \frac{\sum_{m=1}^{21} n_{DGG(m)} \cdot P_{LOM,1DGG(m)}}{\sum_{m=1}^{21} n_{DGG(m)}}$$

In order to ascertain whether the risk resulting from the proposed adjustment to the ROCOF settings is acceptable, the analysis and interpretation of the calculated N_{LOM} and P_{LOM} values is performed in two steps:

1. Firstly, the annual expected number of out-of-phase auto-reclosures (N_{OA}) during the islanding condition (undetected by LOM protection) is calculated as follows:

$$N_{OA} = N_{LOM} \cdot P_{AR} \quad (15)$$

where P_{AR} is the probability of an out-of-phase auto-reclosing action following the disconnection of a circuit supplying a primary substation. Considering that auto-reclosing action would occur in the vast majority of cases of losing supply to a primary substation (unless the system is wholly underground) and also considering the fact that reclosure with small angle differences may be safe, a value of $P_{AR} = 0.8$ was assumed.

2. Secondly, the annual probability values are calculated related to perceived Individual Risk (IR). Two sources of IR are considered: (a) the risk of a fatality due to accidental contact with any elements of the energised undetected island (IR_E), and (b) risk of physical injury or death resulting from the generator destruction following an out-of-phase auto-reclosure (IR_{AR}). These two indices are calculated as follows:

$$IR_E = P_{LOM} \cdot P_{PER,E} \quad (16)$$

$$IR_{AR} = N_{OA} \cdot P_{PER,G} \quad (17)$$

where $P_{PER,E}$ is the probability of a person in close proximity to an undetected islanded part of the system being killed, and $P_{PER,G}$ is the probability of a person being in close proximity of the generator while in operation and suffering fatal injury as a result of the generator being destroyed by an out-of-phase auto-reclosure. The resulting IR can be then compared with the general criteria for risk tolerability included in the Health and Safety at Work Act 1974 which adopts the risk management principle often referred to as the 'ALARP' or 'As Low as Reasonably Practicable' principle. The ALARP region applies for IR levels between 10^{-6} and 10^{-4} . Risks with probabilities below 10^{-6} can generally be deemed as tolerable. A similar approach has already been used in the risk assessment of NVD protection requirement [7][8]

and in Phase I of this work [1] where the value of $P_{PER,E} = 10^{-2}$ was used. However, the probability $P_{PER,G}$ will depend on specific circumstances, generator location and regime of operation, and therefore, it is beyond the scope of this report to quantify such probabilities.

The relative difference in the probability of undetected islanding condition under the existing recommended settings and the new proposed settings provides further guidance as to the acceptability of the proposed setting options.

4.2 Initial assumptions and available data

The following assumptions and initial values were made in this study:

- Generation range considered 0-5MW;
- Generation output is represented by an example measured generation profile characteristic of a particular generation technology, with the exception of synchronous generator which is represented by constant output equal to the rated power of the machine, with the output assumed to be generated at a power factor of $pf = 0.99$ (*lagging*). Sample generation profiles for wind and PV generation recorded with 5s sampling resolution were provided as input to this work by SSE. Also, one example synchronous generator profile was provided by ScottishPower Manweb (SPM) in Phase I of this work.
- For generation other than synchronous the load factor (LF) is accounted for by the application the specific weekly generation profiles, and is therefore, assumed to be 1 in equation (9). For example, referring to solar generation profile in Figure 22b it can be seen that the generation output is zero during the night which is equivalent to generator being off. However, for synchronous type generation, due to the used constant output (i.e. not including the periods when it is disconnected), the load factor in (9) is assumed to be $2/3$ (similar to the value used in Phase I of the work).
- Based on the assessment of the types of LOM protection currently used in UK performed by ECOFYS and published in the final report [10], for the purposes of this study it was assumed that the usage of ROCOF protection is 80%, 50% and 10% for Synchronous, DFIG and PV based generation respectively. From the same study it is also evident that there is no evidence of ROCOF being used in the UK at LV level.
- Detailed distribution of DG sizes and numbers in the UK were obtained from available DG connection registers for the following DNOs: WPD, ENW, UKPN, SPD and NPG.
- Six different load scenarios recorded on typical 11kV and LV feeders in the UK were used as described in section 4.2.4.
- A period of $T_{NDZmax} = 3s$ was assumed as the maximum permissible duration of undetected islanding condition (i.e. no auto-reclosing faster than T_{NDZmax} is expected to occur).
- A period of $T_{ARmax} = 20s$ was assumed as the maximum expected time of operation of the auto-reclosing scheme (in other words, regardless of load/generation balance, undetected stable island will not continue to operate longer than T_{ARmax} due to the impact of out-of-phase reclosure).
- It is assumed that the generator (or a group of generators) does not continue to supply the system after an out-of-phase auto-reclosing operation.
- The LOM event is simulated as a simple opening of a circuit breaker at the point of common coupling and no initiating fault is simulated prior to islanding.

4.2.1 Potential islanding scenarios and estimated frequency of occurrence

Generation below 5MW can be connected either at LV (0.4kV) or HV (11kV) voltage level. There are a few different scenarios which can lead to power islanding of one or more generating units. For the purposes of Phase II, four different scenarios were initially considered as illustrated in Figure 12. Based on the assumed absence of dedicated ROCOF protection at LV level it was considered appropriate to disregard scenarios 3 and 4 as having no impact on the risk levels during the proposed change of settings.

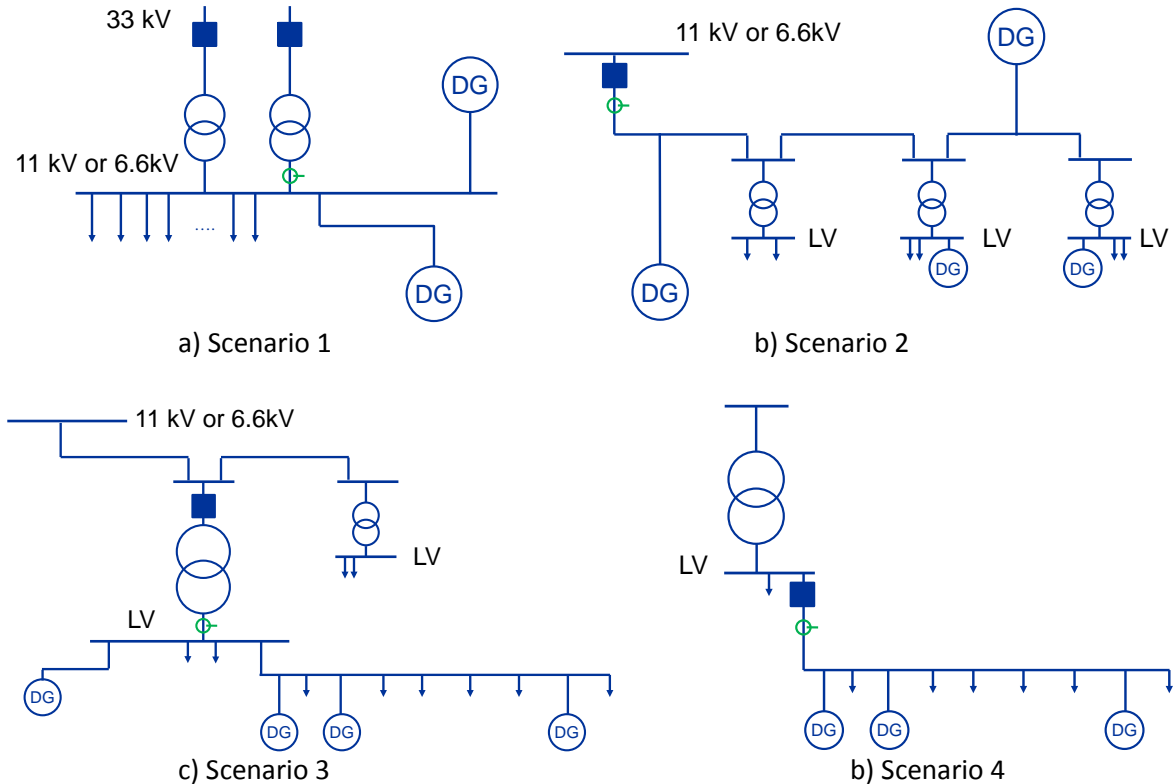

Figure 12. Potential islanding scenarios

Scenario 1 considers the loss of grid supply to primary substation or supply point which is similar to the islanding scenario considered in Phase I of this work. Therefore, to assess the expected annual number of LOM occurrences the following primary substation incident records (including short duration interruptions) were used:

- ENW – in a population of 440 substations there were 96 loss of supply incidents over a period of 7 years,
- Northern Powergrid – in a population of 613 substations (including supply point sites) there were 258 loss of supply incidents over a period of 10 years.

The combined figures were used to calculate expected annual number of LOM occurrences in a single substation according to equation (2) ($N_{LOG,1IP,s1} = 0.0375$).

Scenario 2 considers the disconnection of an individual 11kV feeder, usually due to a short-circuit fault. As a result an islanding of DG (connected to the same feeder) can occur. In particular, single phase to earth faults, after being cleared from the substation side, will no longer be seen by the generator which typically connects to the HV system through a star/delta step-up transformer. In such cases G59 or LOM protection will be responsible for de-energising the islanded part of the network. It is assumed, therefore, that only single phase to earth faults pose a potential hazard related to islanding condition. The majority of other types of faults should be detected by the

generator overcurrent protection. In order to establish the expected number of network incidents which may potentially lead to islanding various network statistics provided by individual DNOs have been used. The relevant data have been extracted from the individual DNO's records and summarised in Table 16. As a complete set of statistics was not available, the number of HV feeders as well as data relating to short-term interruptions for some of the DNOs had to be estimated (indicated by the shaded cells in the table) assuming that these figures were proportional to the number of primary substations in a given DNO area.

Table 16. Distribution network data and incident statistics

DNO	No of Primary Subs	No of 11kV feeders	HV incidents p.a. (2012/13)	Short interruptions p.a. (2013/14)	All incidents p.a.
WPD_WMID	240	2870	2840	3564	6404
WPD_EMID	493	3480	2089	7321	9410
ENWL	415	2905	2269	6163	8432
NPG_N	191	1337	1868	3468	5336
NPG_Y	422	2954	1727	5635	7362
WPD_SWales	262	1840	1752	3891	5643
WPD_SWest	478	2380	2765	7098	9863
UKPN_LPN	66	462	718	980	1698
UKPN_SPN	367	2569	2208	5450	7658
UKPN_EPN	532	3724	3236	7900	11136
SP_SPD	399	2793	2269	5925	8194
SP_SPM	674	4718	2513	10009	12522
SSE_SHEPD	476	3332	2319	7069	9388
SSE_SEPD	548	3836	2738	8138	10876
Total:	5563	39200	31311	82610	113921

Assuming that single phase to earth faults cause 90% of all network interruptions the expected annual number of incidents leading to islanded situation in a single feeder can be calculated from (2)

$$\text{as: } N_{LOG,1IP,s2} = \frac{n_{LOG}}{n_{IP} \cdot T_{LOG}} = \frac{0.9 \times 113921}{39200 \times 1} = 2.6155$$

For the purposes of scenario 2 it was estimated (based on the numbers of HV circuit breakers provided for WPD, refer to Table 16) that on average there are 7 feeders supplied from a single primary substation, i.e. $\frac{2870+3480+1840+2380}{240+493+262+478} = 7.18$.

4.2.2 DG connection register analysis

Available registers of the UK-installed DG with capacities of less than 5MW have been utilised to ascertain the most dominant generation mixes in the UK for both assumed islanding scenarios 1 and 2. The registers were available (provided directly by the workgroup members) for the following DNOs: WPD, ENW, NPG, UKPN and SPD. For WPD the DG capacity register is available online [11].

Due to the very large number of connections, variety of technologies and numerous potential generation mixes in different islanding scenarios the data was initially pre-processed as follows:

All generation types included in the available registers were mapped into 5 main generating technologies as follows outlined in Table 17.

Table 17. Generation technology mapping

Generation type reported in the register	Assumed generating technology
Hydro	Asynchronous
HY	
Hydro run-of-river and poundage	
Hydro water reservoir	
Onshore Wind	DFIG
WD	
HV GEN INTERMITTENT POST APR05	
HV GEN NON-INT PRE APR 05	
Onshore wind	
Wind onshore	
Wind Onshore	Inverter Connected
Photovoltaic	
PV	
LV GEN INTERMITTENT POST APR05	
PV & WIND	
Solar	
Offshore Wind	Permanent Magnet SG
Wind offshore	
Biomass & Energy Crops (not CHP)	Synchronous
Landfill Gas Sewage Gas Biogas (not CHP)	
Large CHP (>=50mw)	
Medium CHP (>5MW <50MW)	
Micro CHP (Domestic)	
Mini CHP (<1MW)	
Other Generation	
Small CHP (>1MW <5MW)	
Waste Incineration (not CHP)	
Not known	
Micro CHP	
CHP	
CiC	
Diesel	
Gas	
STOR	
Storage	
Waste	
Biomass & energy crops (not CHP)	
Landfill gas, sewage gas, biogas (not CHP)	
Small CHP (>=1MW, <5MW)	
Micro CHP (domestic)	
Other generation	
Waste incineration (not CHP)	
Biomass	
Fossil coal-derived gas	
Fossil gas	
Fossil hard coal	
Fossil oil	
Other	
Other renewable	
Steam	

1. At each primary substation the technologies with a cumulative contribution of 10% or less were removed from the mix and the remaining generation was scaled up to the full capacity of the installed generation at that substation.
2. For the purposes of scenario 2 all generation was distributed among the individual HV feeders connected to the primary. It was assumed that due to their large numbers PV generation was evenly distributed among HV feeders (assumed seven feeders per substation). Conversely, non-PV technologies were connected to a single feeder due to the relatively much smaller population and through assuming that the probability of more than one generator being on the same feeder is low. An additional rule was also introduced to split non-PV generation into separate feeders when its total capacity exceeded 5MW as no single generator greater than 5MW was included in the DG register.
3. Each of the two registers (one for each islanding scenario) was then analysed to identify the dominant mixes of islanding groups. The outcome of this analysis is presented in Figure 13 for islanding scenario 1 and Figure 14 for scenario 2. The cut-off threshold of 3% for scenario 1 and 2% for scenario 2 was used to establish the dominant groups, i.e. the groups with populations lesser than the threshold were removed from the analysis. The dominant groups are indicated in blue colour in the aforementioned figures. The highlighted six dominant mixes in scenario 1 and five mixes in scenario 2 were included in further analysis.
4. For each of the 11 dominant generation mixes a histogram (according to installed capacity) has been derived as presented in Figures 15 and 16 for scenarios 1 and 2 respectively.
5. Furthermore, in order to compensate for the missing DG connection data (not all DG registers were available) the connection numbers included in the histograms (Figures 15 and 16) were scaled up proportionally to the number of primary substations. Referring to the substation numbers included in Table 16 the following constant multiplication factor was used:

$$f_{DG} = \frac{5563}{240+493+415+191+422+262+478+66+367+532+399} = 1.439.$$

6. The pre-processed histograms as described in points 1 through to 6 formed a basis for the calculation of the probability $P_{23(m,j)}$ according to equation (5) where the histogram data is assigned to $n_{DGG(m,j)}$.

Group	Substations	Percentage
SM	346	14.4
PV	1049	43.6
DFIG	178	7.4
IM	23	1.0
PMSG	3	0.1
SM, PV	424	17.6
SM, DFIG	47	2.0
SM, IM	3	0.1
SM, PMSG	0	0.0
PV, DFIG	215	8.9
PV, IM	20	0.8
PV, PMSG	1	0.0
DFIG, IM	9	0.4
DFIG, PMSG	9	0.4
IM, PMSG	0	0.0
SM, PV, DFIG	58	2.4
SM, PV, IM	8	0.3
SM, PV, PMSG	0	0.0
SM, DFIG, IM	1	0.0
SM, DFIG, PMSG	0	0.0
SM, IM, PMSG	0	0.0
PV, DFIG, IM	12	0.5
PV, DFIG, PMSG	1	0.0
PV, IM, PMSG	0	0.0
DFIG, IM, PMSG	0	0.0
SM, PV, DFIG, IM	1	0.0
SM, PV, DFIG, PMSG	0	0.0
SM, PV, IM, PMSG	0	0.0
SM, DFIG, IM, PMSG	0	0.0
PV, DFIG, IM, PMSG	0	0.0
Total	2408	100.0

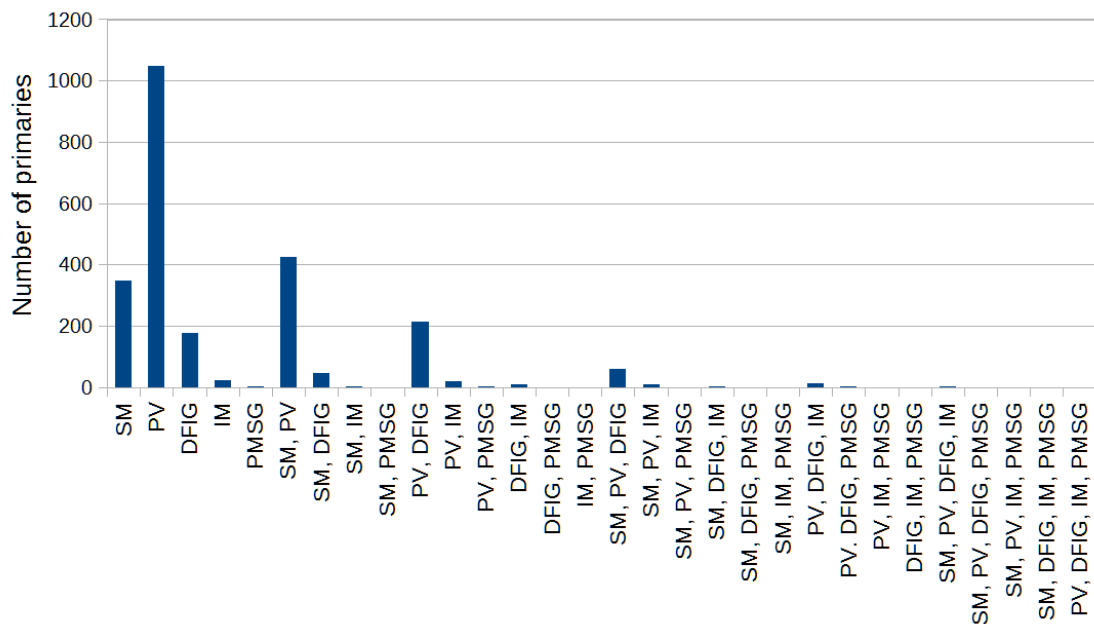

Figure 13. Islanding groups at the primary substation level (Scenario 1)

Group	HV feeders	Percentage
SM	844	6.1
PV	11789	84.7
DFIG	520	3.7
IM	36	0.3
PMSG	1	0.0
SM, PV	260	1.9
SM, DFIG	111	0.8
SM, IM	10	0.1
SM, PMSG	0	0.0
PV, DFIG	246	1.8
PV, IM	13	0.1
PV, PMSG	1	0.0
DFIG, IM	14	0.1
DFIG, PMSG	1	0.0
IM, PMSG	0	0.0
SM, PV, DFIG	47	0.3
SM, PV, IM	9	0.1
SM, PV, PMSG	0	0.0
SM, DFIG, IM	1	0.0
SM, DFIG, PMSG	0	0.0
SM, IM, PMSG	0	0.0
PV, DFIG, IM	13	0.1
PV, DFIG, PMSG	0	0.0
PV, IM, PMSG	0	0.0
DFIG, IM, PMSG	0	0.0
SM, PV, DFIG, IM	0	0.0
SM, PV, DFIG, PMSG	0	0.0
SM, PV, IM, PMSG	0	0.0
SM, DFIG, IM, PMSG	0	0.0
PV, DFIG, IM, PMSG	0	0.0
Total	13916	100.0

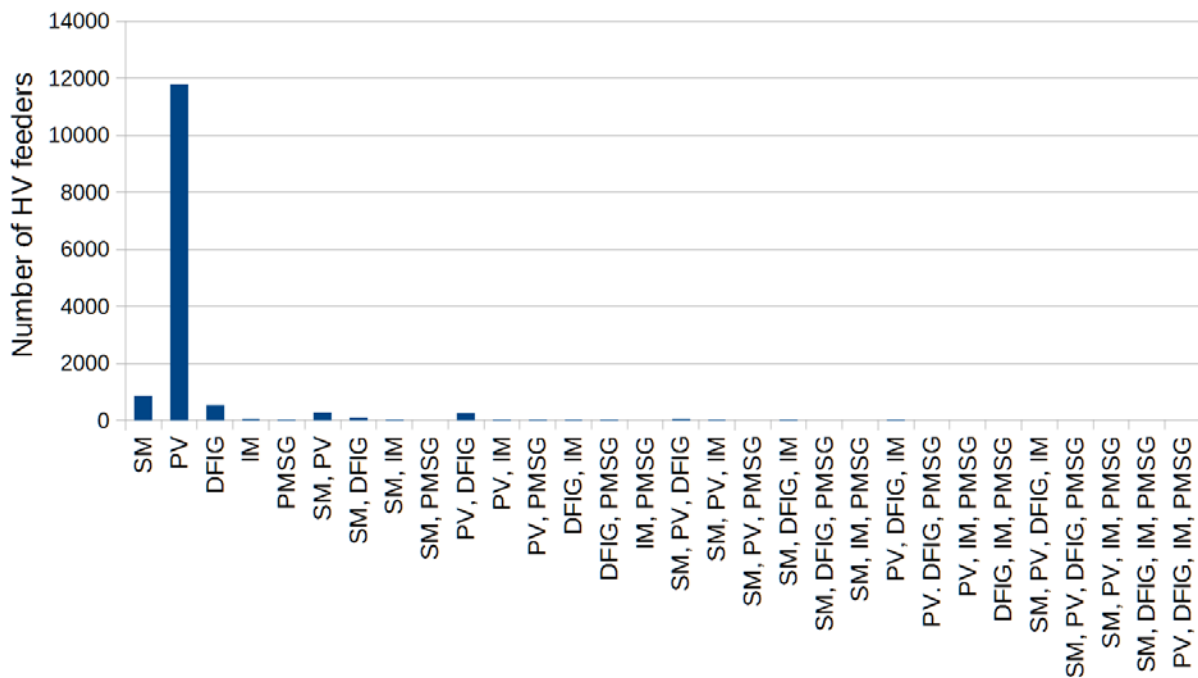

Figure 14. Islanding groups at the HV feeder level (Scenario 2)

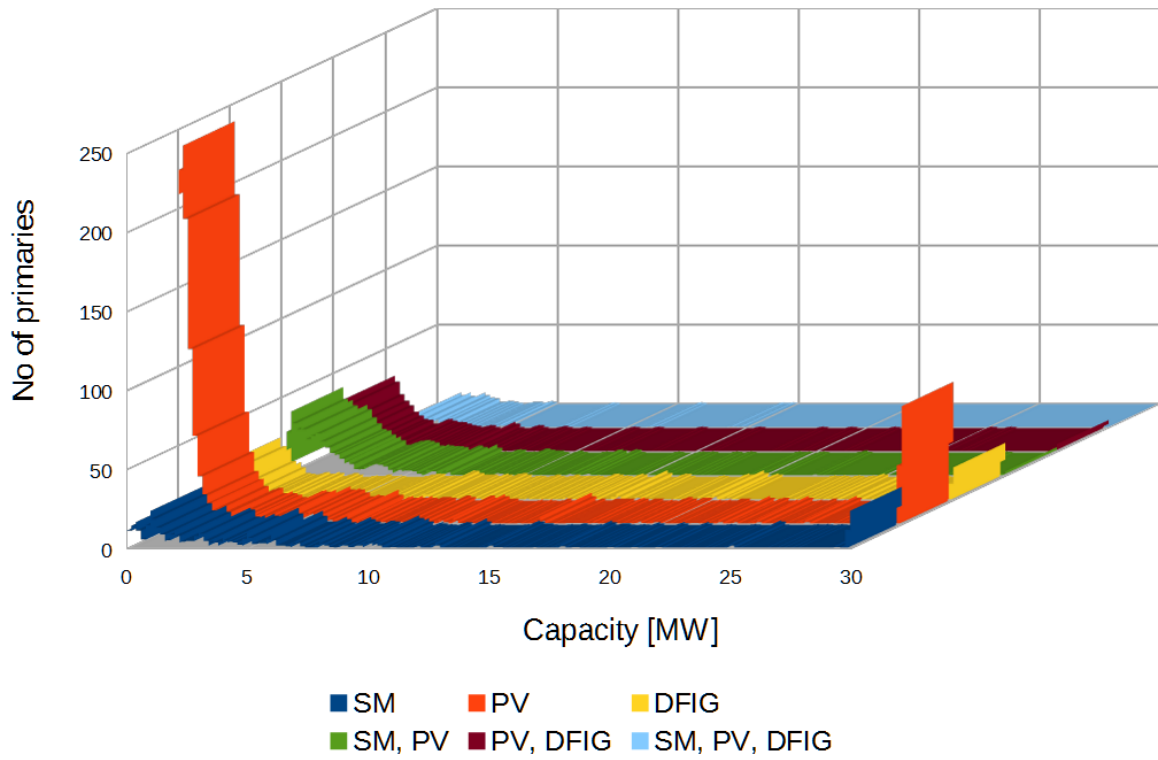

Figure 15. Histogram representing distribution of dominant generation mixes in Scenario 1

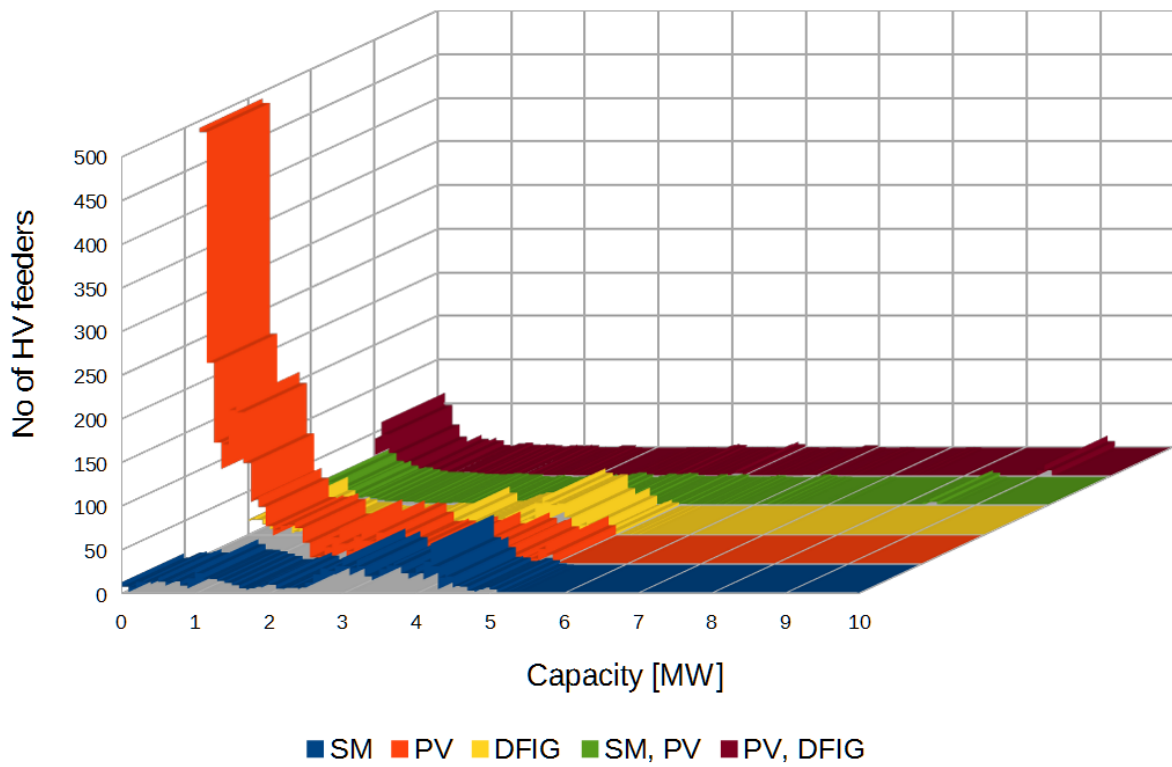

Figure 16. Histogram representing distribution of dominant generation mixes in Scenario 2

4.2.3 Usage of ROCOF LOM protection

According to the DG characterisation surveys performed by ECOFYS and reported in [10], it is not possible to establish (or even estimate) accurate numbers of generators (within each generating technology) that are protected against LOM using dedicated external ROCOF relays. The only point of reference is Figure 12 on page 26 of the report [10] (reproduced below as Figure 17) and discussions with the GC0079 working group members. Based on these sources it was first assumed that there is a negligible amount of specific ROCOF protection algorithms being used in LV connected generation. For the remaining HV connections it was assumed that specific ROCOF presence in HV connected generation is $P_{ROCOF} = 0.8, 0.1$ and 0.5 for Synchronous, Inverter and DFIG type generation respectively.

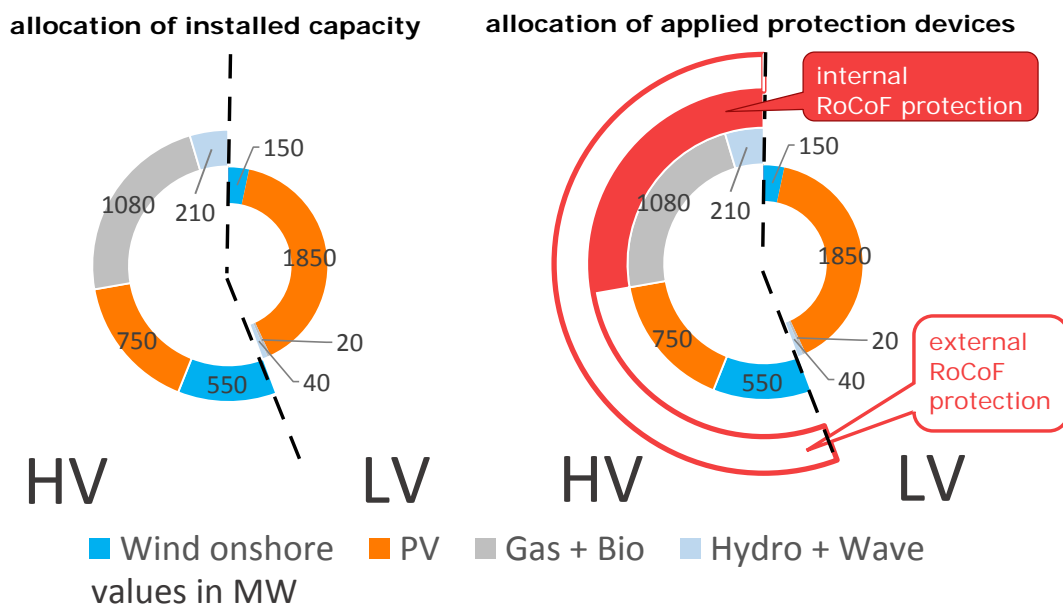

Figure 17. Indicative illustration of technology shares (<5 MWe) per voltage level (left) and potential application of ROCOF protection (right), HV: high voltage level, LV: low voltage level, internal ROCOF: protection is part of the genuine plant control, external ROCOF: protection by separate devices at the point of common coupling, year: end of 2013 [10]

When considering multi-generator islands, the level of ROCOF protection usage has been derived under the assumption that it is sufficient to effectively de-energise an island if at least one of the technologies is equipped with a ROCOF relay. In terms of probability this can be calculated as follows:

$$P_{ROCOF_OK} = 1 - P_{NO_ROCOF} = 1 - \sum_{i=1}^N (1 - P_{ROCOF(i)}) \quad (18)$$

Although it is understandable that the above assumption is not fully accurate as the extent of the NDZ may vary depending on the proportion of ROCOF usage within an island, it is also considered unlikely that after tripping of one of the generators (especially in a small group of two or three) the remaining units will continue generating for any extended periods of time without being disconnected by other G59 protection. From the analysis of the DG register it appears that, apart

from very large numbers and concentrations of PV, other technologies are much more dispersed and potential multi-generator islands are in the minority, especially when considering islanding scenario 2 (HV feeder) which dominates in this risk assessment. The assumed ROCOF usage figures for each of the generation mixes are included in Table 18.

Table 18. Assumed ROCOF usage in HV connected generation

Grouping	Generation Mix	Generator Technology			ROCOF Protection Usage (1.0 = 100%)	
		Synchronous Generator	PV	DFIG		
Single	1	2 MVA	-	-	0.8	Assumed
	2	-	2 MVA	-	0.1	
	3	-	-	2 MVA	0.5	
Groups of 2	4	1.5 MVA	0.5 MVA	-	0.82	Derived using equation (18)
	5	1 MVA	1 MVA	-	0.82	
	6	0.5 MVA	1.5 MVA	-	0.82	
	7	-	1.5 MVA	0.5 MVA	0.55	
	8	-	1 MVA	1 MVA	0.55	
	9	-	0.5 MVA	1.5 MVA	0.55	
Groups of 3	10	1.4 MVA	0.3 MVA	0.3 MVA	0.91	
	11	0.3 MVA	1.4 MVA	0.3 MVA	0.91	
	12	0.3 MVA	0.3 MVA	1.4 MVA	0.91	

4.2.4 Load profile data

In order to cover a wide range of possible loading scenarios and capacities, six different active and reactive (P and Q) load profiles have been included in this study. These profiles were recorded by the DNOs at various primary and secondary distribution substations. This section includes a brief description of each record including a graphical illustration of the P and Q traces. All records have been time aligned to start at 00:00:00hs in order to properly coincide with time-of-day-dependent variation of PV generation. Additionally, all records were resampled (if necessary) to 1s resolution and trimmed (or extended) to a fixed duration of one week.

4.2.4.1 Load Profile LP1 (WPD)

This record (provided by WPD) has been measured on one of the two parallel-connected 33/11kV 24MVA transformers supplying an 11kV busbar at a primary substation which feeds a mixture of domestic, commercial and industrial load. The time adjusted trace is presented in Figure 18. Two variants of the record were used in the risk assessment calculations: LP1a – original values as recorded from a single transformer (used in scenario 2), and LP1b where all the values were doubled to obtain the full load of the primary substation (used in scenario 1) assuming equal load sharing between both transformers at the primary substation.

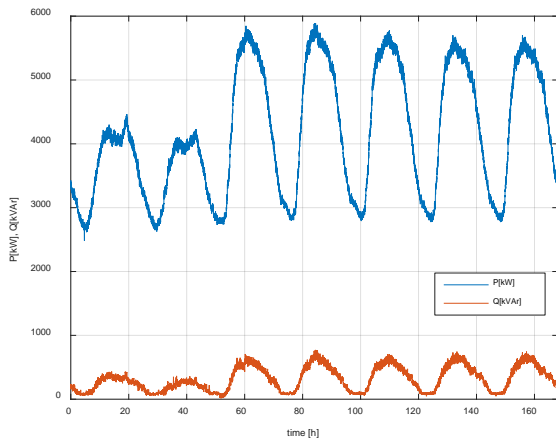

a) Load Profile LP1a

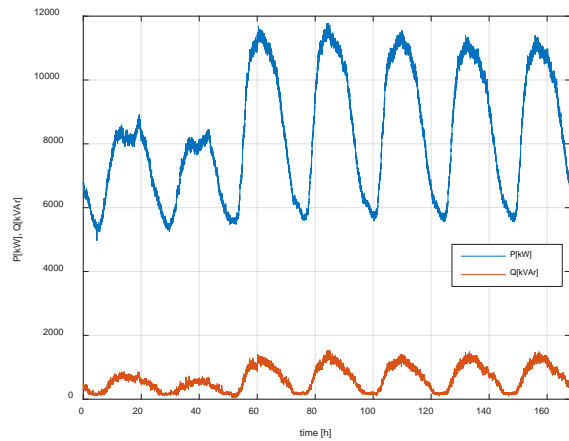

b) Load Profile PL1b

Figure 18. 11kV Load Monitoring Data – WPD – October 2014

4.2.4.2 Load Profile LP2 (ENW)

This load trace was recorded during Phase I of the work in a rural primary substation supplied by a single transformer, and is presented in Figure 19. The week-long record was synthesised using available 3 days' worth of monitoring data – one week day plus Saturday and Sunday. This record was used in risk assessment of islanding scenario 1.

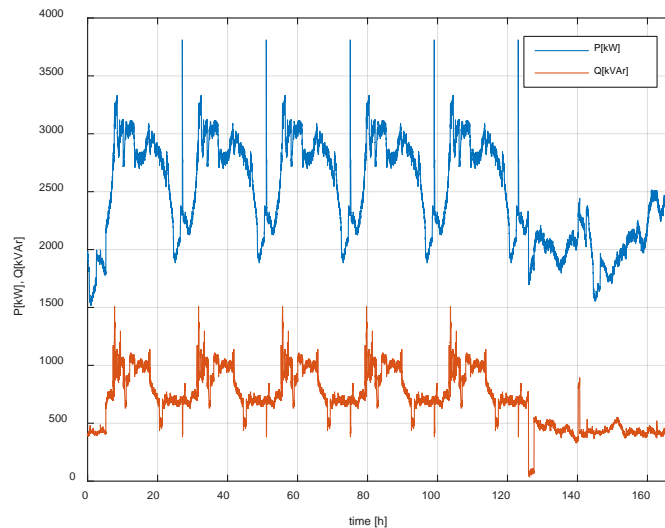

Figure 19. Load Monitoring Data captured in Phase I – April 2013

4.2.4.3 Load Profiles LP3 and LP4 (ENW)

These two load profiles (termed as LP3 and LP4) were recorded by ENW in 2008 and previously used in the risk assessment of NVD protection [7][8]. Both records were captured with 1s resolution and contain a good daily spread of demand as well as a number of short-term variations. As the data was recorded over a 24h period only, a week-long record was synthesised by repeating the daily profile 7 times as illustrated in Figure 20. The records were used in both islanding scenarios 1 and 2.

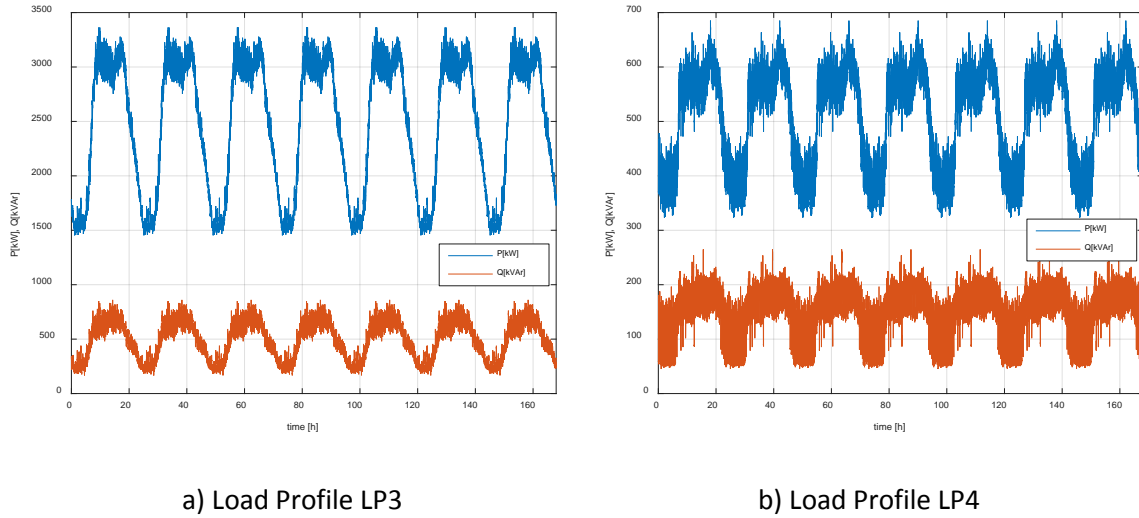

Figure 20. Two 1s records (over 24h) – 23 October 2008

4.2.4.4 Load Profile LP5 and LP6 (ENW)

These two records (termed as LP5 and LP6) were recorded by ENW at the supply point to an LV board, i.e. the secondary side of a distribution transformer. As the peak demand reaches 400kW only both records were used in scenario 2 while LP5 was also used in scenario 1 as an example of very low demand on a primary substation.

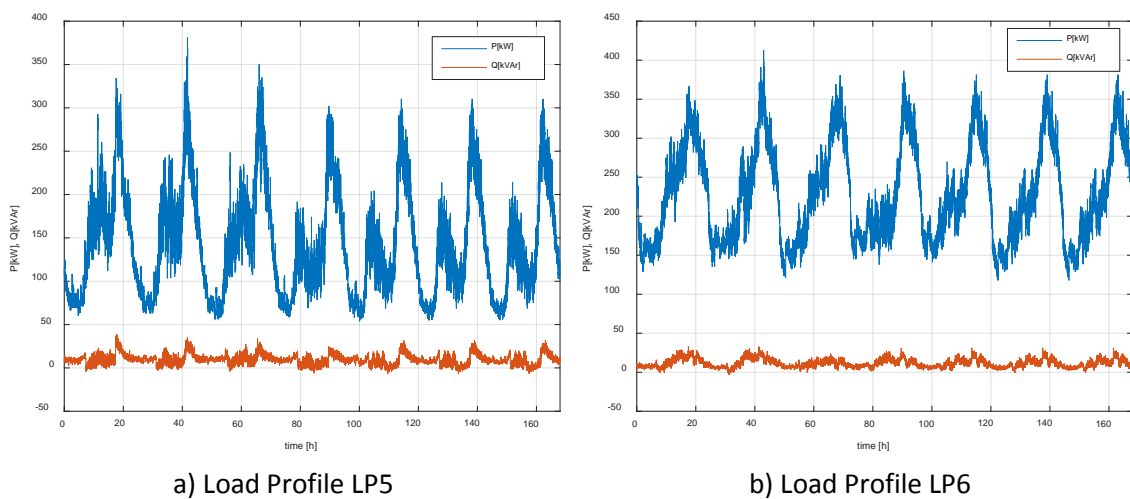

Figure 21. Two LV switchboard recorded profiles (ENW) – February 2015

4.2.5 DG generation profiles

In order to match detailed load profiles with realistic generation outputs, example profiles of different technologies were utilised in this work. Three distinct categories of generating outputs were considered, namely: synchronous, solar and wind generation.

- For synchronous generation a fixed output profile was synthesised at the assumed $pf=0.995$ (lagging). This is illustrated in Figure 22a.
- For solar generation two example days recorded by SSE in different seasons were utilised from which a week-long profile was synthesised as shown in Figure 22b.
- Similarly, for wind generation two example days were used to create a week-long profile as illustrated in Figure 22c.

Moreover, for other generating mixes involving more than one technology, a number of merged generation profiles were created as illustrated in Figures 23, 24 and 25. These profiles correspond to the generating mixes as defined earlier in Table 3. The profile merging was achieved by scaling the peak real power of individual records according to the relative contribution of each generation type in the mix. All profiles were then normalised to have a maximum real power at 5MW. This value, however, has no bearing on the results, as the profiles are rescaled again when the calculations step through the capacity bands of the generation distribution histograms (refer to Figures 15 and 16).

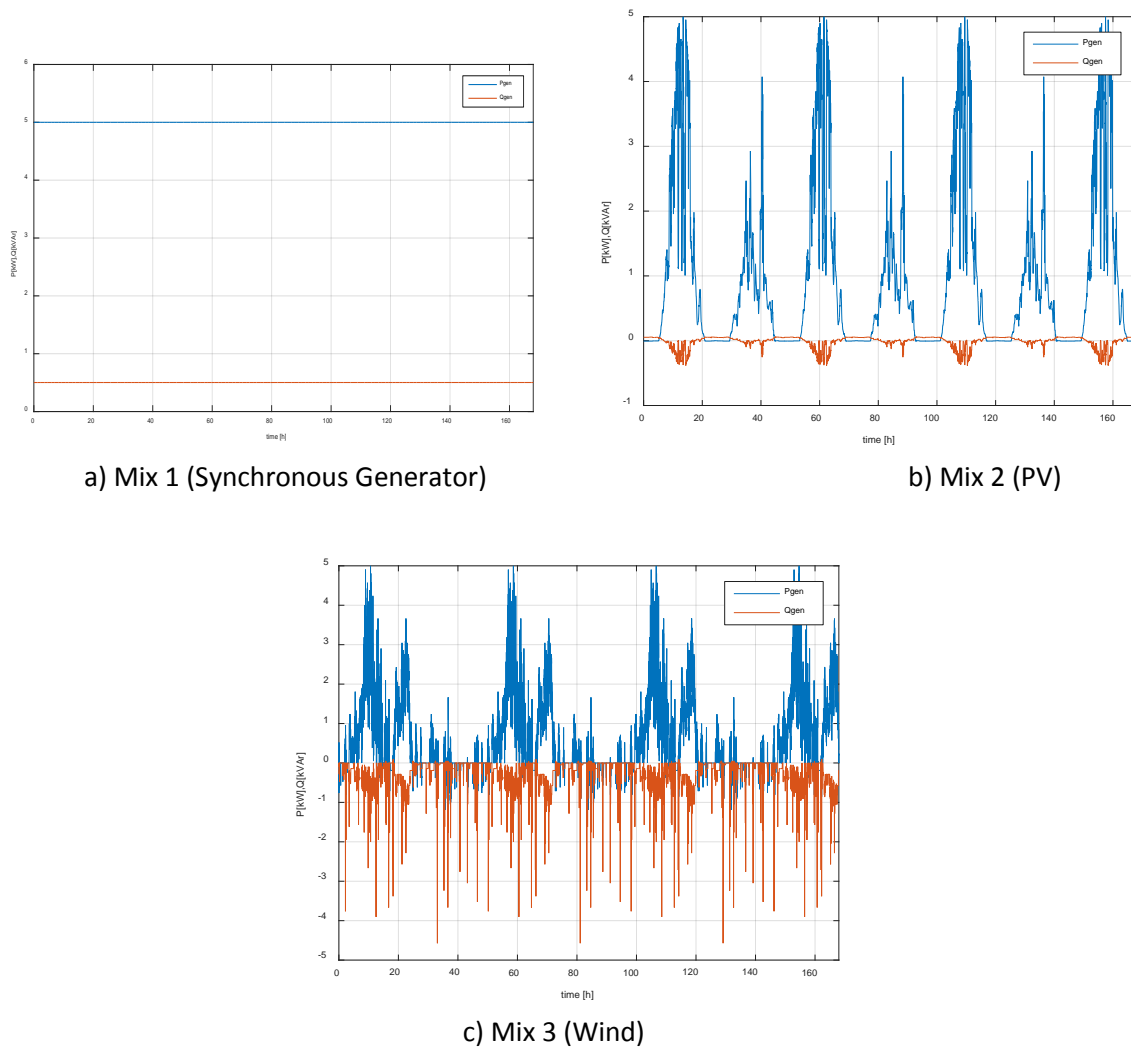
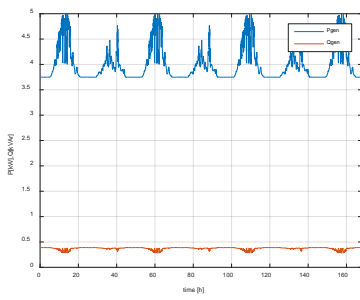
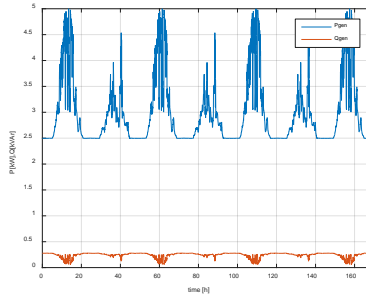

Figure 22. Example load profiles from individual DG technologies



a) Mix 4 (75% SG + 25% PV)



b) Mix 5 (50% SG + 50% PV)

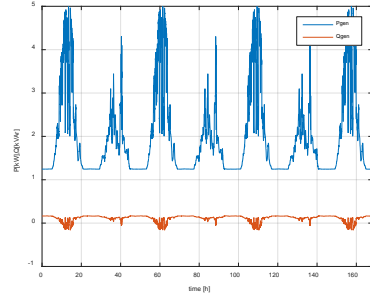

c) Mix 6 (25% SG + 75% PV)

Figure 23. Mixed generation profile – SG/PV

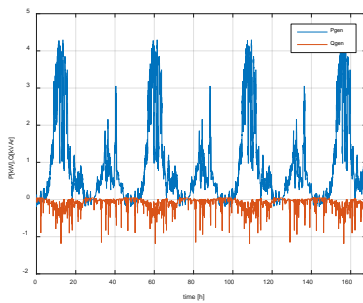

a) Mix 7 (75% PV + 25%Wind)

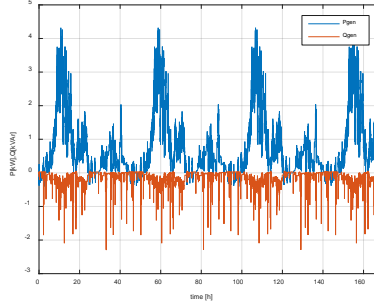

b) Mix 8 (50% PV + 50%Wind)

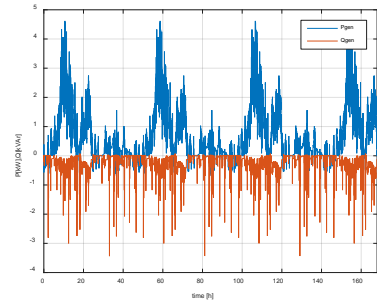

c) Mix 9 (25% PV + 75%Wind)

Figure 24. Mixed generation profile – PV/Wind

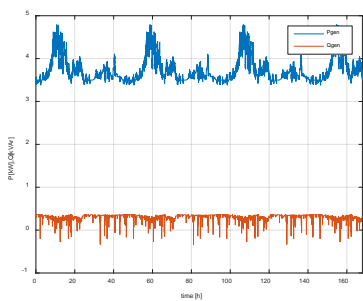

a) Mix 10 (70% SG+15% PV+15%Wind)

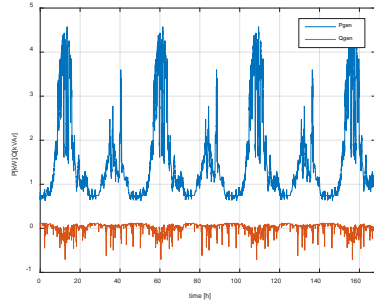

b) Mix 11 (15% SG+70% PV+15%Wind)

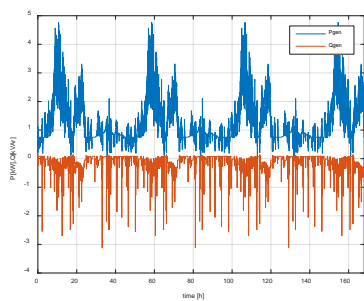

c) Mix 12 (15% SG+15% PV+70%Wind)

Figure 25. Mixed generation profile – SG/PV/Wind

4.2.6 Generation load factor

The load factor can be defined as the average load divided by the peak load in a specified time period. With generation such as PV and Wind the load factor as a consequence of the specific energy source and cannot be controlled. In this study, therefore, for PV and DFIG generation the load factor is included in the form of the applied generation profile characteristic of given generation. However, for generation where constant (near nominal) load is a predominant way of operation (or else the generator is disconnected) which is typical for synchronous based generation with controllable energy source, it was assumed that Load Factor is 2/3, i.e. the unit is generating 16h per day on average.

When considering multi-generator islands, the LF has been derived under the assumption that it is proportional to the share of the generator capacity in a given mix of generators. The assumed and derived load factor values are summarised in Table 19.

Table 19. Assumed Load factors for different generation mixes

Grouping	Generation Mix	Generator Technology			Load Factor (1.0 = 100%)	
		Synchronous Generator	PV	DFIG		
Single	1	2 MVA	-	-	0.667	Assumed
	2	-	2 MVA	-	1.000	
	3	-	-	2 MVA	1.000	
Groups of 2	4	1.5 MVA	0.5 MVA	-	0.750	Derived
	5	1 MVA	1 MVA	-	0.833	
	6	0.5 MVA	1.5 MVA	-	0.917	
	7	-	1.5 MVA	0.5 MVA	1.000	
	8	-	1 MVA	1 MVA	1.000	
	9	-	0.5 MVA	1.5 MVA	1.000	
Groups of 3	10	1.4 MVA	0.3 MVA	0.3 MVA	0.767	
	11	0.3 MVA	1.4 MVA	0.3 MVA	0.950	
	12	0.3 MVA	0.3 MVA	1.4 MVA	0.950	

4.3 Risk calculation results

The full numerical record of probability calculations performed for the two assumed islanding scenarios (with 12 different generation mixes in scenario 1, and 9 mixes in scenarios 2), considering six load profiles in each scenario and each of the four LOM protection setting options, is included in Appendix C. The results take into account the fact that G59 protection is always enabled and trips the generator in situations where ROCOF relay sensitivity is poor. Additionally, for ease of analysis, all results are also presented graphically in Figures 50 to 59. It should be noted that in a number of cases the final probability was equal to zero. In order to represent this result on the graph using a logarithmic scale, a small value of 10^{-11} was used rather than zero. All other non-zero results were always higher than 10^{-11} , so this value can be used as an unambiguous indicator of a zero result.

4.3.1 Calculation of overall figures

Considering all load cases, generation mixes and islanding scenarios, the overall probability figures N_{LOM} and P_{LOM} have been obtained (based on results in Appendix C). Moreover, both probability of Individual Risk (IR_E) and expected annual rate of occurrence of out-of-phase auto-reclosure (N_{OA}) were calculated using the formulae (16) and (17). The figures were obtained in two different ways, first by using the worst load profile result (as presented in Table 20), and then by averaging the probability figures across all the profiles (as presented in Table 21).

Table 20. Worst load profile based figures for P_{LOM} , IR_E and N_{OA}

Setting Option	ROCOF [Hz/s]	Time Delay [s]	N_{LOM}	P_{LOM}	IR_E	N_{OA}
1	0.13	0	7.42E-01	3.91E-07	3.91E-09	5.94E-01
2	0.2	0	1.52E+00	9.54E-07	9.54E-09	1.22E+00
3	0.5	0.5	5.47E+01	3.45E-05	3.45E-07	4.38E+01
4	1.0	0.5	1.07E+02	6.78E-05	6.78E-07	8.57E+01

Table 21. Figures for P_{LOM} , IR_E and N_{OA} obtained through averaging of all load profiles

Setting Option	ROCOF [Hz/s]	Time Delay [s]	N_{LOM}	P_{LOM}	IR_E	N_{OA}
1	0.13	0	1.66E-01	8.06E-08	8.06E-10	1.33E-01
2	0.2	0	3.29E-01	1.95E-07	1.95E-09	2.64E-01
3	0.5	0.5	2.96E+01	1.87E-05	1.87E-07	2.37E+01
4	1.0	0.5	5.66E+01	3.57E-05	3.57E-07	4.53E+01

The above figures represent the probabilities of the perceived hazards (*IR* and *OA*) under four different ROCOF protection setting options when applied to the existing generators in UK with ratings below 5MW. It is important to bear in mind the following points when using these results to inform decision-making processes:

- The presented probability figures are based on connections registers which may already be out of date due to the rapidly growing number of DG installations (and changes in DG types) in the UK.
- The probabilities will increase (or decrease) in proportion to the total number of separate islanding points as well as being dependent on the usage of dedicated ROCOF-based protection. However, due to generation grouping, the number of islanding points is growing more slowly than the absolute number of individual DG connections.
- The study does not include the assessment of the impact of any changes in practice for other forms of LOM protection (e.g. voltage vector shift).
- Wherever exact data was not available, pessimistic assumptions were always made so that the final probability values will ideally never be lower than reality, but this also means that the final figures are potentially higher than reality.
- The results obtained from the worst case scenario (Table 20) is more than two times higher compared to the result based on averaged figures (Table 21). It is considered more appropriate to select the averaged figures as being more accurate.
- The results are expressed as probabilities of specific events or occurrences happening over a period of one year. By inverting these values, the average expected times between such occurrences can be calculated.
- The calculation does not include the effects of possible other LOM methods applied in practice, in particular Vector Shift (VS). In case of mixed islands the potential presence of other LOM methods is considered neutral to the presented figures, i.e. their effectiveness (sensitivity to LOM events) is no better than ROCOF.

5 Conclusions

When analysing the results the following observations can be made:

- ROCOF protection becomes very ineffective, especially with proposed setting option 4 (1 Hz/s with 500 ms delay). When using this setting, the generator is disconnected by G59 protection (as opposed to ROCOF) in the majority of islanding situations when considering 3s as a maximum LOM detection time. This is due to the observed frequency fluctuations with certain generation mixes. It is likely that this effect is caused by inverter controller interactions on PV and DFIG generators. One of the ways this effect can be mitigated is the reduction of the ROCOF relay time delay setting. However, further work would be required to arrive at the best compromise time delay figure.
- Comparing the results for islanding scenarios 1 (loss of primary substation) and 2 (loss of an 11kV feeder), it is apparent that the final probability figures are dominated by scenario 2, the risk figures being two orders of magnitude higher than those for scenario 1 (refer to Tables 41 and 42 in Appendix C.1.). This is primarily caused by a much higher number of islanding points (HV feeders in scenario 2 compared to primary substations in scenario 1) as well as much higher network incident rates which could potentially lead to islanding operation (HV circuit faults in scenario 2 compared to loss of supply to a primary substation in scenario 1).
- There is a significant difference (approximately two orders of magnitude) in the probability of undetected islanded operation between the existing recommended ROCOF settings (setting options 1 and 2) and the considered new setting options 3 and 4. Therefore, the impact of the proposed change can be considered as high, even if the absolute numbers are not accurate due to pessimistic assumptions. In particular, the assumption of the presence of voltage controllers on all generators, as well as the absence of network faults during islanding incidents, would have contributed to wider NDZ values, and consequently a higher probability of undetected islanding. It is worth noting that in Phase I of the work where both P-V and P-pf controllers were considered, the increase of probability figures for the same setting (1 Hz/s - 0.5 s delay) was also approximately 2 orders of magnitude.
- The risk associated with the considered future setting options 4 is approximately 50% higher than the risk of adopting the setting option 3. This is much smaller than the difference between the existing practice and the two considered future options 3 and 4.
- Risk related to accidental electrocution (IR_E) for proposed setting option 4 (in the region of 10^{-7}) lies in the broadly acceptable region according to the Health and Safety at Work Act 1974. Therefore, it can be viewed as acceptable according to the Act.
- The rate of occurrence of out-of-phase auto-reclosing (N_{OA}) appears to be high with the proposed setting option 4 (nearly 50 expected incidents p.a.), and therefore, cannot be neglected. Further assessment of the anticipated costs and consequences of out-of-phase auto-reclosing to individual generating technologies is required to realistically assess the proportion of those incidents which would cause serious damage to the generator or endanger personnel. The presented final figures make no such distinction and assume that 80% of all out-of-phase re-closures are damaging. Moreover, consideration of the proportion of the network where auto-reclose is not enabled (e.g. underground cables) would reduce the expected number of out-of-phase reclosures further.

- The overall high levels of risk, especially in terms of out-of-phase reclosure can be attributed to the following factors:
 - a) The assumed existence of the P-V controller which has been used in DFIG modelling. Although fast acting voltage controllers are typically not present in the majority of existing DFIG connections, the situation is likely to change when increased numbers of generators will be expected to provide network voltage support. Therefore, this assumption may no longer be pessimistic in the future. In Phase I of the work the influence of the controller type has been investigated and found to affect the risk figures by two orders of magnitude, i.e. when P-V controller was used compared to the P-pf control.
 - b) The assumed absence of network disturbance associated with the LOM event. In the vast majority of cases, especially in scenario 2 (HV feeder loss), there is a fault (mostly single phase-to-earth) which leads to the loss of supply, as well as loss of earthing. Even though the generator will not see the fault after it has been cleared by the network protection (when connected by star-delta step-up transformer), in the initial period after the fault inception, there will be a short voltage dip which may destabilise the generator, and thus reducing the NDZ.
 - c) The oscillatory nature of frequency response during islanding of some of the existing generation mixes as demonstrated in Figures 7 and 8. As discussed at the end of section 3.4 frequency oscillations cause the relay to reset periodically when certain time delay is applied which significantly widens NDZ and in some cases makes the ROCOF relay inoperative.
 - d) The oscillatory nature of frequency response during islanding of some of the existing generation mixes.
 - e) High number of DG connections and islanding points.

- To inform the decision making process further the individual percentage contributions to the overall number of out-of-phase incidents (N_{LOM}) have been established and presented in Figure 22 (based on the detailed results included in Appendix C.2.). As observed earlier, there is a clear indication that the final result is primarily determined by islanding scenario 2. Moreover, looking at various generation mixes, islanding of individual technologies (SG and DFIG - $m=1$ and 3) has the highest contribution to overall risk figures (approximately 60% of the overall risk). This is caused primarily by the relatively higher numbers of single technology islands, compared to the groups of generators which is particularly true in islanding scenario 2 (refer to the table included in Figure 14). However, with continuing increase of the DG penetration levels the proportion of individual HV feeders with more than one generating technology is likely to increase. Relatively lower contribution of PV (despite high connection numbers) is due to low assumed usage of ROCOF relay (10% of connections) as well as generally narrow NDZ (based on voltage and frequency G59 protection response).

Table 22. Contribution of individual generation mixes to the overall number of LOM incidents (individual figures averaged across all load profiles)

Islanding Scenario	Generation Mix (m)	$N_{LOM(m)}$	$N_{LOM(m)}[\%]$
1	1 (100% SG)	0.0465	0.0822
	2 (100% PV)	0.0031	0.0055
	3 (100% DFIG)	0.2212	0.3907
	4 (75% SG + 25% PV)	0.0155	0.0274
	5 (50% SG + 50% PV)	0.0148	0.0261
	6 (25% SG + 75% PV)	0.0225	0.0398
	7 (75% PV + 25% DFIG)	0.0186	0.0328
	8 (50% PV + 50% DFIG)	0.1133	0.2001
	9 (25% PV + 75% DFIG)	0.0733	0.1295
	10 (70% SG + 15% PV + 15% DFIG)	0.0035	0.0062
	11 (15% SG + 70% PV + 15% DFIG)	0.0059	0.0105
	12 (15% SG + 15% PV + 70% DFIG)	0.0205	0.0362
2	1 (100% SG)	18.3032	32.3278
	2 (100% PV)	0.9434	1.6662
	3 (100% DFIG)	16.5505	29.2320
	4 (75% SG + 25% PV)	1.8706	3.3039
	5 (50% SG + 50% PV)	1.7083	3.0172
	6 (25% SG + 75% PV)	1.6359	2.8894
	7 (75% PV + 25% DFIG)	1.3865	2.4488
	8 (50% PV + 50% DFIG)	8.0429	14.2056
	9 (25% PV + 75% DFIG)	5.6177	9.9221
Total:		56.6176	100.000

6 References

- [1] A. Dyśko, I. Abdulhadi, X. Li, C. Booth, "Assessment of Risks Resulting from the Adjustment of ROCOF Based Loss of Mains Protection Settings - Phase I", University of Strathclyde, ref: NGC/LOM/TR/2013-001b, June 2013.
- [2] "Health and Safety at Work etc. Act 1974", Health and Safety Executive, available at: <http://www.legislation.gov.uk/ukpga/1974/37/contents>
- [3] A. Dyśko, "Assessment of the Risks Associated with Adjustment of ROCOF based Loss-Of-Mains Protection Settings - Proposal", University of Strathclyde, ref: NGC/LOM/RP/2014-003B, September 2014.
- [4] R. Bugdał, A. Dyśko, G.M. Burt, J.R. McDonald, "Performance Analysis of the ROCOF and Vector Shift Methods Using a Dynamic Protection Modelling Approach", presented at the 15th International Conference on Power System Protection, pp. 139-144, Bled, Slovenia, 6-8 September 2006.
- [5] Power System Dynamic Performance Committee, "Dynamic Models for Turbine-Governors in Power System Studies", IEEE Power & Energy Society, Jan 2013.
- [6] T. Esum and P. L. Chapman, "Comparison of photovoltaic array maximum power point tracking techniques," IEEE Trans. Energy Convers., Vol. 22, No. 2, pp. 439–449, Jun. 2007.
- [7] A. Dyśko, A. MacKay, G. Burt, "Neutral Voltage Displacement Protection Requirement for DG", DTI Centre for Sustainable Electricity and Distributed Generation, 2009.
- [8] Distribution Code Review Panel G59 NVD Working Group, "Embedded generation interface protection: Assessment of risks arising from relaxation in the application of neutral voltage displacement (NVD) interface protection." Energy Networks Association, 31-Dec-2009.
- [9] Electricity Networks Association, "ER G59/3: Recommendations for the Connection of Generating Plant to the Distribution Systems of Licensed Distribution Network Operators," Issue 3, Aug. 2014.
- [10] M. Doering, K. Burges, F. Comaty, "Distributed Generation Operation in an Islanded Network – Final Report", ECOFYS, 11 August 2015.
- [11] Western Power Distribution, "Generation capacity register", available at: <http://www.westernpower.co.uk/Connections/Generation/Generation-Capacity-Map/Generation-capacity-register.aspx>
- [12] Wikipedia, "Marginal Distribution", available at: https://en.wikipedia.org/wiki/Marginal_distribution#cite_ref-1

Appendix A: Simulation model parameters

Table 23. Line parameters used in the 11kV network

11kV Distribution Lines		
Line Section	Resistance (Ω)	Inductance (mH)
A-B	0.169	0.17
B-C	0.169	0.17
D-E	0.67	0.56
D-F	0.613	0.45

Table 24. Synchronous machine parameters

Power Rating [MVA]		2
Nominal Voltage [V]		440
Nominal Frequency [Hz]		50
Pole Pairs		2
Inertia Constant [s]		1.3
Reactances [p.u.]		
X_d		2.24
X_d'		0.17
X_d''		0.12
X_q		1.02
X_q''		0.13
X_l		0.18
Excitation System / Governor		
T_r		0.02
K_a		465
T_a		0.002
K_e		1
T_e		0.27
T_b		0
T_c		0
K_f		0.003
T_f		0.2
E_{fmin}		-8
E_{fmax}		8
K_p		0

Table 25. PV parameters

Panel			
Module		SunPower SPR-415E-WHT-D	
Parallel Strings		88	
Series Connected modules		7	
O.S Voltage [V]		85.3	
S.C Current [A]		6.09	
Inverter			
Input DC Voltage [V]		480	
Output AC Voltage [V]		250	
Nominal Frequency [Hz]		50	
R Choke [p.u.]		0.0017	
L Choke [p.u.]		0.17	
Inverter Current Regulator		Inverter Vdc Regulator	
Kp	0.32	Kp	2
Ki	20	Ki	385

Table 26. DGIG parameters

Power Rating [MVA]		2	
Nominal Voltage [V]		690	
Nominal Frequency [Hz]		50	
Pole Pairs		2	
Inertia Constant [s]		4	
Windings			
Stator Resistance [p.u.]		0.00488	
Stator Inductance [p.u.]		0.09241	
Rotor Resistance [p.u.]		0.00549	
Rotor Inductance [p.u.]		0.0997	
Mutual Inductance [p.u.]		4	
Rotor Side Converter			
Torque Controller Kp		20	
Torque Controller Ki		19	
Current Regulator Kp		0.08	
Current Regulator Ki		8	
Reactive Power Controller Kp		5	
Reactive Power Controller Ki		100	
Grid Side Converter			
V_{DC} Regulator Kp		3	
V_{DC} Regulator Ki		60	
Current Regulator Kp		10	
Current Regulator Ki		15	

Appendix B: Detailed record of NDZ Assessment

B.1. Tabular Results

Table 27. NDZ results for generation mix 1 (100% SG)

	NDZ_{PI} Import [%]	NDZ_{PE} Export [%]	NDZ_{QI} Import [%]	NDZ_{QE} Export [%]
ROCOF				
Setting Option 1	1.03	0.53	2.12	1.42
Setting Option 2	1.03	0.78	2.45	1.92
Setting Option 3	3.05	1.58	7.36	14.56
Setting Option 4	5.85	3.56	14.09	35.20
OF, UF, OV, UV				
UF/OF	6.92	3.14	12.16	23.67
UV/OV	>50%	>50%	>50%	>50%

Table 28. NDZ results for generation mix 2 (100% PV)

	NDZ_{PI} Import [%]	NDZ_{PE} Export [%]	NDZ_{QI} Import [%]	NDZ_{QE} Export [%]
ROCOF				
Setting Option 1	0	0	0	0
Setting Option 2	0	0	0	0
Setting Option 3	>50%	>50%	>50%	>50%
Setting Option 4	>50%	>50%	>50%	>50%
OF, UF, OV, UV				
UF/OF	0.65	0.87	0.28	0.43
UV/OV	16.49	17.13	8.32	4.35

Table 29. NDZ results for generation mix 3 (100% DFIG)

	NDZ_{PI} Import [%]	NDZ_{PE} Export [%]	NDZ_{QI} Import [%]	NDZ_{QE} Export [%]
ROCOF				
Setting Option 1	0	0	0	0
Setting Option 2	0	0	0	0
Setting Option 3	0.83	1.44	4.68	2.29
Setting Option 4	1.98	2.38	7.20	5.04
OF, UF, OV, UV				
UF/OF	3.97	2.69	8.69	9.98
UV/OV	8.18	12.02	>50%	17.92

Table 30. NDZ results for generation mix 4 (75% SG + 25% PV)

	NDZ_{PI} Import [%]	NDZ_{PE} Export [%]	NDZ_{QI} Import [%]	NDZ_{QE} Export [%]
ROCOF				
Setting Option 1	0.92	0.32	1.27	1.73
Setting Option 2	0.92	0.32	1.99	1.9
Setting Option 3	4.86	3.19	12.17	24.38
Setting Option 4	6.78	5.32	15.96	>50%
OF, UF, OV, UV				
UF/OF	5.37	2.49	8.65	17.45
UV/OV	>50%	>50%	>50%	>50%

Table 31. NDZ results for generation mix 5 (50% SG + 50% PV)

	NDZ_{PI} Import [%]	NDZ_{PE} Export [%]	NDZ_{QI} Import [%]	NDZ_{QE} Export [%]
ROCOF				
Setting Option 1	0	0	0	0
Setting Option 2	0	0	0	0
Setting Option 3	4.55	4.30	12.75	45.61
Setting Option 4	6.34	4.79	16.03	>50%
OF, UF, OV, UV				
UF/OF	3.85	1.66	5.26	11.23
UV/OV	>50%	>50%	>50%	>50%

Table 32. NDZ results for generation mix 6 (25% SG + 75% PV)

	NDZ_{PI} Import [%]	NDZ_{PE} Export [%]	NDZ_{QI} Import [%]	NDZ_{QE} Export [%]
ROCOF				
Setting Option 1	0	0	0	0
Setting Option 2	0	0	0	0
Setting Option 3	4.77	18.79	15.13	17.37
Setting Option 4	5.58	18.76	15.13	21.57
OF, UF, OV, UV				
UF/OF	2.43	1.10	2.31	6.33
UV/OV	>50%	>50%	>50%	>50%

Table 33. NDZ results for generation mix 7 (75% PV + 25% DFIG)

	NDZ_{PI} Import [%]	NDZ_{PE} Export [%]	NDZ_{QI} Import [%]	NDZ_{QE} Export [%]
ROCOF				
Setting Option 1	0	0	0	0
Setting Option 2	0	0	0	0
Setting Option 3	>50%	>50%	>50%	46.54
Setting Option 4	>50%	>50%	>50%	46.54
OF, UF, OV, UV				
UF/OF	2.21	0.47	1.06	2.59
UV/OV	40.22	14.13	>50%	4.38

Table 34. NDZ results for generation mix 8 (50% PV + 50% DFIG)

	NDZ_{PI} Import [%]	NDZ_{PE} Export [%]	NDZ_{QI} Import [%]	NDZ_{QE} Export [%]
ROCOF				
Setting Option 1	0	0	0	0
Setting Option 2	0	0	0	0
Setting Option 3	>50%	>50%	>50%	>50%
Setting Option 4	>50%	>50%	>50%	>50%
OF, UF, OV, UV				
UF/OF	>50%	1.08	2.69	4.83
UV/OV	20.08	21.23	>50%	>50%

Table 35. NDZ results for generation mix 9 (25% PV + 75% DFIG)

	NDZ_{PI} Import [%]	NDZ_{PE} Export [%]	NDZ_{QI} Import [%]	NDZ_{QE} Export [%]
ROCOF				
Setting Option 1	0	0	0	0
Setting Option 2	0	0	0	0
Setting Option 3	>50%	>50%	>50%	>50%
Setting Option 4	>50%	>50%	>50%	>50%
OF, UF, OV, UV				
UF/OF	>50%	1.77	5.41	7.02
UV/OV	6.11	18.71	39.21	12.33

Table 36. NDZ results for generation mix 10 (70% PV + 15% PV + 15% DFIG)

	NDZ_{PI} Import [%]	NDZ_{PE} Export [%]	NDZ_{QI} Import [%]	NDZ_{QE} Export [%]
ROCOF				
Setting Option 1	0.34	0.41	1.57	1.39
Setting Option 2	0.60	0.41	2.01	2.16
Setting Option 3	>50%	2.18	9.69	>50%
Setting Option 4	>50%	>50%	14.87	>50%
OF, UF, OV, UV				
UF/OF	5.23	2.45	10.14	19.24
UV/OV	>50%	>50%	>50%	>50%

Table 37. NDZ results for generation mix 11 (15% PV + 70% PV + 15% DFIG)

	NDZ_{PI} Import [%]	NDZ_{PE} Export [%]	NDZ_{QI} Import [%]	NDZ_{QE} Export [%]
ROCOF				
Setting Option 1	0	0	0	0
Setting Option 2	0	0	0	0
Setting Option 3	>50%	>50%	>50%	>50%
Setting Option 4	>50%	>50%	>50%	>50%
OF, UF, OV, UV				
UF/OF	2.60	0.93	2.77	6.44
UV/OV	>50%	>50%	>50%	>50%

Table 38. NDZ results for generation mix 12 (15% PV + 15% PV + 70% DFIG)

	NDZ_{PI} Import [%]	NDZ_{PE} Export [%]	NDZ_{QI} Import [%]	NDZ_{QE} Export [%]
ROCOF				
Setting Option 1	0	0	0	0
Setting Option 2	0	0	0	0
Setting Option 3	>50%	>50%	7.52	>50%
Setting Option 4	>50%	>50%	10.63	>50%
OF, UF, OV, UV				
UF/OF	3.80	2.29	8.93	12.78
UV/OV	>50%	33.75	>50%	12.78

B.2. NDZ Graphs

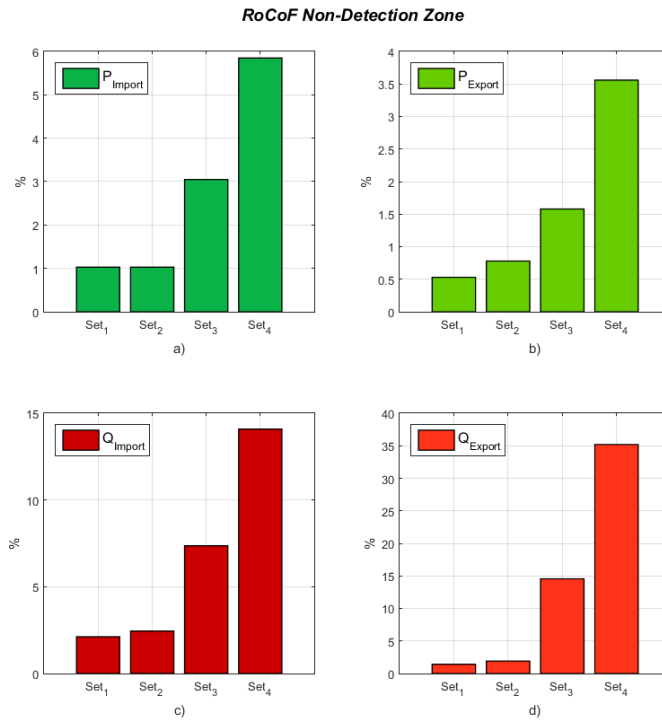

Figure 26. ROCOF NDZs for Generation Mix 1, a) Active power import, b) Active power export, c) Reactive power import, d) reactive power export

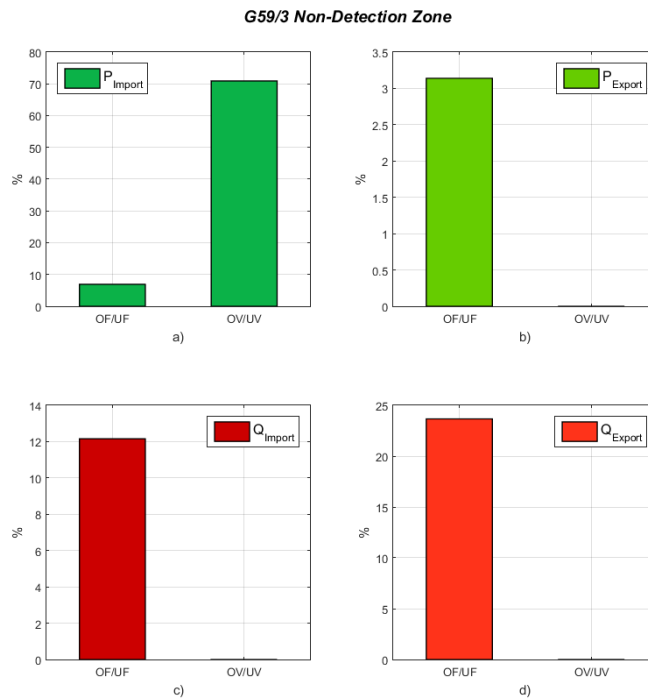

Figure 27. OF, UF,OV,UV Generation Mix 1, a) Active power import, b) Active power export, c) Reactive power import, d) reactive power export

RoCoF Non-Detection Zone

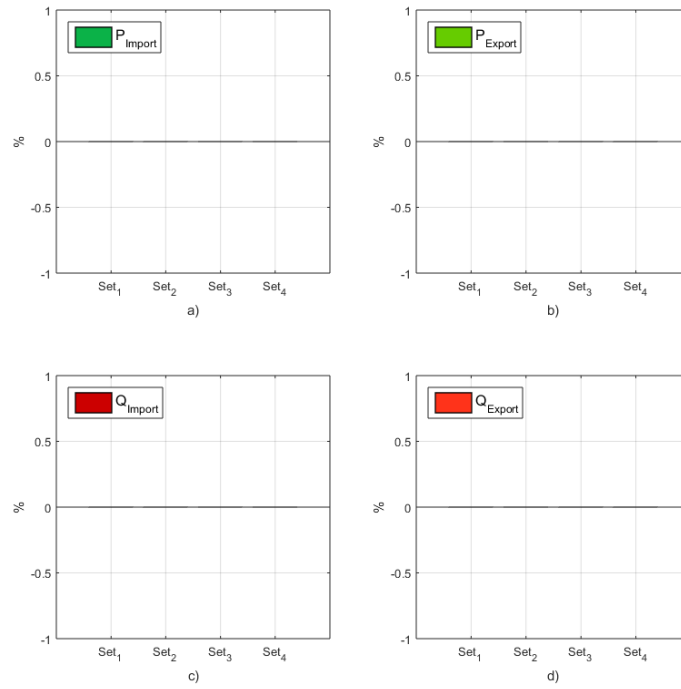

Figure 28. ROCOF NDZs for Generation Mix 2, a) Active power import, b) Active power export, c) Reactive power import, d) reactive power export

G59/3 Non-Detection Zone

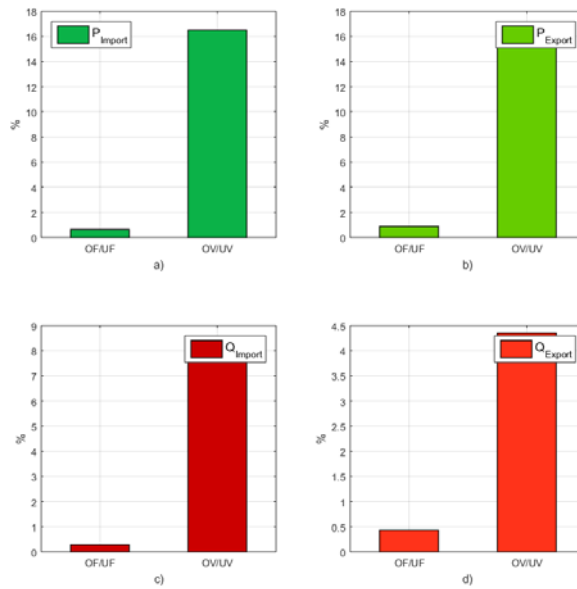

Figure 29. OF,UF,OV,UV NDZs for Generation Mix 2, a) Active power import, b) Active power export, c) Reactive power import, d) reactive power export

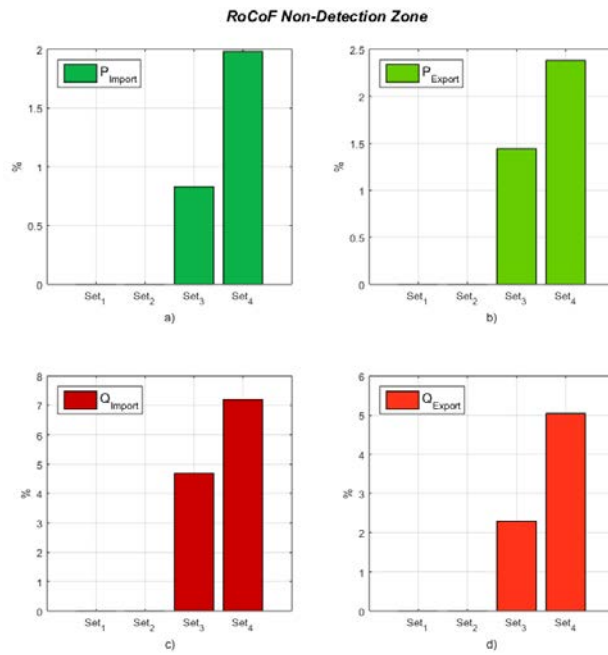

Figure 30. ROCOF NDZs for Generation Mix 3, a) Active power import, b) Active power export, c) Reactive power import, d) reactive power export

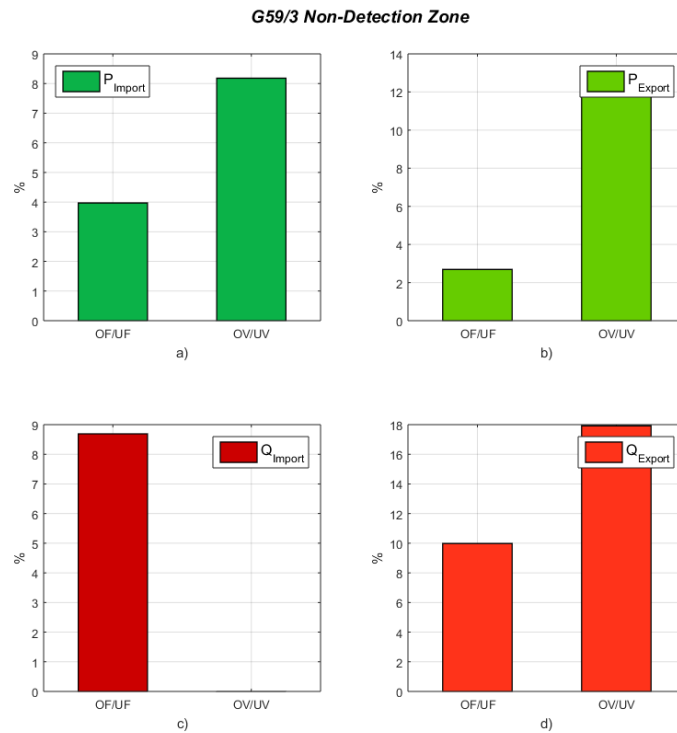

Figure 31. OF,UF,OV,UV NDZs for Generation Mix 3, a) Active power import, b) Active power export, c) Reactive power import, d) reactive power export

RoCoF Non-Detection Zone

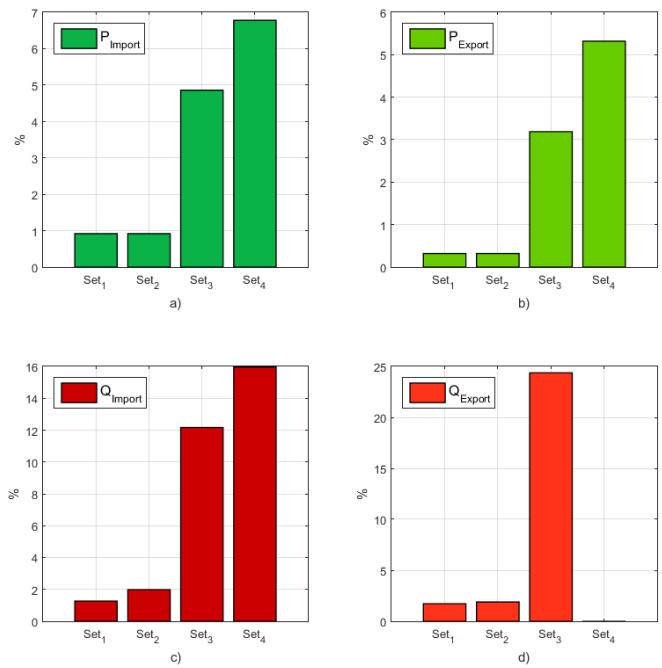

Figure 32. ROCOF NDZs for Generation Mix 4, a) Active power import, b) Active power export, c) Reactive power import, d) reactive power export

G59/3 Non-Detection Zone

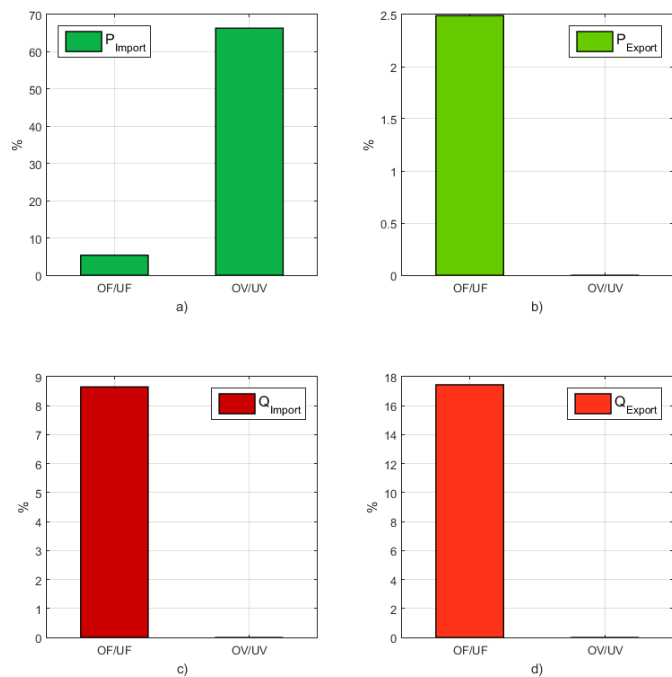

Figure 33. OF,UF,OV,UV NDZs for Generation Mix 4, a) Active power import, b) Active power export, c) Reactive power import, d) reactive power export

RoCoF Non-Detection Zone

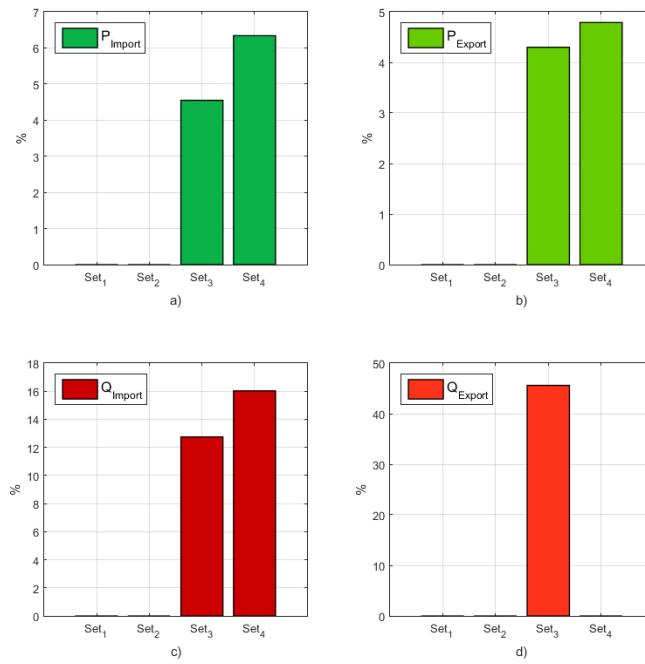

Figure 34. ROCOF NDZs for Generation Mix 5, a) Active power import, b) Active power export, c) Reactive power import, d) reactive power export

G59/3 Non-Detection Zone

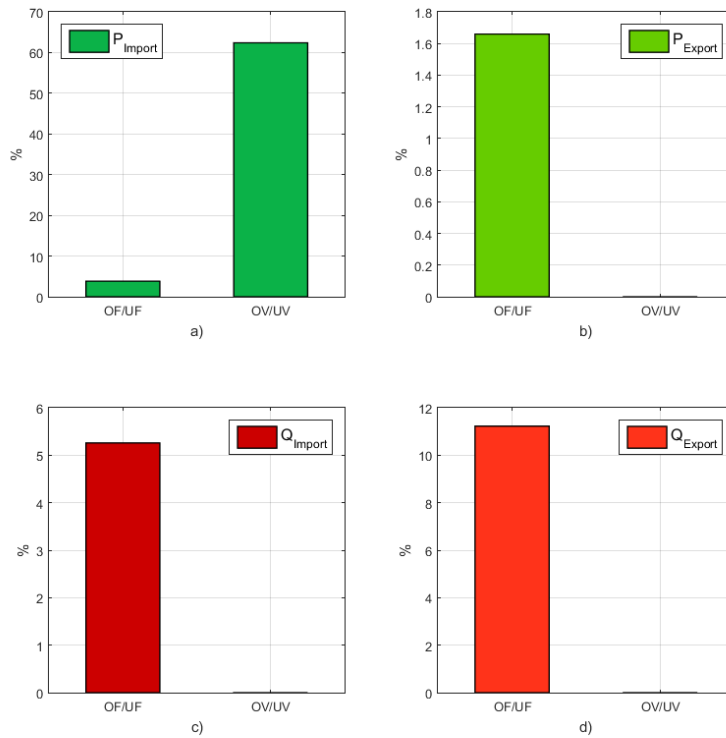

Figure 35. OF,UF,OV,UV NDZs for Generation Mix 5, a) Active power import, b) Active power export, c) Reactive power import, d) reactive power export

RoCoF Non-Detection Zone

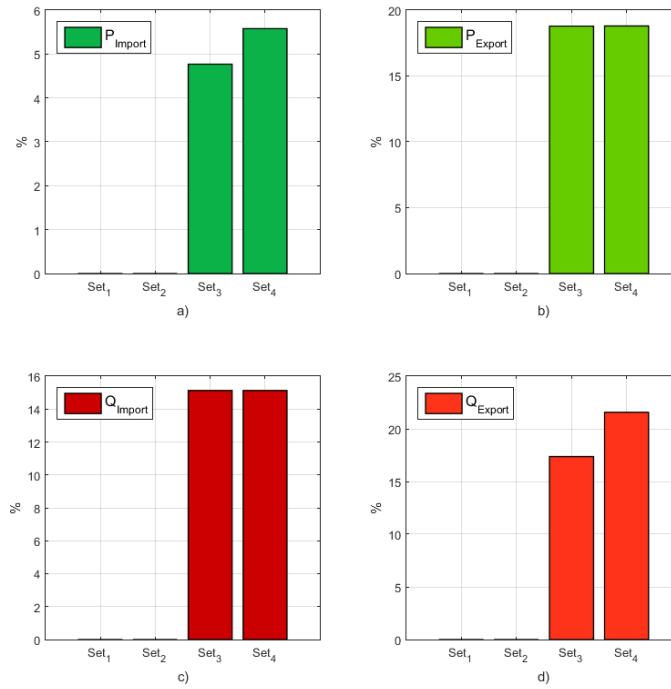

Figure 36.ROCOF NDZs for Generation Mix 6, a) Active power import, b) Active power export, c) Reactive power import, d) reactive power export

G59/3 Non-Detection Zone

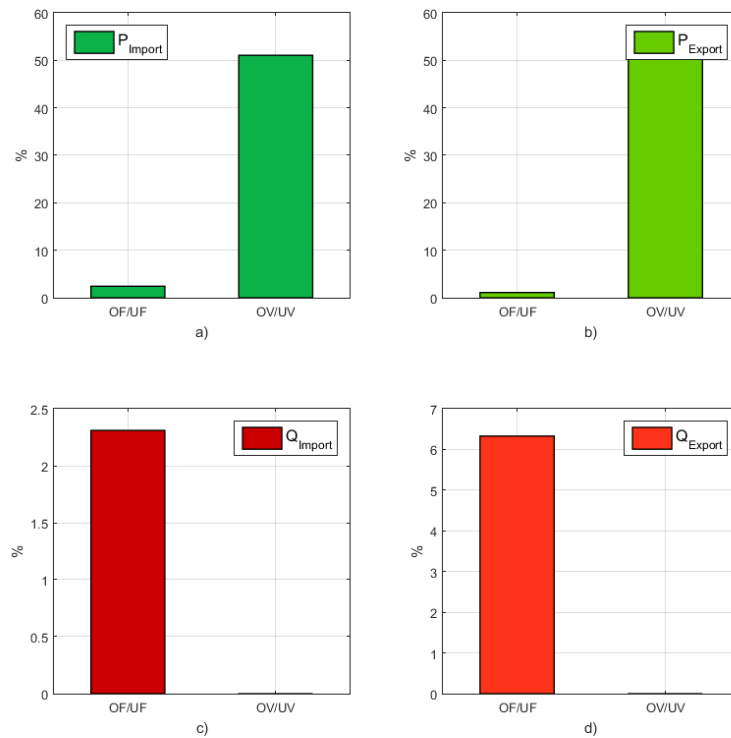

Figure 37. OF,UF,OV,UV NDZs for Generation Mix 6, a) Active power import, b) Active power export, c) Reactive power import, d) reactive power export

RoCoF Non-Detection Zone

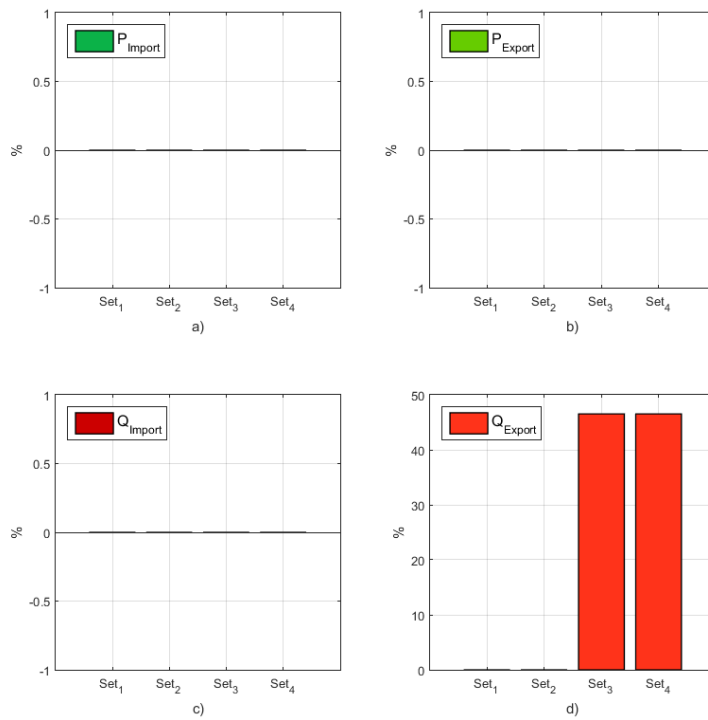

Figure 38. ROCOF NDZs for Generation Mix 7, a) Active power import, b) Active power export, c) Reactive power import, d) reactive power export

G59/3 Non-Detection Zone

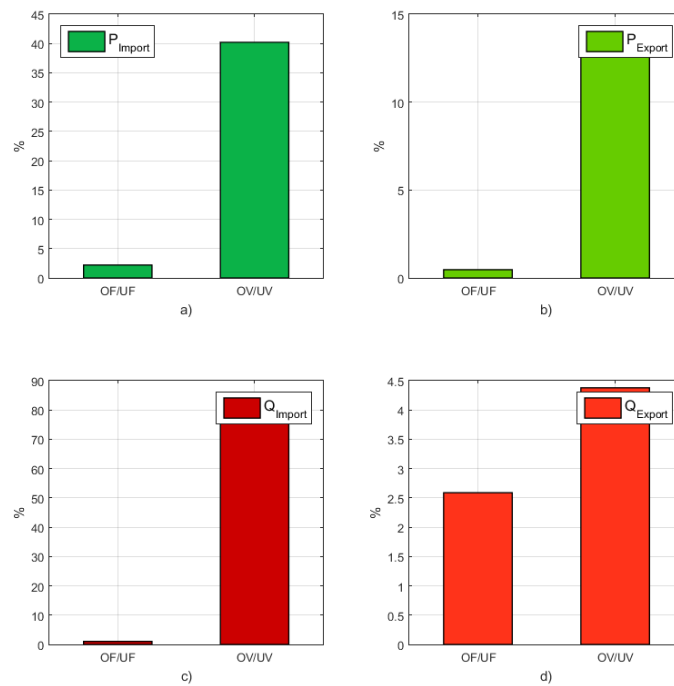

Figure 39. OF,UF,OV,UV NDZs for Generation Mix 7, a) Active power import, b) Active power export, c) Reactive power import, d) reactive power export

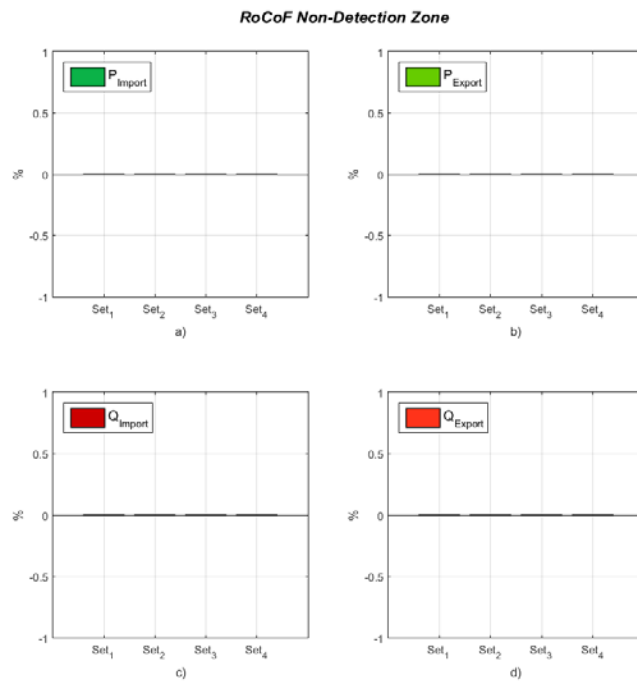

Figure 40. ROCOF NDZs for Generation Mix 8, a) Active power import, b) Active power export, c) Reactive power import, d) reactive power export

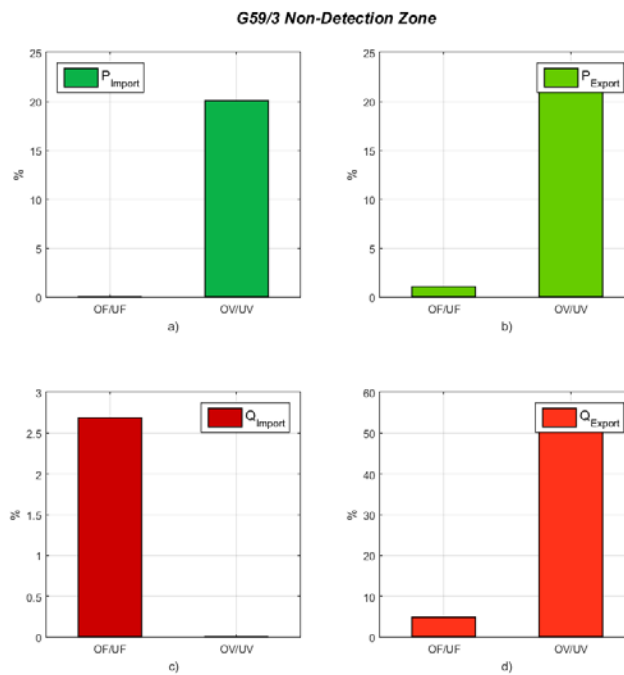

Figure 41. OF,UF,OV,UV NDZs for Generation Mix 8, a) Active power import, b) Active power export, c) Reactive power import, d) reactive power export

RoCoF Non-Detection Zone

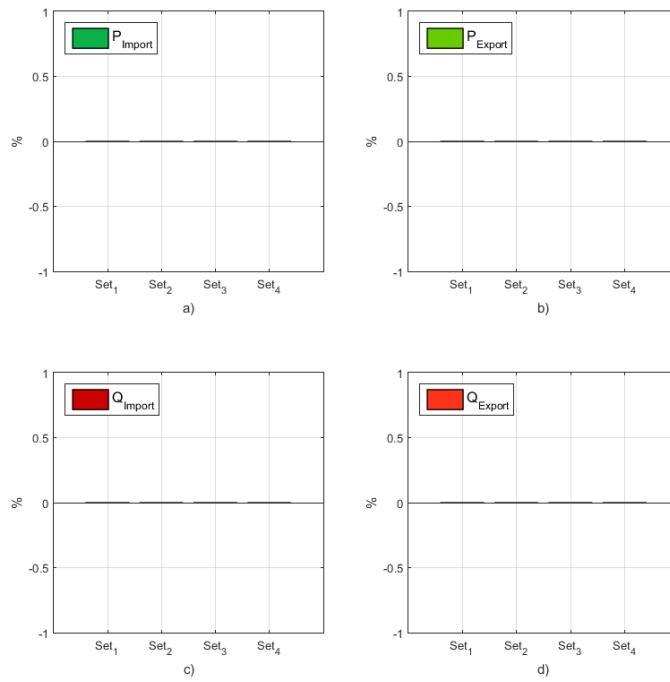

Figure 42. ROCOF NDZs for Generation Mix 9, a) Active power import, b) Active power export, c) Reactive power import, d) reactive power export

G59/3 Non-Detection Zone

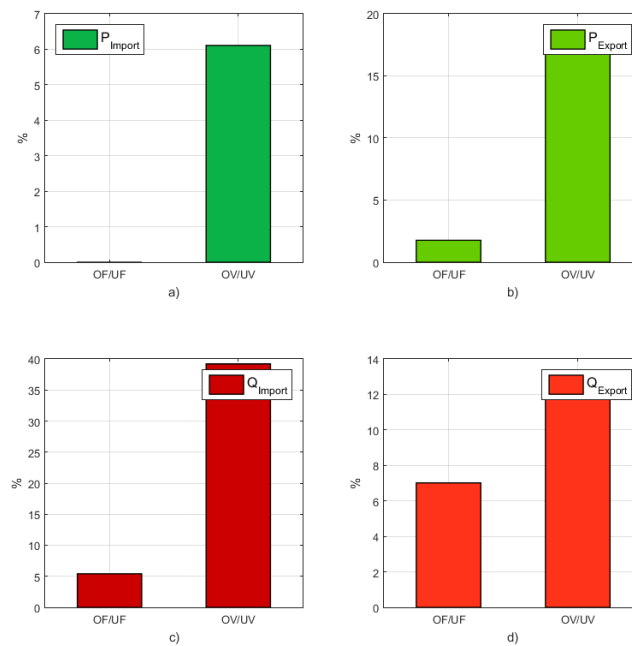

Figure 43. OF,UF,OV,UV NDZs for Generation Mix 9, a) Active power import, b) Active power export, c) Reactive power import, d) reactive power export

RoCoF Non-Detection Zone

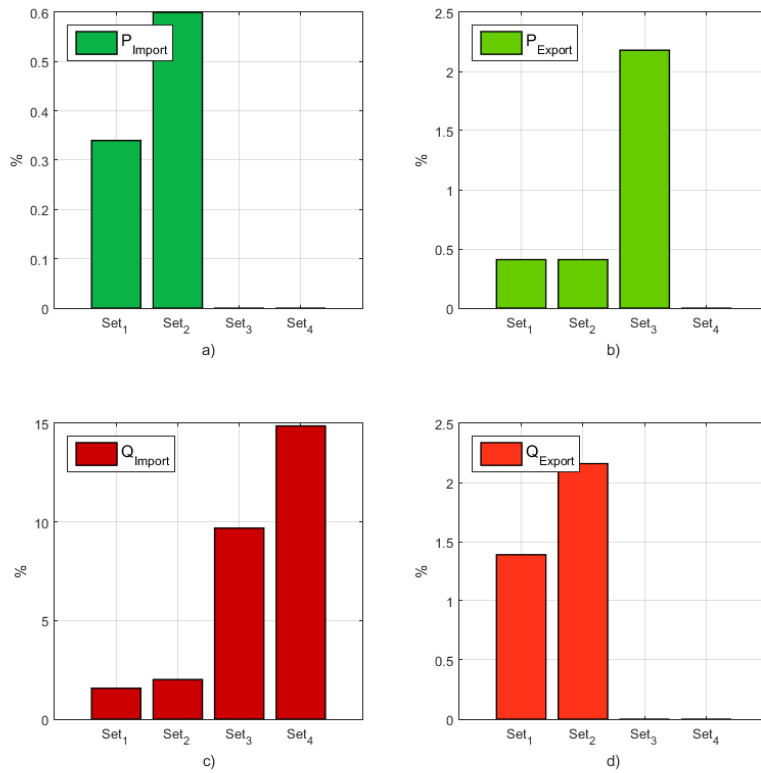

Figure 44. ROCOF NDZs for Generation Mix 10, a) Active power import, b) Active power export, c) Reactive power import, d) reactive power export

G59/3 Non-Detection Zone

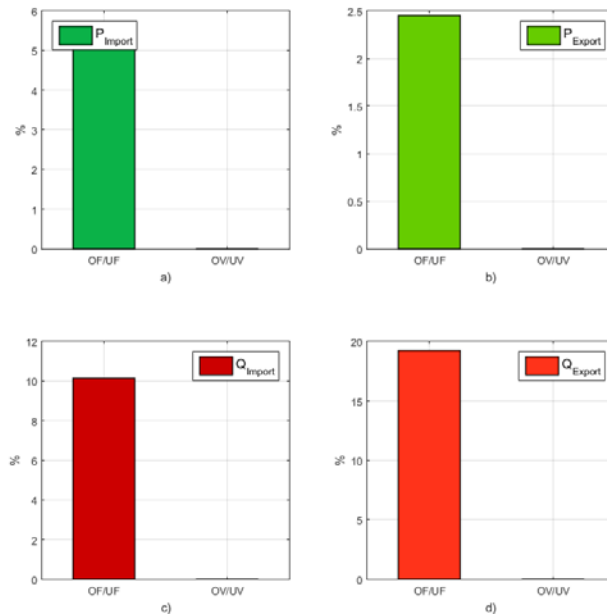

Figure 45. OF,UF,OV,UV NDZs for Generation Mix 10, a) Active power import, b) Active power export, c) Reactive power import, d) reactive power export

RoCoF Non-Detection Zone

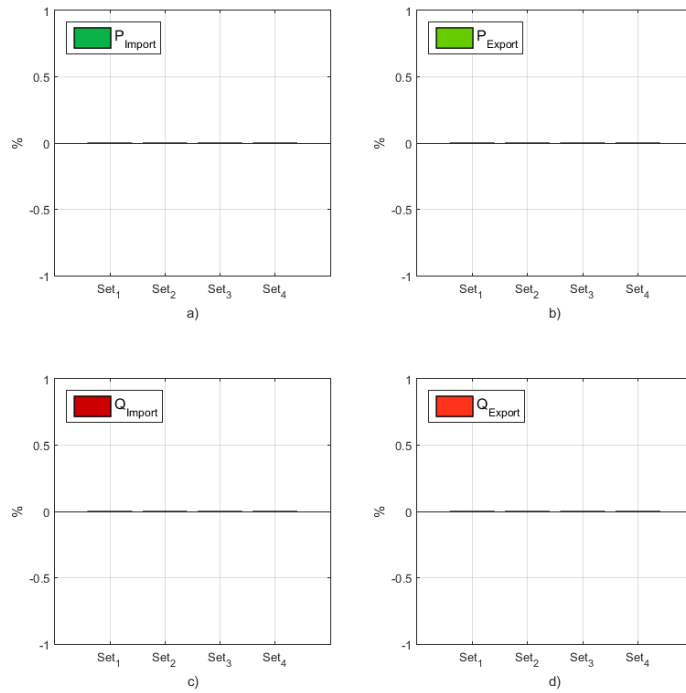

Figure 46. ROCOF NDZs for Generation Mix 11, a) Active power import, b) Active power export, c) Reactive power import, d) reactive power export

G59/3 Non-Detection Zone

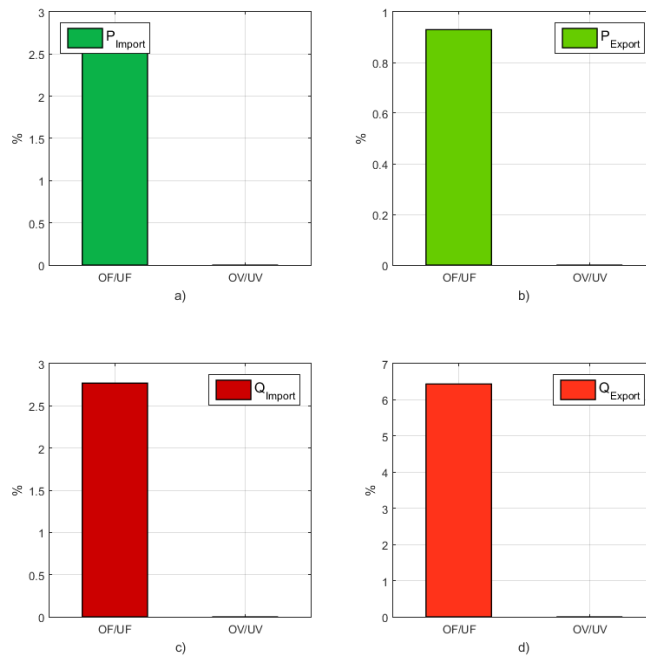

Figure 47. ROCOF NDZs for Generation Mix 11, a) Active power import, b) Active power export, c) Reactive power import, d) reactive power export

RoCoF Non-Detection Zone

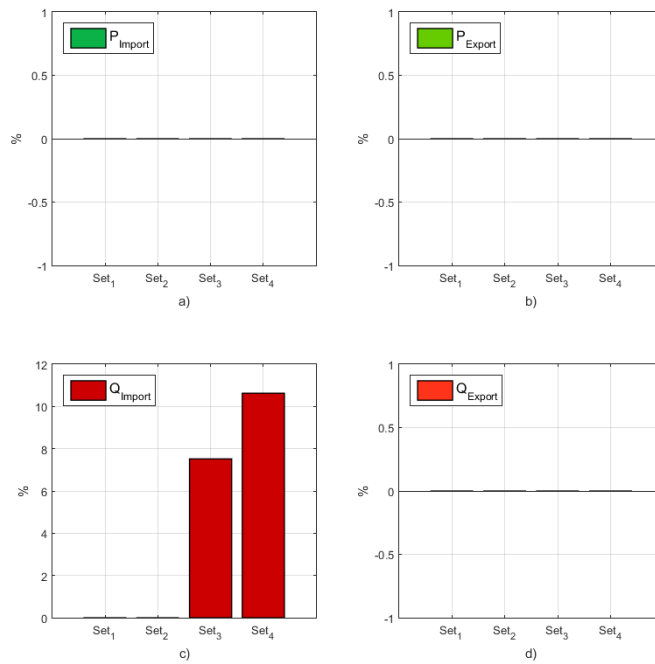

Figure 48. ROCOF NDZs for Generation Mix 12, a) Active power import, b) Active power export, c) Reactive power import, d) reactive power export

G59/3 Non-Detection Zone

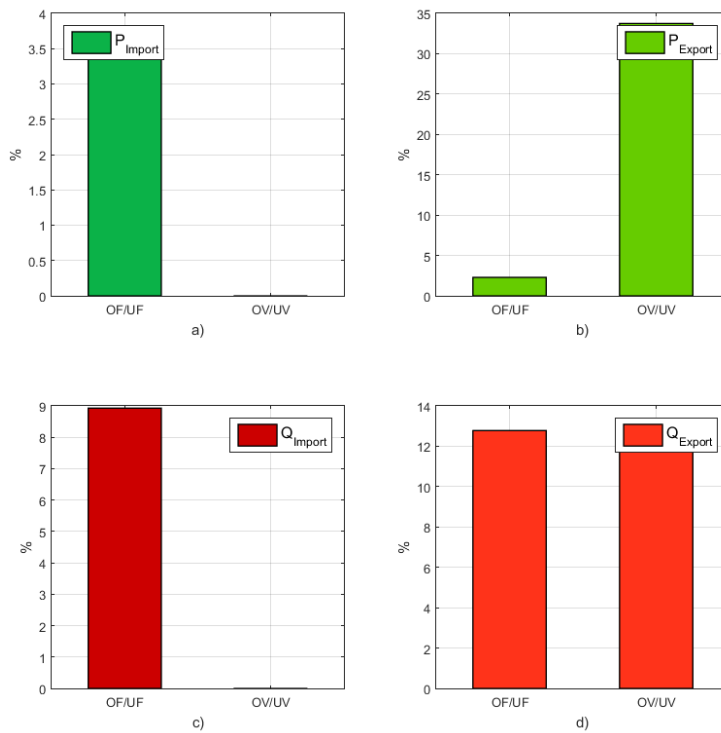

Figure 49. OF,UF,OV,UV NDZs for Generation Mix 12, a) Active power import, b) Active power export, c) Reactive power import, d) reactive power export

Appendix C: Full record of risk assessment results

C.1. Summary Results

Table 39. LOM risk assessment results for islanding scenario 1 (loss of supply to primary substation)

Load Profile	Setting Option	$T_{NDZavr,s1}$ [min]	$N_{LOM,1DGG,s1}$	$P_{LOM,1DGG,s1}$	$P_{LOM,s1}$
LP1b	1	6.53	4.88E-06	1.72E-12	2.98E-09
	2	7.48	7.35E-06	3.07E-12	5.33E-09
	3	75.16	8.44E-05	3.97E-11	6.26E-08
	4	90.20	1.31E-04	5.93E-11	9.66E-08
LP2	1	0.00	0.00E+00	0.00E+00	-0.00E+00
	2	0.08	1.00E-09	5.47E-17	8.34E-14
	3	122.46	5.47E-05	3.18E-11	4.02E-08
	4	138.86	8.27E-05	4.67E-11	6.13E-08
LP3	1	2.54	2.37E-08	1.08E-14	1.68E-11
	2	1.88	7.34E-08	2.11E-14	3.27E-11
	3	58.23	1.45E-04	7.91E-11	1.07E-07
	4	64.06	2.37E-04	1.22E-10	1.76E-07
LP4	1	0.00	0.00E+00	0.00E+00	-0.00E+00
	2	0.00	0.00E+00	0.00E+00	-0.00E+00
	3	69.45	2.29E-04	1.42E-10	1.70E-07
	4	75.34	4.59E-04	2.87E-10	3.40E-07
LP5	1	1.97	1.21E-07	8.30E-15	1.34E-11
	2	2.13	2.02E-07	1.46E-14	2.41E-11
	3	58.81	1.12E-03	7.01E-10	8.27E-07
	4	62.70	1.48E-03	9.28E-10	1.09E-06

Table 40. LOM risk assessment results for islanding scenario 2 (loss of individual HV circuit)

Load Profile	Setting Option	$T_{NDZavr,s2}$ [min]	$N_{LOM,1DGG,s2}$	$P_{LOM,1DGG,s2}$	$P_{LOM,s2}$
LP5	1	1.70	1.75E-05	1.97E-12	8.46E-09
	2	1.82	2.40E-05	2.85E-12	1.23E-08
	3	42.73	1.69E-02	1.04E-08	3.37E-05
	4	49.51	3.33E-02	2.08E-08	6.67E-05
LP6	1	1.26	8.70E-06	5.36E-13	2.38E-09
	2	1.37	1.48E-05	9.70E-13	4.39E-09
	3	55.43	1.39E-02	8.32E-09	2.76E-05
	4	60.26	1.94E-02	1.18E-08	3.89E-05
LP3	1	3.47	1.45E-06	3.81E-13	1.77E-09
	2	3.87	1.61E-06	4.81E-13	2.23E-09
	3	16.60	1.84E-03	9.20E-10	3.68E-06
	4	21.15	1.18E-02	5.14E-09	2.37E-05
LP4	1	0.00	0.00E+00	0.00E+00	-0.00E+00
	2	0.00	0.00E+00	0.00E+00	-0.00E+00
	3	69.64	3.84E-03	2.35E-09	7.57E-06
	4	72.96	6.01E-03	3.53E-09	1.13E-05
LP1a	1	4.48	2.33E-04	8.25E-11	3.88E-07
	2	5.28	4.78E-04	2.01E-10	9.49E-07
	3	25.48	9.75E-03	4.20E-09	1.96E-05
	4	39.54	1.81E-02	7.73E-09	3.63E-05

Table 41. Summary LOM risk assessment results – based on maximum load profile figures

LOM Scenario	Setting Option	T_{NDZavr} [min]	$N_{LOM,1DGG}$	$P_{LOM,1DGG}$	P_{LOM}
S1	1	6.5	4.88E-06	1.72E-12	2.98E-09
	2	7.5	7.35E-06	3.07E-12	5.33E-09
	3	122.5	1.12E-03	7.01E-10	8.27E-07
	4	138.9	1.48E-03	9.28E-10	1.09E-06
S2	1	4.48	2.33E-04	8.25E-11	3.88E-07
	2	5.28	4.78E-04	2.01E-10	9.49E-07
	3	69.64	1.69E-02	1.04E-08	3.37E-05
	4	72.96	3.33E-02	2.08E-08	6.67E-05
Combined S1 & S2	1	5.03	1.71E-04	6.07E-11	3.91E-07
	2	5.88	3.51E-04	1.48E-10	9.54E-07
	3	83.90	1.26E-02	7.77E-09	3.45E-05
	4	90.75	2.47E-02	1.54E-08	6.78E-05

Table 42. Summary LOM risk assessment results – based on average load profile figures

LOM Scenario	Setting Option	T_{NDZavr} [min]	$N_{LOM,1DGG}$	$P_{LOM,1DGG}$	P_{LOM}
S1	1	2.21	1.00E-06	3.48E-13	6.02E-10
	2	2.31	1.52E-06	6.21E-13	1.08E-09
	3	76.82	3.27E-04	1.99E-10	2.41E-07
	4	86.23	4.78E-04	2.89E-10	3.54E-07
S2	1	2.18	5.21E-05	1.71E-11	8.00E-08
	2	2.47	1.04E-04	4.11E-11	1.94E-07
	3	41.98	9.24E-03	5.24E-09	1.84E-05
	4	48.69	1.77E-02	9.79E-09	3.54E-05
Combined S1 & S2	1	2.19	3.83E-05	1.26E-11	8.06E-08
	2	2.43	7.61E-05	3.02E-11	1.95E-07
	3	51.38	6.84E-03	3.88E-09	1.87E-05
	4	58.82	1.31E-02	7.22E-09	3.57E-05

C.2. Detailed results for different generation mixes and load profiles

Table 43. LOM risk assessment results (islanding scenario 1, load profile LP1b)

Generation Mix (<i>m</i>)	Setting Option	$T_{NDZavr(m)}$ [min]	$N_{LOM,1DGG(m)}$	$P_{LOM,1DGG(m)}$	$N_{LOM(m)}$	$P_{LOM(m)}$
1	1	19.66	1.96E-05	6.91E-12	5.11E-03	2.70E-09
	2	23.54	3.01E-05	1.27E-11	7.83E-03	4.97E-09
	3	66.98	2.21E-04	9.35E-11	5.75E-02	3.65E-08
	4	131.92	4.20E-04	1.78E-10	1.09E-01	6.93E-08
2	1	0.00	0.00E+00	-0.00E+00	0.00E+00	-0.00E+00
	2	0.00	0.00E+00	-0.00E+00	0.00E+00	-0.00E+00
	3	0.00	0.00E+00	-0.00E+00	0.00E+00	-0.00E+00
	4	0.00	0.00E+00	-0.00E+00	0.00E+00	-0.00E+00
3	1	0.00	0.00E+00	-0.00E+00	0.00E+00	-0.00E+00
	2	0.00	0.00E+00	-0.00E+00	0.00E+00	-0.00E+00
	3	20.23	2.29E-06	1.45E-12	2.76E-04	1.75E-10
	4	17.37	1.17E-05	5.31E-12	1.40E-03	6.40E-10
4	1	18.83	4.27E-06	1.61E-12	5.25E-04	2.63E-10
	2	19.14	5.08E-06	1.95E-12	6.25E-04	3.20E-10
	3	134.43	1.15E-04	5.45E-11	1.41E-02	8.94E-09
	4	142.37	1.23E-04	5.84E-11	1.51E-02	9.58E-09
5	1	0.00	0.00E+00	-0.00E+00	0.00E+00	-0.00E+00
	2	0.00	0.00E+00	-0.00E+00	0.00E+00	-0.00E+00
	3	131.90	7.50E-05	3.96E-11	1.02E-02	6.50E-09
	4	131.90	7.50E-05	3.96E-11	1.02E-02	6.50E-09
6	1	0.00	0.00E+00	-0.00E+00	0.00E+00	-0.00E+00
	2	0.00	0.00E+00	-0.00E+00	0.00E+00	-0.00E+00
	3	151.68	5.20E-05	3.03E-11	7.82E-03	4.96E-09
	4	151.68	5.20E-05	3.03E-11	7.82E-03	4.96E-09
7	1	0.00	0.00E+00	-0.00E+00	0.00E+00	-0.00E+00
	2	0.00	0.00E+00	-0.00E+00	0.00E+00	-0.00E+00
	3	0.00	0.00E+00	-0.00E+00	0.00E+00	-0.00E+00
	4	0.00	0.00E+00	-0.00E+00	0.00E+00	-0.00E+00
8	1	0.00	0.00E+00	-0.00E+00	0.00E+00	-0.00E+00
	2	0.00	0.00E+00	-0.00E+00	0.00E+00	-0.00E+00
	3	85.03	1.18E-04	7.51E-11	6.53E-03	4.14E-09
	4	85.03	1.18E-04	7.51E-11	6.53E-03	4.14E-09
9	1	0.00	0.00E+00	-0.00E+00	0.00E+00	-0.00E+00
	2	0.00	0.00E+00	-0.00E+00	0.00E+00	-0.00E+00
	3	30.55	6.19E-06	3.92E-12	3.41E-04	2.17E-10
	4	30.55	6.19E-06	3.92E-12	3.41E-04	2.17E-10
10	1	10.91	3.88E-06	7.46E-13	7.04E-05	1.77E-11
	2	14.13	7.11E-06	1.92E-12	1.29E-04	4.55E-11
	3	102.14	9.55E-05	4.64E-11	1.73E-03	1.10E-09
	4	106.72	1.00E-04	4.86E-11	1.81E-03	1.15E-09
11	1	0.00	0.00E+00	-0.00E+00	0.00E+00	-0.00E+00
	2	0.00	0.00E+00	-0.00E+00	0.00E+00	-0.00E+00
	3	67.38	4.26E-07	2.57E-13	9.58E-06	6.08E-12
	4	67.38	4.26E-07	2.57E-13	9.58E-06	6.08E-12
12	1	0.00	0.00E+00	-0.00E+00	0.00E+00	-0.00E+00
	2	0.00	0.00E+00	-0.00E+00	0.00E+00	-0.00E+00
	3	38.22	2.42E-06	1.46E-12	5.43E-05	3.44E-11
	11	36.09	3.32E-06	2.00E-12	7.46E-05	4.73E-11

Table 44. LOM risk assessment results (islanding scenario 1, load profile LP2)

Generation Mix (<i>m</i>)	Setting Option	$T_{NDZavr(m)}$ [min]	$N_{LOM,1DGG(m)}$	$P_{LOM,1DGG(m)}$	$N_{LOM(m)}$	$P_{LOM(m)}$
1	1	0.00	0.00E+00	-0.00E+00	0.00E+00	-0.00E+00
	2	0.00	0.00E+00	-0.00E+00	0.00E+00	-0.00E+00
	3	26.25	4.43E-06	1.87E-12	1.15E-03	7.32E-10
	4	97.48	6.76E-05	2.86E-11	1.76E-02	1.12E-08
2	1	0.00	0.00E+00	-0.00E+00	0.00E+00	-0.00E+00
	2	0.00	0.00E+00	-0.00E+00	0.00E+00	-0.00E+00
	3	248.68	8.10E-06	5.14E-12	1.21E-03	7.66E-10
	4	248.68	8.10E-06	5.14E-12	1.21E-03	7.66E-10
3	1	0.00	0.00E+00	-0.00E+00	0.00E+00	-0.00E+00
	2	0.00	0.00E+00	-0.00E+00	0.00E+00	-0.00E+00
	3	18.48	1.80E-05	8.81E-12	2.16E-03	1.06E-09
	4	21.18	1.43E-04	9.07E-11	1.72E-02	1.09E-08
4	1	0.00	0.00E+00	-0.00E+00	0.00E+00	-0.00E+00
	2	0.00	0.00E+00	-0.00E+00	0.00E+00	-0.00E+00
	3	136.21	7.06E-05	3.36E-11	8.68E-03	5.50E-09
	4	140.50	7.26E-05	3.46E-11	8.93E-03	5.67E-09
5	1	0.00	0.00E+00	-0.00E+00	0.00E+00	-0.00E+00
	2	0.00	0.00E+00	-0.00E+00	0.00E+00	-0.00E+00
	3	145.45	5.84E-05	3.09E-11	7.98E-03	5.06E-09
	4	145.45	5.84E-05	3.09E-11	7.98E-03	5.06E-09
6	1	0.00	0.00E+00	-0.00E+00	0.00E+00	-0.00E+00
	2	0.00	0.00E+00	-0.00E+00	0.00E+00	-0.00E+00
	3	187.17	2.26E-05	1.31E-11	3.39E-03	2.15E-09
	4	187.17	2.26E-05	1.31E-11	3.39E-03	2.15E-09
7	1	0.00	0.00E+00	-0.00E+00	0.00E+00	-0.00E+00
	2	0.00	0.00E+00	-0.00E+00	0.00E+00	-0.00E+00
	3	67.10	4.56E-06	2.89E-12	2.52E-04	1.60E-10
	4	67.10	4.56E-06	2.89E-12	2.52E-04	1.60E-10
8	1	0.00	0.00E+00	-0.00E+00	0.00E+00	-0.00E+00
	2	0.00	0.00E+00	-0.00E+00	0.00E+00	-0.00E+00
	3	309.76	3.09E-04	1.96E-10	1.71E-02	1.08E-08
	4	309.76	3.09E-04	1.96E-10	1.71E-02	1.08E-08
9	1	0.00	0.00E+00	-0.00E+00	0.00E+00	-0.00E+00
	2	0.00	0.00E+00	-0.00E+00	0.00E+00	-0.00E+00
	3	86.34	2.21E-04	1.40E-10	1.22E-02	7.74E-09
	4	86.34	2.21E-04	1.40E-10	1.22E-02	7.74E-09
10	1	0.00	0.00E+00	-0.00E+00	0.00E+00	-0.00E+00
	2	5.25	6.44E-08	3.52E-15	1.17E-06	8.34E-14
	3	82.69	8.69E-05	4.22E-11	1.58E-03	9.99E-10
	4	77.67	1.06E-04	5.15E-11	1.92E-03	1.22E-09
11	1	0.00	0.00E+00	-0.00E+00	0.00E+00	-0.00E+00
	2	0.00	0.00E+00	-0.00E+00	0.00E+00	-0.00E+00
	3	127.02	6.31E-05	3.80E-11	1.42E-03	8.99E-10
	4	127.02	6.31E-05	3.80E-11	1.42E-03	8.99E-10
12	1	0.00	0.00E+00	-0.00E+00	0.00E+00	-0.00E+00
	2	0.00	0.00E+00	-0.00E+00	0.00E+00	-0.00E+00
	3	100.72	3.05E-04	1.84E-10	6.87E-03	4.35E-09
	11	94.45	3.29E-04	1.98E-10	7.39E-03	4.68E-09

Table 45. LOM risk assessment results (islanding scenario 1, load profile LP3)

Generation Mix (<i>m</i>)	Setting Option	$T_{NDZavr(m)}$ [min]	$N_{LOM,1DGG(m)}$	$P_{LOM,1DGG(m)}$	$N_{LOM(m)}$	$P_{LOM(m)}$
1	1	0.00	0.00E+00	-0.00E+00	0.00E+00	-0.00E+00
	2	0.00	0.00E+00	-0.00E+00	0.00E+00	-0.00E+00
	3	23.97	2.98E-05	1.26E-11	7.75E-03	4.92E-09
	4	47.92	3.59E-04	1.52E-10	9.35E-02	5.93E-08
2	1	0.00	0.00E+00	-0.00E+00	0.00E+00	-0.00E+00
	2	0.00	0.00E+00	-0.00E+00	0.00E+00	-0.00E+00
	3	0.00	0.00E+00	-0.00E+00	0.00E+00	-0.00E+00
	4	0.00	0.00E+00	-0.00E+00	0.00E+00	-0.00E+00
3	1	0.00	0.00E+00	-0.00E+00	0.00E+00	-0.00E+00
	2	0.00	0.00E+00	-0.00E+00	0.00E+00	-0.00E+00
	3	17.57	3.00E-05	1.39E-11	3.61E-03	1.67E-09
	4	21.44	1.79E-04	1.14E-10	2.16E-02	1.37E-08
4	1	22.50	2.08E-07	9.90E-14	2.56E-05	1.62E-11
	2	16.16	5.36E-07	1.68E-13	6.59E-05	2.75E-11
	3	60.22	3.32E-04	1.58E-10	4.08E-02	2.59E-08
	4	61.43	3.58E-04	1.70E-10	4.40E-02	2.79E-08
5	1	0.00	0.00E+00	-0.00E+00	0.00E+00	-0.00E+00
	2	0.00	0.00E+00	-0.00E+00	0.00E+00	-0.00E+00
	3	79.48	2.06E-04	1.09E-10	2.82E-02	1.79E-08
	4	79.48	2.06E-04	1.09E-10	2.82E-02	1.79E-08
6	1	0.00	0.00E+00	-0.00E+00	0.00E+00	-0.00E+00
	2	0.00	0.00E+00	-0.00E+00	0.00E+00	-0.00E+00
	3	113.06	1.68E-04	9.79E-11	2.53E-02	1.61E-08
	4	113.06	1.68E-04	9.79E-11	2.53E-02	1.61E-08
7	1	0.00	0.00E+00	-0.00E+00	0.00E+00	-0.00E+00
	2	0.00	0.00E+00	-0.00E+00	0.00E+00	-0.00E+00
	3	22.84	5.09E-06	3.23E-12	2.81E-04	1.78E-10
	4	22.84	5.09E-06	3.23E-12	2.81E-04	1.78E-10
8	1	0.00	0.00E+00	-0.00E+00	0.00E+00	-0.00E+00
	2	0.00	0.00E+00	-0.00E+00	0.00E+00	-0.00E+00
	3	267.18	5.01E-04	3.18E-10	2.76E-02	1.75E-08
	4	267.18	5.01E-04	3.18E-10	2.76E-02	1.75E-08
9	1	0.00	0.00E+00	-0.00E+00	0.00E+00	-0.00E+00
	2	0.00	0.00E+00	-0.00E+00	0.00E+00	-0.00E+00
	3	65.78	2.93E-04	1.86E-10	1.62E-02	1.03E-08
	4	65.78	2.93E-04	1.86E-10	1.62E-02	1.03E-08
10	1	11.00	1.13E-07	2.19E-14	2.04E-06	5.18E-13
	2	11.24	1.09E-06	2.18E-13	1.98E-05	5.17E-12
	3	51.09	6.93E-04	3.37E-10	1.26E-02	7.98E-09
	4	53.27	7.29E-04	3.54E-10	1.32E-02	8.38E-09
11	1	0.00	0.00E+00	-0.00E+00	0.00E+00	-0.00E+00
	2	0.00	0.00E+00	-0.00E+00	0.00E+00	-0.00E+00
	3	95.95	4.43E-05	2.67E-11	9.96E-04	6.32E-10
	4	95.95	4.43E-05	2.67E-11	9.96E-04	6.32E-10
12	1	0.00	0.00E+00	-0.00E+00	0.00E+00	-0.00E+00
	2	0.00	0.00E+00	-0.00E+00	0.00E+00	-0.00E+00
	3	75.96	2.79E-04	1.68E-10	6.26E-03	3.97E-09
	11	72.91	2.91E-04	1.75E-10	6.55E-03	4.15E-09

Table 46. LOM risk assessment results (islanding scenario 1, load profile LP4)

Generation Mix (<i>m</i>)	Setting Option	$T_{NDZavr(m)}$ [min]	$N_{LOM,1DGG(m)}$	$P_{LOM,1DGG(m)}$	$N_{LOM(m)}$	$P_{LOM(m)}$
1	1	0.00	0.00E+00	-0.00E+00	0.00E+00	-0.00E+00
	2	0.00	0.00E+00	-0.00E+00	0.00E+00	-0.00E+00
	3	4.80	3.11E-07	1.18E-14	8.09E-05	4.62E-12
	4	19.00	6.24E-06	2.11E-12	1.62E-03	8.24E-10
2	1	0.00	0.00E+00	-0.00E+00	0.00E+00	-0.00E+00
	2	0.00	0.00E+00	-0.00E+00	0.00E+00	-0.00E+00
	3	188.69	5.12E-05	3.24E-11	7.63E-03	4.84E-09
	4	188.69	5.12E-05	3.24E-11	7.63E-03	4.84E-09
3	1	0.00	0.00E+00	-0.00E+00	0.00E+00	-0.00E+00
	2	0.00	0.00E+00	-0.00E+00	0.00E+00	-0.00E+00
	3	30.85	1.02E-04	6.47E-11	1.23E-02	7.79E-09
	4	61.26	2.29E-03	1.45E-09	2.76E-01	1.75E-07
4	1	0.00	0.00E+00	-0.00E+00	0.00E+00	-0.00E+00
	2	0.00	0.00E+00	-0.00E+00	0.00E+00	-0.00E+00
	3	26.68	6.54E-06	3.11E-12	8.04E-04	5.10E-10
	4	23.27	9.13E-06	4.34E-12	1.12E-03	7.12E-10
5	1	0.00	0.00E+00	-0.00E+00	0.00E+00	-0.00E+00
	2	0.00	0.00E+00	-0.00E+00	0.00E+00	-0.00E+00
	3	25.17	1.42E-05	7.51E-12	1.94E-03	1.23E-09
	4	25.17	1.42E-05	7.51E-12	1.94E-03	1.23E-09
6	1	0.00	0.00E+00	-0.00E+00	0.00E+00	-0.00E+00
	2	0.00	0.00E+00	-0.00E+00	0.00E+00	-0.00E+00
	3	56.98	1.79E-04	1.04E-10	2.69E-02	1.70E-08
	4	56.98	1.79E-04	1.04E-10	2.69E-02	1.70E-08
7	1	0.00	0.00E+00	-0.00E+00	0.00E+00	-0.00E+00
	2	0.00	0.00E+00	-0.00E+00	0.00E+00	-0.00E+00
	3	126.08	3.02E-04	1.91E-10	1.66E-02	1.06E-08
	4	126.08	3.02E-04	1.91E-10	1.66E-02	1.06E-08
8	1	0.00	0.00E+00	-0.00E+00	0.00E+00	-0.00E+00
	2	0.00	0.00E+00	-0.00E+00	0.00E+00	-0.00E+00
	3	235.71	1.27E-03	8.05E-10	7.00E-02	4.44E-08
	4	235.71	1.27E-03	8.05E-10	7.00E-02	4.44E-08
9	1	0.00	0.00E+00	-0.00E+00	0.00E+00	-0.00E+00
	2	0.00	0.00E+00	-0.00E+00	0.00E+00	-0.00E+00
	3	173.84	1.13E-03	7.19E-10	6.25E-02	3.97E-08
	4	173.84	1.13E-03	7.19E-10	6.25E-02	3.97E-08
10	1	0.00	0.00E+00	-0.00E+00	0.00E+00	-0.00E+00
	2	0.00	0.00E+00	-0.00E+00	0.00E+00	-0.00E+00
	3	23.96	4.42E-06	2.15E-12	8.01E-05	5.08E-11
	4	22.01	6.45E-06	3.14E-12	1.17E-04	7.42E-11
11	1	0.00	0.00E+00	-0.00E+00	0.00E+00	-0.00E+00
	2	0.00	0.00E+00	-0.00E+00	0.00E+00	-0.00E+00
	3	63.47	7.13E-04	4.30E-10	1.60E-02	1.02E-08
	4	63.47	7.13E-04	4.30E-10	1.60E-02	1.02E-08
12	1	0.00	0.00E+00	-0.00E+00	0.00E+00	-0.00E+00
	2	0.00	0.00E+00	-0.00E+00	0.00E+00	-0.00E+00
	3	59.42	2.34E-03	1.41E-09	5.26E-02	3.33E-08
	11	58.18	2.53E-03	1.52E-09	5.69E-02	3.61E-08

Table 47. LOM risk assessment results (islanding scenario 1, load profile LP5)

Generation Mix (<i>m</i>)	Setting Option	$T_{NDZavr(m)}$ [min]	$N_{LOM,1DGG(m)}$	$P_{LOM,1DGG(m)}$	$N_{LOM(m)}$	$P_{LOM(m)}$
1	1	5.38	2.32E-07	1.16E-14	6.03E-05	4.55E-12
	2	6.13	5.01E-07	3.31E-14	1.30E-04	1.29E-11
	3	11.23	1.82E-05	3.16E-12	4.73E-03	1.23E-09
	4	20.30	4.11E-05	1.74E-11	1.07E-02	6.78E-09
2	1	0.00	0.00E+00	-0.00E+00	0.00E+00	-0.00E+00
	2	0.00	0.00E+00	-0.00E+00	0.00E+00	-0.00E+00
	3	44.73	4.57E-05	2.90E-11	6.81E-03	4.32E-09
	4	44.73	4.57E-05	2.90E-11	6.81E-03	4.32E-09
3	1	0.00	0.00E+00	-0.00E+00	0.00E+00	-0.00E+00
	2	0.00	0.00E+00	-0.00E+00	0.00E+00	-0.00E+00
	3	125.76	3.14E-03	1.99E-09	3.78E-01	2.40E-07
	4	142.61	6.56E-03	4.16E-09	7.90E-01	5.01E-07
4	1	6.46	6.40E-07	5.27E-14	7.87E-05	8.65E-12
	2	6.36	7.98E-07	6.37E-14	9.81E-05	1.04E-11
	3	19.20	6.54E-05	2.52E-11	8.05E-03	4.14E-09
	4	20.54	6.81E-05	3.24E-11	8.38E-03	5.31E-09
5	1	0.00	0.00E+00	-0.00E+00	0.00E+00	-0.00E+00
	2	0.00	0.00E+00	-0.00E+00	0.00E+00	-0.00E+00
	3	19.85	1.86E-04	8.31E-11	2.55E-02	1.36E-08
	4	19.85	1.86E-04	8.31E-11	2.55E-02	1.36E-08
6	1	0.00	0.00E+00	-0.00E+00	0.00E+00	-0.00E+00
	2	0.00	0.00E+00	-0.00E+00	0.00E+00	-0.00E+00
	3	25.75	3.28E-04	1.90E-10	4.93E-02	3.12E-08
	4	25.75	3.28E-04	1.90E-10	4.93E-02	3.12E-08
7	1	0.00	0.00E+00	-0.00E+00	0.00E+00	-0.00E+00
	2	0.00	0.00E+00	-0.00E+00	0.00E+00	-0.00E+00
	3	192.61	1.37E-03	8.71E-10	7.58E-02	4.81E-08
	4	192.61	1.37E-03	8.71E-10	7.58E-02	4.81E-08
8	1	0.00	0.00E+00	-0.00E+00	0.00E+00	-0.00E+00
	2	0.00	0.00E+00	-0.00E+00	0.00E+00	-0.00E+00
	3	233.60	8.07E-03	5.12E-09	4.45E-01	2.82E-07
	4	233.60	8.07E-03	5.12E-09	4.45E-01	2.82E-07
9	1	0.00	0.00E+00	-0.00E+00	0.00E+00	-0.00E+00
	2	0.00	0.00E+00	-0.00E+00	0.00E+00	-0.00E+00
	3	172.02	4.99E-03	3.16E-09	2.75E-01	1.75E-07
	4	172.02	4.99E-03	3.16E-09	2.75E-01	1.75E-07
10	1	5.85	1.46E-07	1.01E-14	2.65E-06	2.39E-13
	2	6.16	4.19E-07	3.22E-14	7.59E-06	7.62E-13
	3	18.65	2.28E-05	8.67E-12	4.13E-04	2.05E-10
	4	19.09	2.41E-05	9.44E-12	4.38E-04	2.23E-10
11	1	0.00	0.00E+00	-0.00E+00	0.00E+00	-0.00E+00
	2	0.00	0.00E+00	-0.00E+00	0.00E+00	-0.00E+00
	3	36.89	5.01E-04	3.02E-10	1.13E-02	7.15E-09
	4	36.89	5.01E-04	3.02E-10	1.13E-02	7.15E-09
12	1	0.00	0.00E+00	-0.00E+00	0.00E+00	-0.00E+00
	2	0.00	0.00E+00	-0.00E+00	0.00E+00	-0.00E+00
	3	37.80	1.39E-03	8.36E-10	3.12E-02	1.98E-08
	11	37.12	1.40E-03	8.46E-10	3.15E-02	2.00E-08

Table 48. LOM risk assessment results (islanding scenario 2, load profile LP5)

Generation Mix (<i>m</i>)	Setting Option	$T_{NDZavr(m)}$ [min]	$N_{LOM,1DGG(m)}$	$P_{LOM,1DGG(m)}$	$N_{LOM(m)}$	$P_{LOM(m)}$
1	1	7.36	1.46E-05	1.35E-12	9.50E-03	1.31E-09
	2	7.91	2.77E-05	2.87E-12	1.80E-02	2.79E-09
	3	11.14	7.18E-04	1.24E-10	4.66E-01	1.20E-07
	4	19.43	1.59E-03	5.54E-10	1.03E+00	5.39E-07
2	1	0.00	0.00E+00	-0.00E+00	0.00E+00	-0.00E+00
	2	0.00	0.00E+00	-0.00E+00	0.00E+00	-0.00E+00
	3	44.59	1.64E-03	1.04E-09	2.78E+00	1.76E-06
	4	44.59	1.64E-03	1.04E-09	2.78E+00	1.76E-06
3	1	0.00	0.00E+00	-0.00E+00	0.00E+00	-0.00E+00
	2	0.00	0.00E+00	-0.00E+00	0.00E+00	-0.00E+00
	3	40.29	1.32E-02	8.39E-09	4.95E+00	3.14E-06
	4	82.93	1.50E-01	9.52E-08	5.62E+01	3.57E-05
4	1	7.92	6.09E-04	7.13E-11	4.58E-02	7.15E-09
	2	8.20	7.68E-04	9.49E-11	5.78E-02	9.52E-09
	3	23.60	3.08E-02	1.46E-08	2.32E+00	1.47E-06
	4	25.10	3.26E-02	1.55E-08	2.45E+00	1.55E-06
5	1	0.00	0.00E+00	-0.00E+00	0.00E+00	-0.00E+00
	2	0.00	0.00E+00	-0.00E+00	0.00E+00	-0.00E+00
	3	20.46	2.76E-02	1.46E-08	2.30E+00	1.46E-06
	4	20.46	2.76E-02	1.46E-08	2.30E+00	1.46E-06
6	1	0.00	0.00E+00	-0.00E+00	0.00E+00	-0.00E+00
	2	0.00	0.00E+00	-0.00E+00	0.00E+00	-0.00E+00
	3	29.00	3.74E-02	2.17E-08	3.44E+00	2.18E-06
	4	29.00	3.74E-02	2.17E-08	3.44E+00	2.18E-06
7	1	0.00	0.00E+00	-0.00E+00	0.00E+00	-0.00E+00
	2	0.00	0.00E+00	-0.00E+00	0.00E+00	-0.00E+00
	3	123.66	7.09E-02	4.50E-08	4.52E+00	2.87E-06
	4	123.66	7.09E-02	4.50E-08	4.52E+00	2.87E-06
8	1	0.00	0.00E+00	-0.00E+00	0.00E+00	-0.00E+00
	2	0.00	0.00E+00	-0.00E+00	0.00E+00	-0.00E+00
	3	212.60	3.01E-01	1.91E-07	1.92E+01	1.22E-05
	4	212.60	3.01E-01	1.91E-07	1.92E+01	1.22E-05
9	1	0.00	0.00E+00	-0.00E+00	0.00E+00	-0.00E+00
	2	0.00	0.00E+00	-0.00E+00	0.00E+00	-0.00E+00
	3	149.28	2.10E-01	1.33E-07	1.34E+01	8.48E-06
	11	149.28	2.10E-01	1.33E-07	1.34E+01	8.48E-06

Table 49. LOM risk assessment results (islanding scenario 2, load profile LP6)

Generation Mix (<i>m</i>)	Setting Option	$T_{NDZavr(m)}$ [min]	$N_{LOM,1DGG(m)}$	$P_{LOM,1DGG(m)}$	$N_{LOM(m)}$	$P_{LOM(m)}$
1	1	5.46	2.12E-05	1.10E-12	1.38E-02	1.07E-09
	2	5.99	4.44E-05	2.80E-12	2.88E-02	2.73E-09
	3	16.56	2.30E-03	6.61E-10	1.49E+00	6.43E-07
	4	32.76	4.44E-03	1.88E-09	2.88E+00	1.83E-06
2	1	0.00	0.00E+00	-0.00E+00	0.00E+00	-0.00E+00
	2	0.00	0.00E+00	-0.00E+00	0.00E+00	-0.00E+00
	3	66.75	1.14E-03	7.24E-10	1.94E+00	1.23E-06
	4	66.75	1.14E-03	7.24E-10	1.94E+00	1.23E-06
3	1	0.00	0.00E+00	-0.00E+00	0.00E+00	-0.00E+00
	2	0.00	0.00E+00	-0.00E+00	0.00E+00	-0.00E+00
	3	26.25	9.06E-03	5.75E-09	3.39E+00	2.15E-06
	4	38.30	5.12E-02	3.25E-08	1.92E+01	1.22E-05
4	1	5.99	1.83E-04	1.30E-11	1.38E-02	1.30E-09
	2	5.94	2.38E-04	1.66E-11	1.79E-02	1.67E-09
	3	40.85	4.40E-02	2.10E-08	3.31E+00	2.10E-06
	4	44.39	4.72E-02	2.24E-08	3.55E+00	2.25E-06
5	1	0.00	0.00E+00	-0.00E+00	0.00E+00	-0.00E+00
	2	0.00	0.00E+00	-0.00E+00	0.00E+00	-0.00E+00
	3	44.22	4.02E-02	2.12E-08	3.36E+00	2.13E-06
	4	44.22	4.02E-02	2.12E-08	3.36E+00	2.13E-06
6	1	0.00	0.00E+00	-0.00E+00	0.00E+00	-0.00E+00
	2	0.00	0.00E+00	-0.00E+00	0.00E+00	-0.00E+00
	3	51.27	3.58E-02	2.08E-08	3.29E+00	2.09E-06
	4	51.27	3.58E-02	2.08E-08	3.29E+00	2.09E-06
7	1	0.00	0.00E+00	-0.00E+00	0.00E+00	-0.00E+00
	2	0.00	0.00E+00	-0.00E+00	0.00E+00	-0.00E+00
	3	78.99	3.53E-02	2.24E-08	2.25E+00	1.43E-06
	4	78.99	3.53E-02	2.24E-08	2.25E+00	1.43E-06
8	1	0.00	0.00E+00	-0.00E+00	0.00E+00	-0.00E+00
	2	0.00	0.00E+00	-0.00E+00	0.00E+00	-0.00E+00
	3	246.18	2.39E-01	1.52E-07	1.52E+01	9.67E-06
	4	246.18	2.39E-01	1.52E-07	1.52E+01	9.67E-06
9	1	0.00	0.00E+00	-0.00E+00	0.00E+00	-0.00E+00
	2	0.00	0.00E+00	-0.00E+00	0.00E+00	-0.00E+00
	3	144.39	1.52E-01	9.61E-08	9.67E+00	6.13E-06
	11	144.39	1.52E-01	9.61E-08	9.67E+00	6.13E-06

Table 50. LOM risk assessment results (islanding scenario 2, load profile LP3)

Generation Mix (<i>m</i>)	Setting Option	$T_{NDZavr(m)}$ [min]	$N_{LOM,1DGG(m)}$	$P_{LOM,1DGG(m)}$	$N_{LOM(m)}$	$P_{LOM(m)}$
1	1	14.33	6.33E-06	1.52E-12	4.11E-03	1.48E-09
	2	17.00	6.16E-06	1.82E-12	3.99E-03	1.77E-09
	3	30.12	3.27E-03	1.38E-09	2.12E+00	1.35E-06
	4	46.50	5.17E-02	2.19E-08	3.35E+01	2.13E-05
2	1	0.00	0.00E+00	-0.00E+00	0.00E+00	-0.00E+00
	2	0.00	0.00E+00	-0.00E+00	0.00E+00	-0.00E+00
	3	0.00	0.00E+00	-0.00E+00	0.00E+00	-0.00E+00
	4	0.00	0.00E+00	-0.00E+00	0.00E+00	-0.00E+00
3	1	0.00	0.00E+00	-0.00E+00	0.00E+00	-0.00E+00
	2	0.00	0.00E+00	-0.00E+00	0.00E+00	-0.00E+00
	3	7.00	0.00E+00	0.00E+00	0.00E+00	0.00E+00
	4	16.60	0.00E+00	0.00E+00	0.00E+00	0.00E+00
4	1	22.50	6.19E-06	2.94E-12	4.65E-04	2.95E-10
	2	16.16	1.44E-05	4.51E-12	1.08E-03	4.52E-10
	3	56.36	1.31E-02	6.21E-09	9.82E-01	6.23E-07
	4	58.69	1.45E-02	6.89E-09	1.09E+00	6.92E-07
5	1	0.00	0.00E+00	-0.00E+00	0.00E+00	-0.00E+00
	2	0.00	0.00E+00	-0.00E+00	0.00E+00	-0.00E+00
	3	75.96	1.40E-02	7.41E-09	1.17E+00	7.44E-07
	4	75.96	1.40E-02	7.41E-09	1.17E+00	7.44E-07
6	1	0.00	0.00E+00	-0.00E+00	0.00E+00	-0.00E+00
	2	0.00	0.00E+00	-0.00E+00	0.00E+00	-0.00E+00
	3	113.21	8.93E-03	5.19E-09	8.21E-01	5.21E-07
	4	113.21	8.93E-03	5.19E-09	8.21E-01	5.21E-07
7	1	0.00	0.00E+00	-0.00E+00	0.00E+00	-0.00E+00
	2	0.00	0.00E+00	-0.00E+00	0.00E+00	-0.00E+00
	3	0.00	0.00E+00	-0.00E+00	0.00E+00	-0.00E+00
	4	0.00	0.00E+00	-0.00E+00	0.00E+00	-0.00E+00
8	1	0.00	0.00E+00	-0.00E+00	0.00E+00	-0.00E+00
	2	0.00	0.00E+00	-0.00E+00	0.00E+00	-0.00E+00
	3	126.89	1.10E-02	6.97E-09	7.01E-01	4.45E-07
	4	126.89	1.10E-02	6.97E-09	7.01E-01	4.45E-07
9	1	0.00	0.00E+00	-0.00E+00	0.00E+00	-0.00E+00
	2	0.00	0.00E+00	-0.00E+00	0.00E+00	-0.00E+00
	3	19.31	1.19E-04	6.13E-11	7.56E-03	3.91E-09
	11	19.31	1.19E-04	6.13E-11	7.56E-03	3.91E-09

Table 51. LOM risk assessment results (islanding scenario 2, load profile LP4)

Generation Mix (<i>m</i>)	Setting Option	$T_{NDZavr(m)}$ [min]	$N_{LOM,1DGG(m)}$	$P_{LOM,1DGG(m)}$	$N_{LOM(m)}$	$P_{LOM(m)}$
1	1	0.00	0.00E+00	-0.00E+00	0.00E+00	-0.00E+00
	2	0.00	0.00E+00	-0.00E+00	0.00E+00	-0.00E+00
	3	4.80	5.79E-06	2.20E-13	3.76E-03	2.14E-10
	4	19.26	2.00E-04	6.88E-11	1.30E-01	6.69E-08
2	1	0.00	0.00E+00	-0.00E+00	0.00E+00	-0.00E+00
	2	0.00	0.00E+00	-0.00E+00	0.00E+00	-0.00E+00
	3	102.58	0.00E+00	0.00E+00	0.00E+00	0.00E+00
	4	102.58	0.00E+00	0.00E+00	0.00E+00	0.00E+00
3	1	0.00	0.00E+00	-0.00E+00	0.00E+00	-0.00E+00
	2	0.00	0.00E+00	-0.00E+00	0.00E+00	-0.00E+00
	3	16.03	1.64E-03	6.78E-10	6.14E-01	2.54E-07
	4	19.83	1.96E-02	1.04E-08	7.33E+00	3.91E-06
4	1	0.00	0.00E+00	-0.00E+00	0.00E+00	-0.00E+00
	2	0.00	0.00E+00	-0.00E+00	0.00E+00	-0.00E+00
	3	47.89	3.24E-03	1.54E-09	2.44E-01	1.55E-07
	4	44.04	3.42E-03	1.63E-09	2.58E-01	1.63E-07
5	1	0.00	0.00E+00	-0.00E+00	0.00E+00	-0.00E+00
	2	0.00	0.00E+00	-0.00E+00	0.00E+00	-0.00E+00
	3	50.43	6.40E-03	3.38E-09	5.35E-01	3.40E-07
	4	50.43	6.40E-03	3.38E-09	5.35E-01	3.40E-07
6	1	0.00	0.00E+00	-0.00E+00	0.00E+00	-0.00E+00
	2	0.00	0.00E+00	-0.00E+00	0.00E+00	-0.00E+00
	3	62.25	5.92E-03	3.44E-09	5.44E-01	3.45E-07
	4	62.25	5.92E-03	3.44E-09	5.44E-01	3.45E-07
7	1	0.00	0.00E+00	-0.00E+00	0.00E+00	-0.00E+00
	2	0.00	0.00E+00	-0.00E+00	0.00E+00	-0.00E+00
	3	38.68	2.40E-03	1.52E-09	1.53E-01	9.70E-08
	4	38.68	2.40E-03	1.52E-09	1.53E-01	9.70E-08
8	1	0.00	0.00E+00	-0.00E+00	0.00E+00	-0.00E+00
	2	0.00	0.00E+00	-0.00E+00	0.00E+00	-0.00E+00
	3	206.53	7.87E-02	4.99E-08	5.02E+00	3.19E-06
	4	206.53	7.87E-02	4.99E-08	5.02E+00	3.19E-06
9	1	0.00	0.00E+00	-0.00E+00	0.00E+00	-0.00E+00
	2	0.00	0.00E+00	-0.00E+00	0.00E+00	-0.00E+00
	3	122.69	7.89E-02	5.01E-08	5.04E+00	3.19E-06
	11	122.69	7.89E-02	5.01E-08	5.04E+00	3.19E-06

Table 52. LOM risk assessment results (islanding scenario 2, load profile LP1a)

Generation Mix (<i>m</i>)	Setting Option	$T_{NDZavr(m)}$ [min]	$N_{LOM,1DGG(m)}$	$P_{LOM,1DGG(m)}$	$N_{LOM(m)}$	$P_{LOM(m)}$
1	1	19.66	1.04E-03	3.67E-10	6.75E-01	3.57E-07
	2	23.54	2.21E-03	9.36E-10	1.44E+00	9.11E-07
	3	66.98	4.27E-02	1.81E-08	2.77E+01	1.76E-05
	4	131.92	8.32E-02	3.52E-08	5.39E+01	3.42E-05
2	1	0.00	0.00E+00	-0.00E+00	0.00E+00	-0.00E+00
	2	0.00	0.00E+00	-0.00E+00	0.00E+00	-0.00E+00
	3	0.00	0.00E+00	-0.00E+00	0.00E+00	-0.00E+00
	4	0.00	0.00E+00	-0.00E+00	0.00E+00	-0.00E+00
3	1	0.00	0.00E+00	-0.00E+00	0.00E+00	-0.00E+00
	2	0.00	0.00E+00	-0.00E+00	0.00E+00	-0.00E+00
	3	10.00	0.00E+00	0.00E+00	0.00E+00	0.00E+00
	4	14.64	0.00E+00	0.00E+00	0.00E+00	0.00E+00
4	1	18.83	8.15E-04	3.07E-10	6.13E-02	3.08E-08
	2	19.14	1.00E-03	3.84E-10	7.53E-02	3.85E-08
	3	134.43	2.47E-02	1.17E-08	1.86E+00	1.18E-06
	4	142.37	2.67E-02	1.27E-08	2.01E+00	1.27E-06
5	1	0.00	0.00E+00	-0.00E+00	0.00E+00	-0.00E+00
	2	0.00	0.00E+00	-0.00E+00	0.00E+00	-0.00E+00
	3	132.56	1.40E-02	7.40E-09	1.17E+00	7.42E-07
	4	132.56	1.40E-02	7.40E-09	1.17E+00	7.42E-07
6	1	0.00	0.00E+00	-0.00E+00	0.00E+00	-0.00E+00
	2	0.00	0.00E+00	-0.00E+00	0.00E+00	-0.00E+00
	3	95.31	9.52E-04	5.53E-10	8.75E-02	5.55E-08
	4	95.31	9.52E-04	5.53E-10	8.75E-02	5.55E-08
7	1	0.00	0.00E+00	-0.00E+00	0.00E+00	-0.00E+00
	2	0.00	0.00E+00	-0.00E+00	0.00E+00	-0.00E+00
	3	0.00	0.00E+00	-0.00E+00	0.00E+00	-0.00E+00
	4	0.00	0.00E+00	-0.00E+00	0.00E+00	-0.00E+00
8	1	0.00	0.00E+00	-0.00E+00	0.00E+00	-0.00E+00
	2	0.00	0.00E+00	-0.00E+00	0.00E+00	-0.00E+00
	3	36.29	1.52E-04	9.65E-11	9.71E-03	6.16E-09
	4	36.29	1.52E-04	9.65E-11	9.71E-03	6.16E-09
9	1	0.00	0.00E+00	-0.00E+00	0.00E+00	-0.00E+00
	2	0.00	0.00E+00	-0.00E+00	0.00E+00	-0.00E+00
	3	17.57	1.13E-05	5.21E-12	7.19E-04	3.32E-10
	11	17.57	1.13E-05	5.21E-12	7.19E-04	3.32E-10

C.3. Result figures

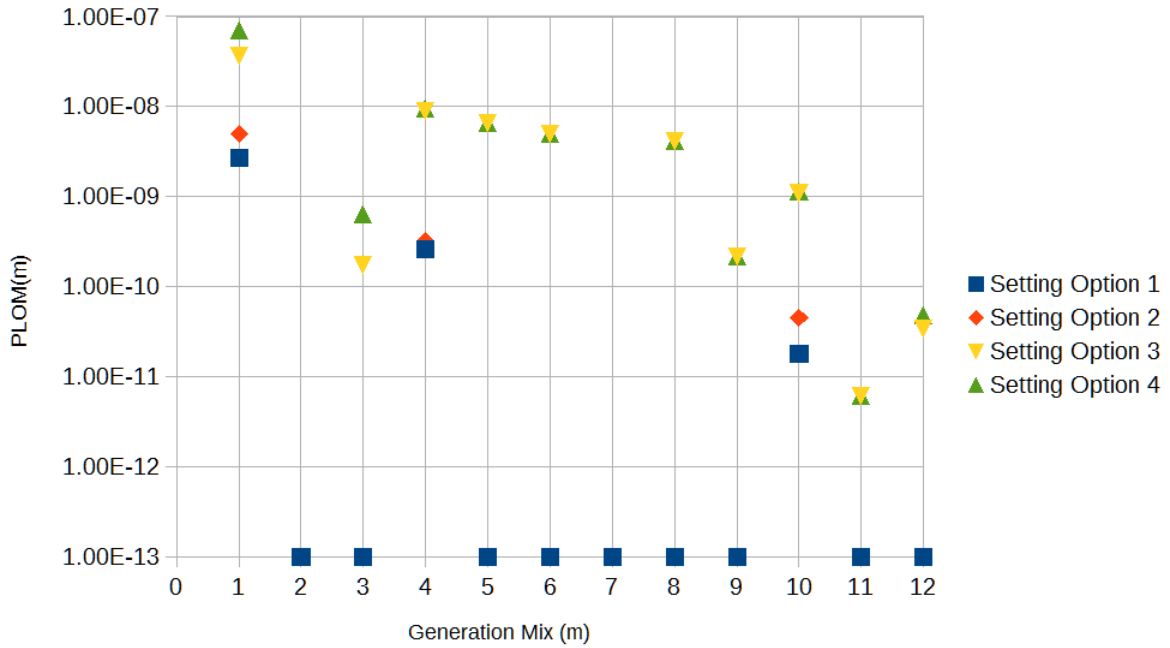

Figure 50. Probability of undetected islanding operation – Scenario 1, Load Profile LP1b

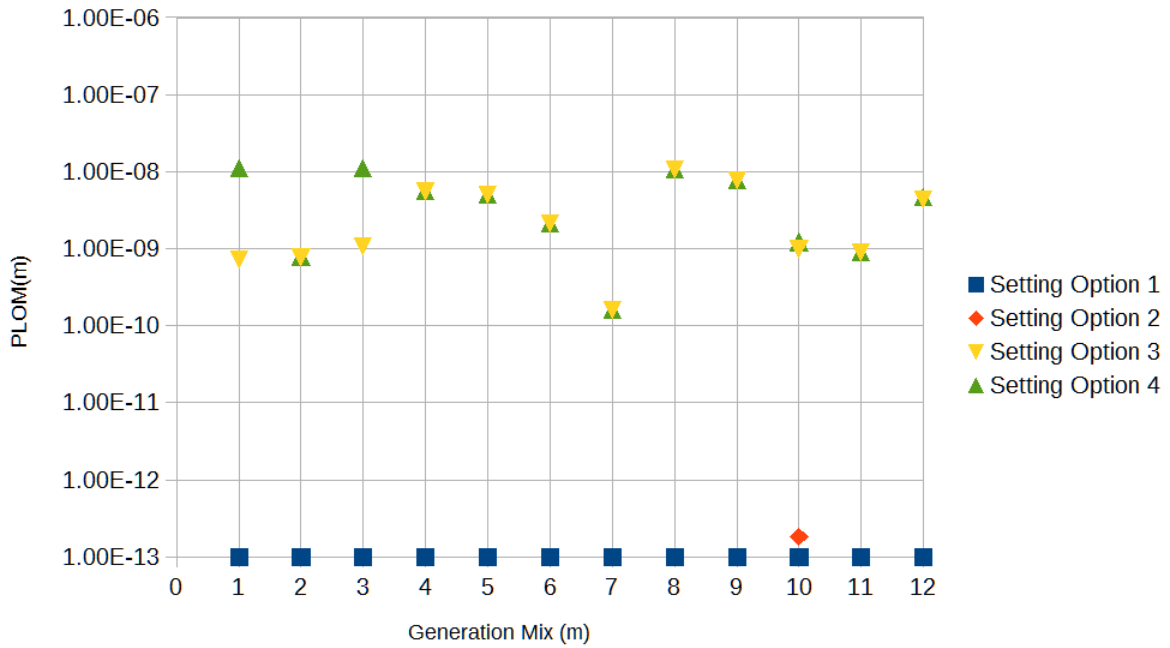

Figure 51. Probability of undetected islanding operation – Scenario 1, Load Profile LP2

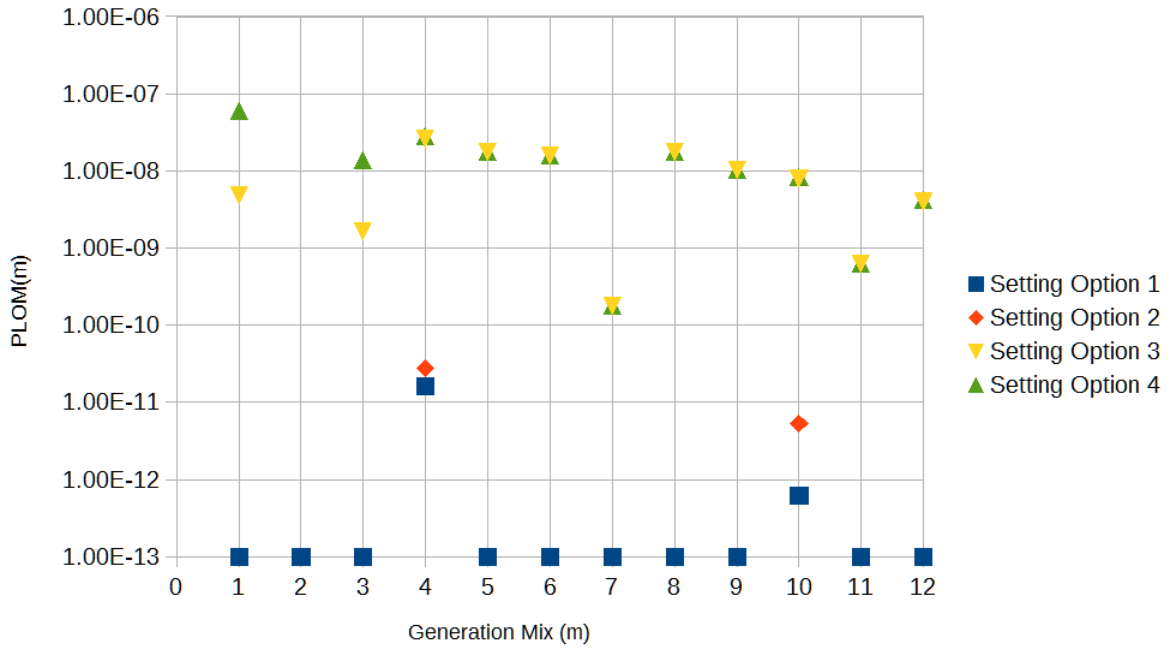

Figure 52. Probability of undetected islanding operation – Scenario 1, Load Profile LP3

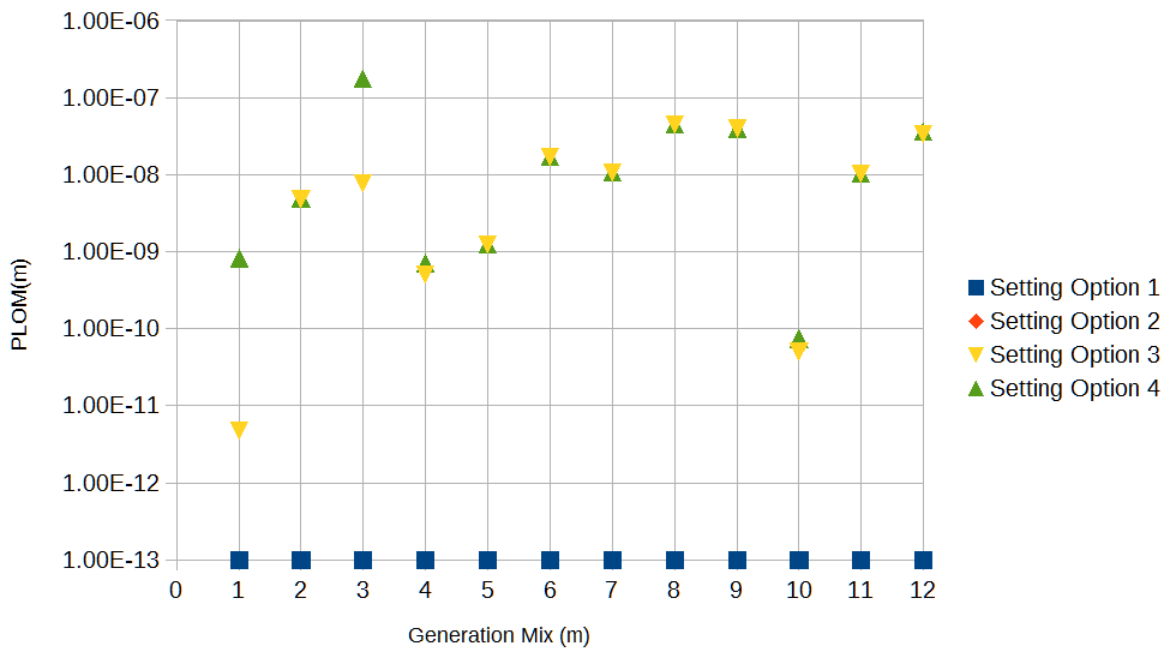

Figure 53. Probability of undetected islanding operation – Scenario 1, Load Profile LP4

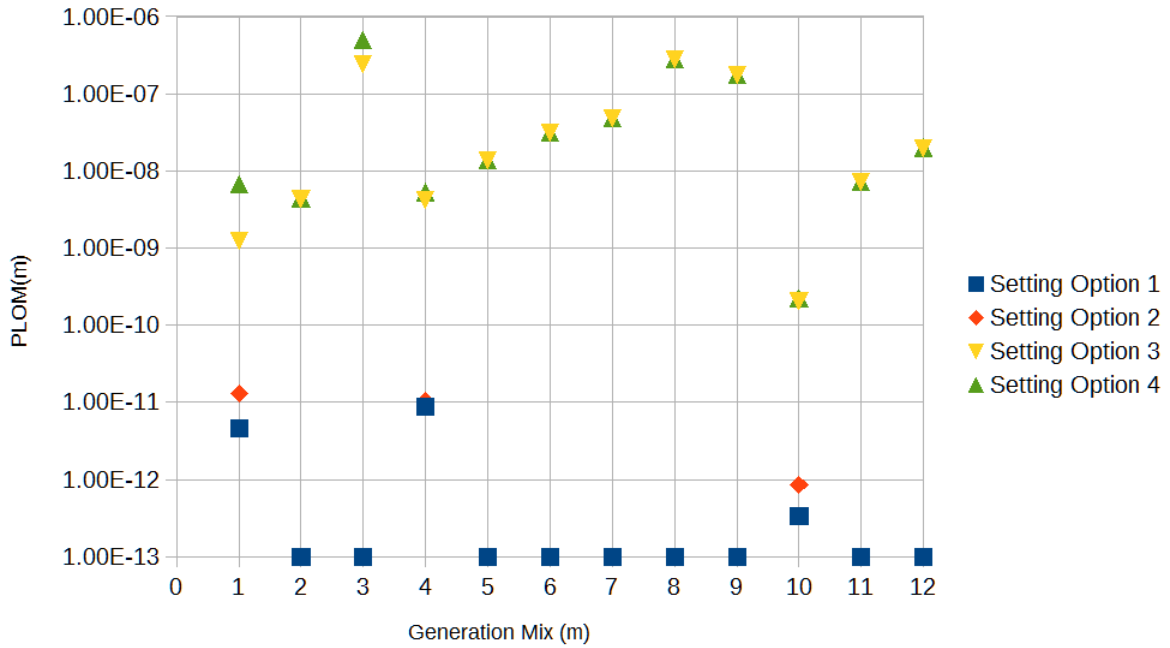

Figure 54. Probability of undetected islanding operation – Scenario 1, Load Profile LP5

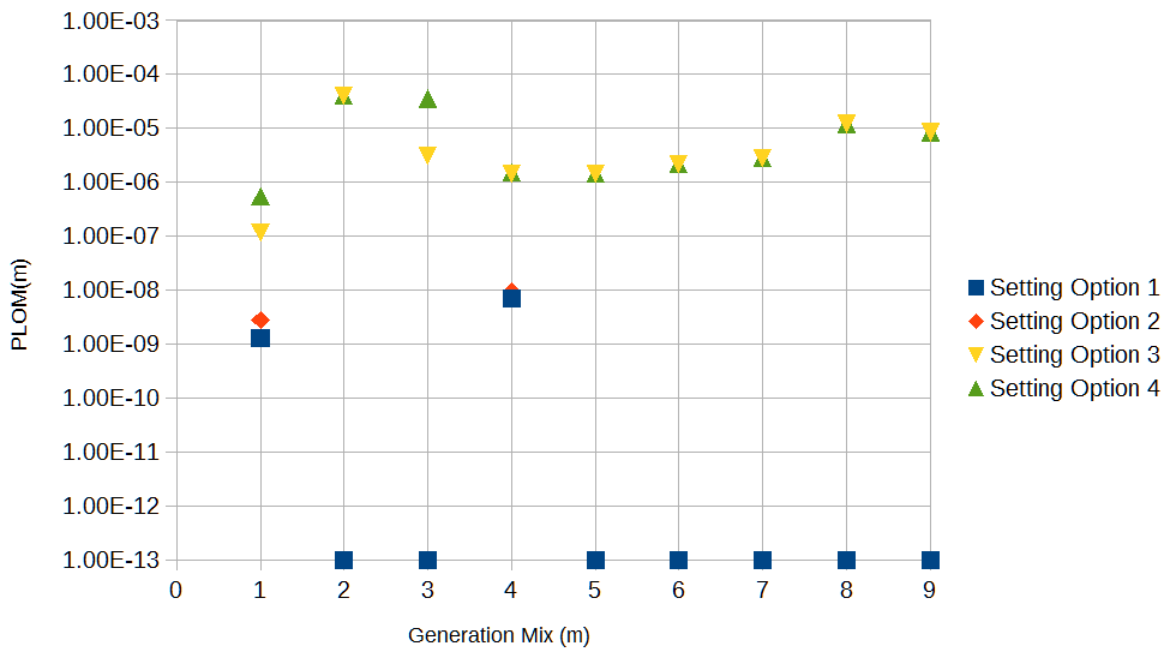

Figure 55. Probability of undetected islanding operation – Scenario 2, Load Profile LP5

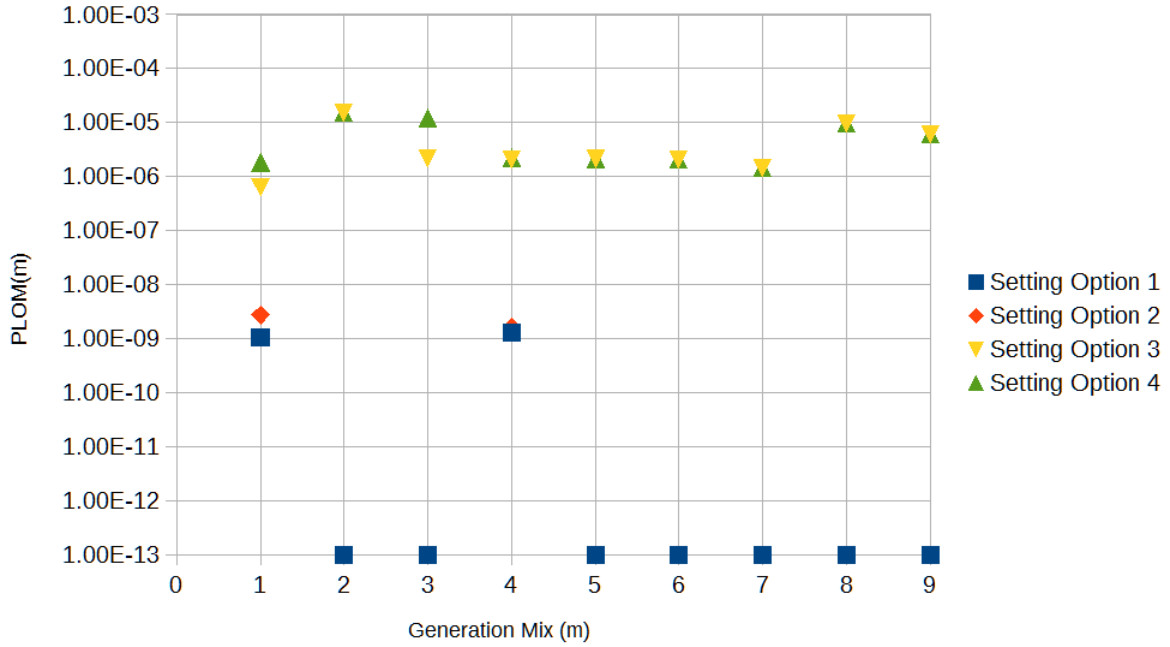

Figure 56. Probability of undetected islanding operation – Scenario 2, Load Profile LP6

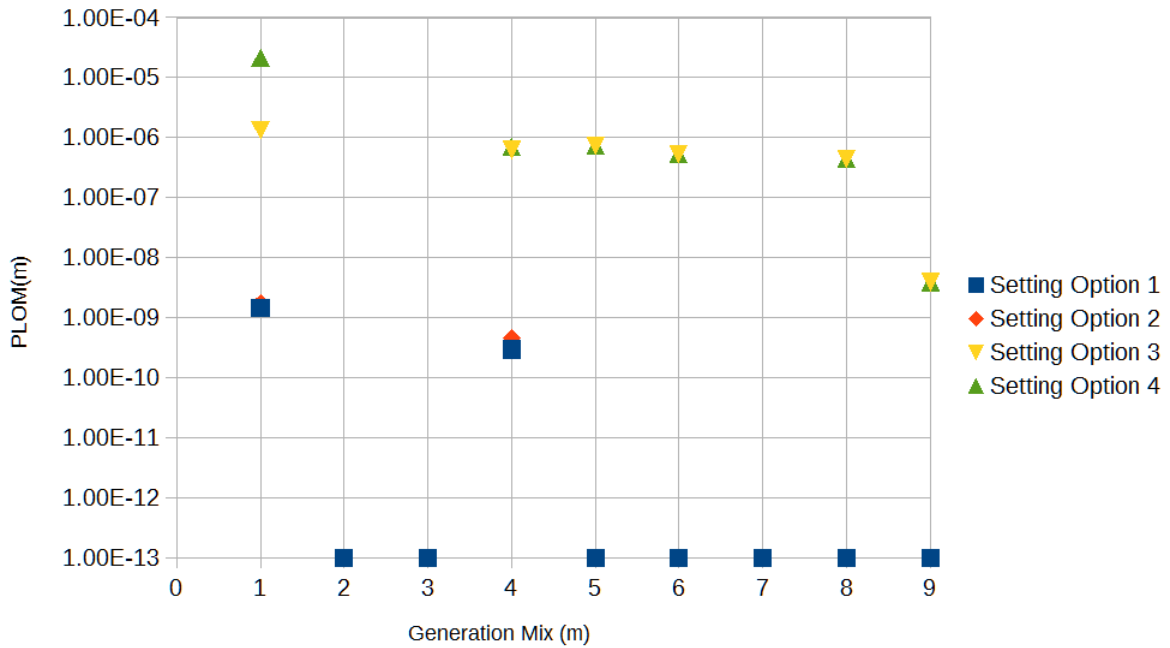

Figure 57. Probability of undetected islanding operation – Scenario 2, Load Profile LP3

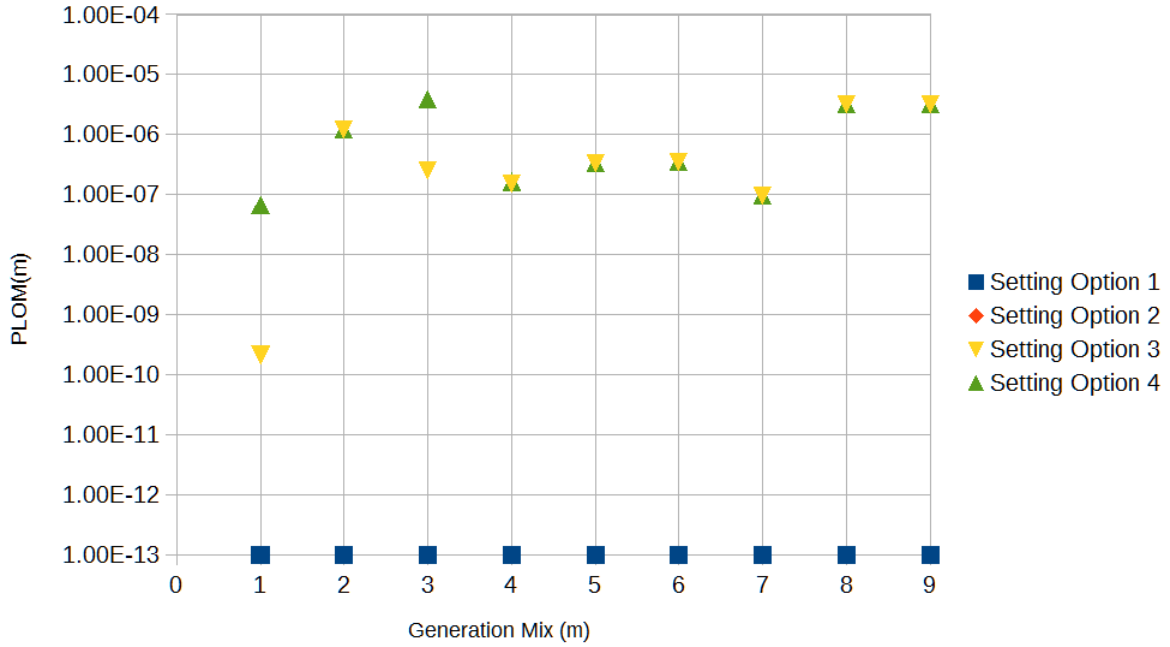

Figure 58. Probability of undetected islanding operation – Scenario 2, Load Profile LP4

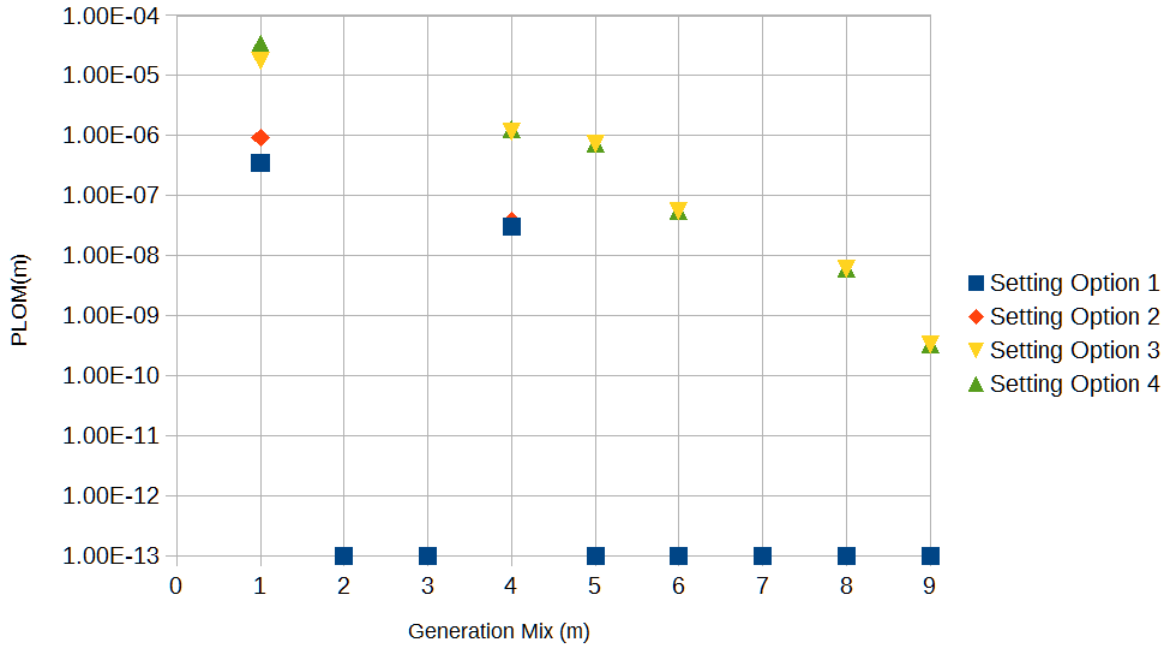

Figure 59. Probability of undetected islanding operation – Scenario 2, Load Profile LP1a

Appendix D: Terms of Reference

Consultancy/Research Proposal



Distributed Generation Operation in an Islanded Network

Introduction

The system inertia and therefore the potential rate of change of frequency after loss of an infeed or demand is likely to change given developments in the electricity supply system in Great Britain.

The Grid Code Review Panel (GCRP) in conjunction with Distribution Code Review Panel (DCRP) has been working on proposals for an appropriate Rate of Change of Frequency (RoCoF) setting for protection against Loss of Mains¹.

The Panels have established a joint working group which seeks proposals from organisations to investigate the characteristics and capabilities of generating facilities within Great Britain at sites with a registered capacity of less than 5MW. Experience is required in small and micro- generation and its deployment in large scales across electricity networks. The working group seeks an independent assessment of the numbers and types of distributed generators in Great Britain, their ability to withstand a frequency deviation and their stability in islanded operation.

Scope of Work

The research project must provide a technical report (the technical report will be published on National Grid's website and available to all parties) including:

1. The numbers, capacities and types of distributed generators in Great Britain at sites of less than 5MW in capacity
2. With respect to the types of distributed generators identified in 1:
 - a. The general characteristics of the technologies deployed;
 - b. The behaviour of the technologies deployed in an island situation both individually and as part of a mix of multiple generators;
 - c. The capability of the technologies deployed to withstand variations in frequency;
 - d. The Loss of Mains protection techniques used and in particular whether RoCoF based techniques are used, and if not formally RoCoF, how that LoM protection reacts to frequency deviations;
 - e. The actions and costs require to implement a new minimum RoCoF withstand performance requirement
3. Relevant international experience in anti-islanding protection for generators at sites of capacity of less than 5MW and of changing protection settings and/or withstand capability for future and existing installations.

Items 1-3 are the high level objectives of the technical report.

Organisations interested in this research project are therefore requested to provide a "formal proposal" including the milestones, and cost associated with each item. The expected completion date for the project is end of August 2014.

1

<http://www.nationalgrid.com/uk/Electricity/Codes/gridcode/workinggroups/Frequency+Change+s+during+Large+System+Disturbances/>

Distributed Generation (<5MW) RoCoF Settings

Introduction

The system inertia and therefore the potential rate of change of frequency after loss of an infeed or demand is likely to change given developments in the electricity supply system in Great Britain.

The Grid Code Review Panel (GCRP) and the Distribution Code Review Panel (DCRP) has been working on proposals for an appropriate Rate of Change of Frequency (RoCoF) setting for protection against Loss of Mains¹.

The Panels have established a joint working group which seeks proposals from organisations to investigate the characteristics and capabilities of generating facilities within Great Britain at sites with a registered capacity of less than 5MW. Experience is required in assessing the risks of changing the protection and control arrangements for small and micro-generation where it is deployed in large scales across electricity networks. The working group seeks an independent assessment of the impact of a change to the settings of any Rate of Change of Frequency (RoCoF) based protection.

Scope of Work

The research project must provide a technical report (the technical report will be published on National Grid's website and available to all parties) including:

1. Evaluation of the risk to distribution networks, user equipment and all personnel of change of RoCoF based protection from the current settings to a range of settings up to 1Hzs^{-1} with a measurement period of 500ms;
2. Evaluation of the risk to distribution networks, user equipment and all personnel of abandoning the use of loss of mains protection (eg RoCoF or vector shift) but retaining under and over voltage and frequency protection; and
3. Evaluate the risk of adopting plant type specific

guidance. Items 1-2 are the high level objectives of the

technical report.

Organisations interested in this research project are therefore requested to provide a "formal proposal" including the milestones, and cost associated with each item. The expected completion date for the project is end of August 2014.

¹

<http://www.nationalgrid.com/uk/Electricity/Codes/gridcode/workinggroups/Frequency+Change+s+during+Large+System+Disturbances/>